

## GaAs pHEMT MMIC 2 WATT POWER AMPLIFIER WITH POWER DETECTOR, 12 - 16 GHz



### Typical Applications

The HMC5846LS6 is ideal for:

- Point-to-Point Radios
- Point-to-Multi-Point Radios
- VSAT & SATCOM
- Military & Space

### Features

- Saturated Output Power: 35.5 dBm @ 30% PAE
- High Output IP3: 42.5 dBm
- High Gain: 31 dB
- DC Supply: +7V @ 1200 mA
- No External Matching Required

### Functional Diagram

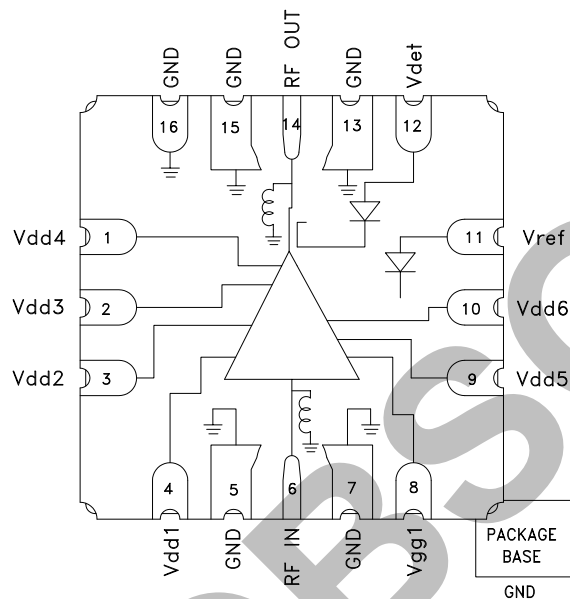

### General Description

The HMC5846LS6 is a 4 stage GaAs pHEMT MMIC 2 Watt Power Amplifier with an integrated temperature compensated power detector which operates between 12 and 16 GHz. The HMC5846LS6 provides 31 dB of gain, 35.5 dBm of saturated output power, and 30% PAE from a +7V supply. The HMC5846LS6 exhibits excellent linearity and is optimized for high capacity digital microwave radio. It is also ideal for 13.75 to 14.5 GHz Ku Band VSAT transmitters as well as SATCOM applications.

### Electrical Specifications, $T_A = +25^\circ\text{C}$

$V_{dd} = V_{dd1}, V_{dd2}, V_{dd3}, V_{dd4}, V_{dd5} = +7V, I_{dd} = 1200\text{ mA}$  [1]

| Parameter  | Min. | Typ.    | Max. | Units  |
|--|------|---------|------|--------|
| Frequency Range  |      | 12 - 16 |      | GHz    |
| Gain   | 26   | 31      |      | dB     |
| Gain Variation Over Temperature                                |      | 0.06    |      | dB/ °C |
| Input Return Loss  |      | 10      |      | dB     |
| Output Return Loss   |      | 17      |      | dB     |
| Output Power for 1 dB Compression (P1dB)                       | 32.5 | 34.5    |      | dBm    |
| Saturated Output Power (P <sub>sat</sub> )                     |      | 35.5    |      | dBm    |
| Output Third Order Intercept (IP <sub>3</sub> ) <sup>[2]</sup> |      | 42.5    |      | dBm    |
| Total Supply Current (I <sub>dd</sub> )                        |      | 1200    |      | mA     |

[1] Adjust V<sub>gg</sub> between -2 to 0V to achieve I<sub>dd</sub> = 1200 mA typical.

[2] Measurement taken at +7V @ 1200 mA, P<sub>out</sub> / Tone = +22 dBm

**GaAs pHEMT MMIC 2 WATT POWER AMPLIFIER  
WITH POWER DETECTOR, 12 - 16 GHz**



**Broadband Gain &  
Return Loss vs. Frequency**

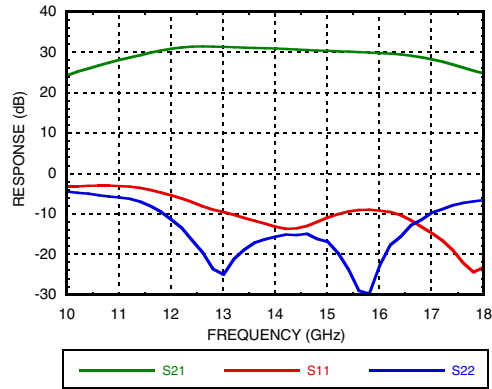

**Gain vs. Temperature**

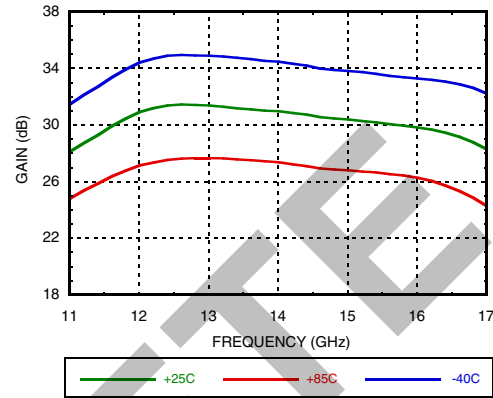

**Input Return Loss vs. Temperature**

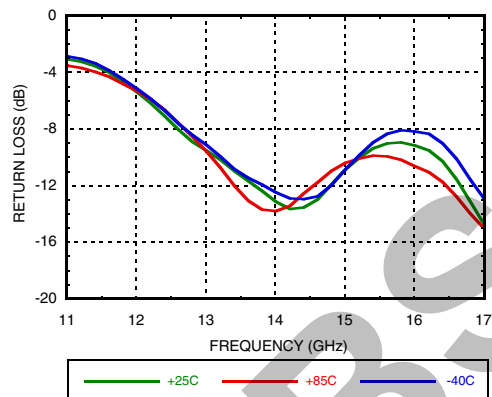

**Output Return Loss vs. Temperature**

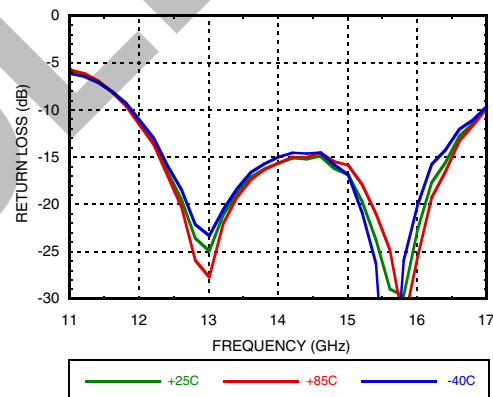

**P1dB vs. Temperature**

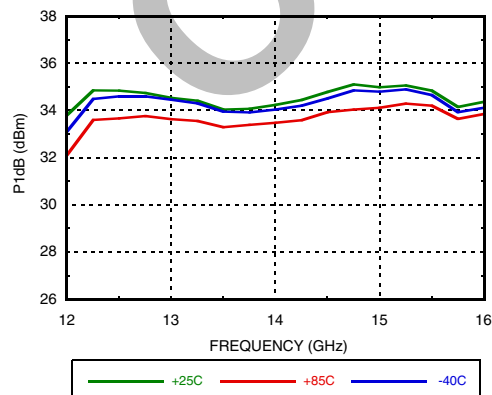

**P1dB vs. Supply Voltage**

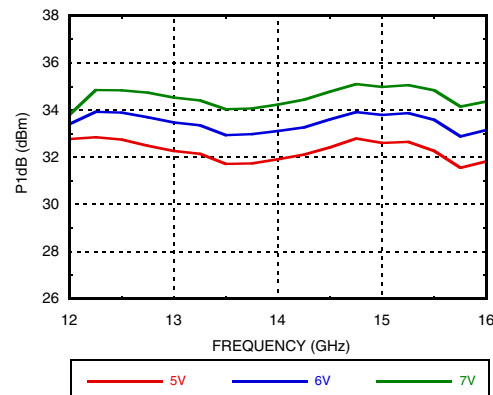

Information furnished by Analog Devices is believed to be accurate and reliable. However, no responsibility is assumed by Analog Devices for its use, nor for any infringements of patents or other rights of third parties that may result from its use. Specifications subject to change without notice. No license is granted by implication or otherwise under any patent or patent rights of Analog Devices. Trademarks and registered trademarks are the property of their respective owners.

For price, delivery, and to place orders: Analog Devices, Inc., One Technology Way, P.O. Box 9106, Norwood, MA 02062-9106 Phone: 781-329-4700 • Order online at [www.analog.com](http://www.analog.com) Application Support: Phone: 1-800-ANALOG-D

**GaAs pHEMT MMIC 2 WATT POWER AMPLIFIER WITH POWER DETECTOR, 12 - 16 GHz**



**Psat vs. Temperature**

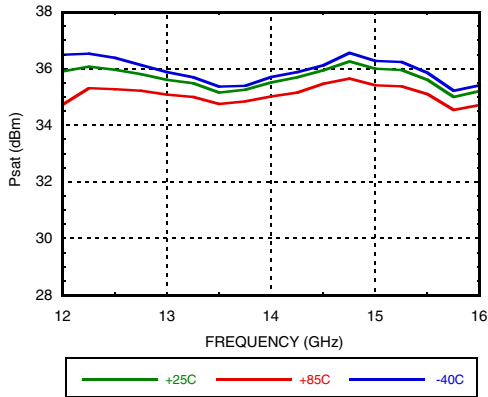

**Psat vs. Supply Voltage**

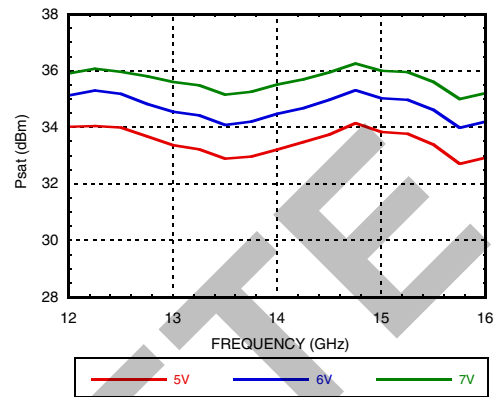

**P1dB vs. Supply Current (Idd)**

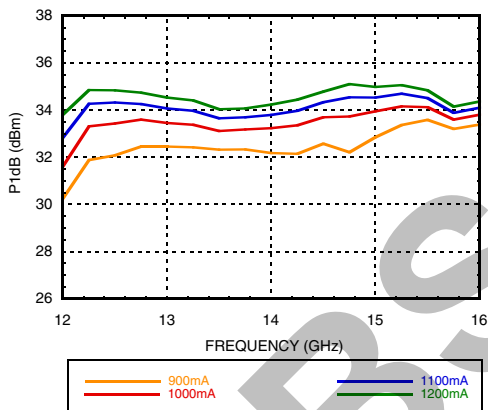

**Psat vs. Supply Current (Idd)**

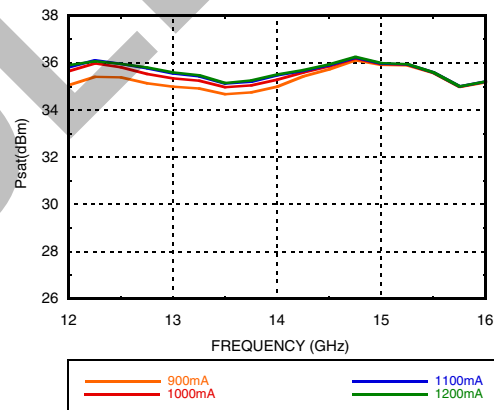

**Output IP3 vs. Temperature, Pout/Tone = +22 dBm**

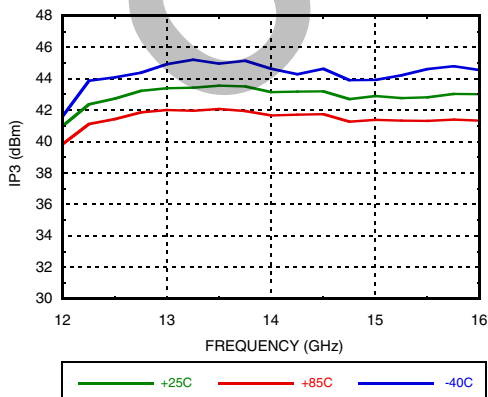

**Output IP3 vs. Supply Current, Pout/Tone = +22 dBm**

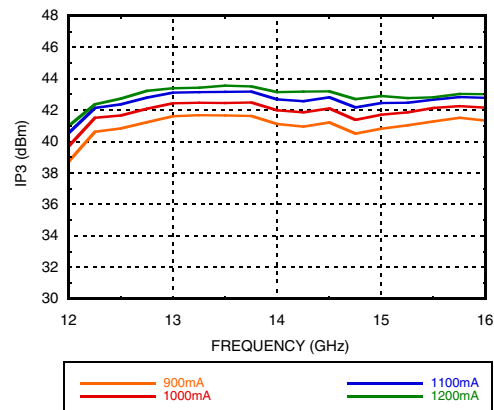

[1] Footnote if needed

Information furnished by Analog Devices is believed to be accurate and reliable. However, no responsibility is assumed by Analog Devices for its use, nor for any infringements of patents or other rights of third parties that may result from its use. Specifications subject to change without notice. No license is granted by implication or otherwise under any patent or patent rights of Analog Devices. Trademarks and registered trademarks are the property of their respective owners.

For price, delivery, and to place orders: Analog Devices, Inc., One Technology Way, P.O. Box 9106, Norwood, MA 02062-9106 Phone: 781-329-4700 • Order online at [www.analog.com](http://www.analog.com) Application Support: Phone: 1-800-ANALOG-D

**GaAs pHEMT MMIC 2 WATT POWER AMPLIFIER WITH POWER DETECTOR, 12 - 16 GHz**



**Output IP3 vs. Supply Voltage, Pout/Tone = +22 dBm**

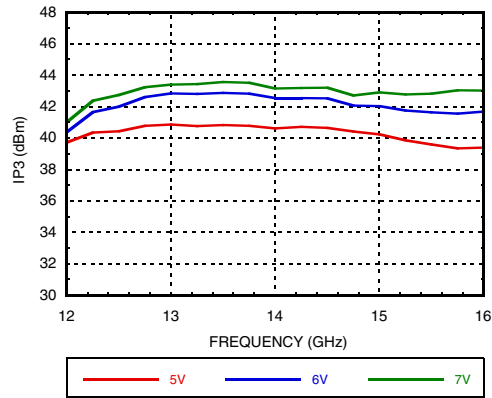

**Output IM3 @ Vdd = +5V**

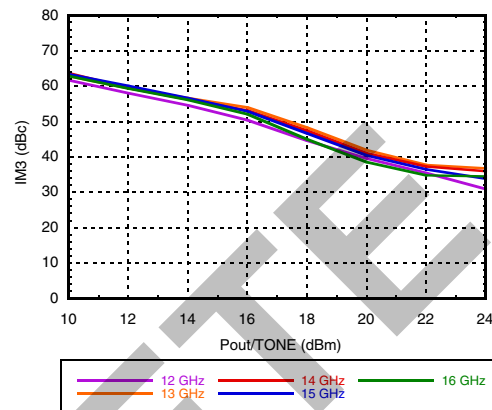

**Output IM3 @ Vdd = +6V**

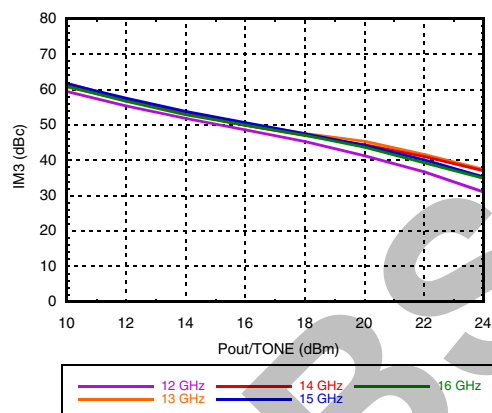

**Output IM3 @ Vdd = +7V**

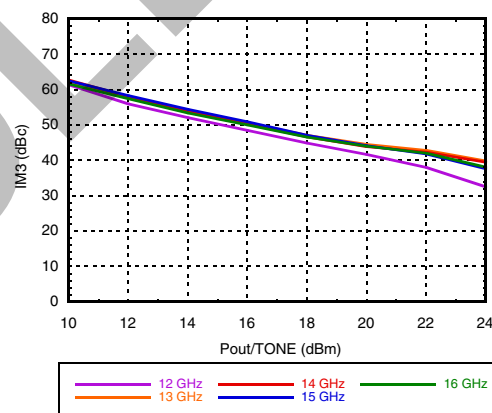

**Power Compression @ 13 GHz**

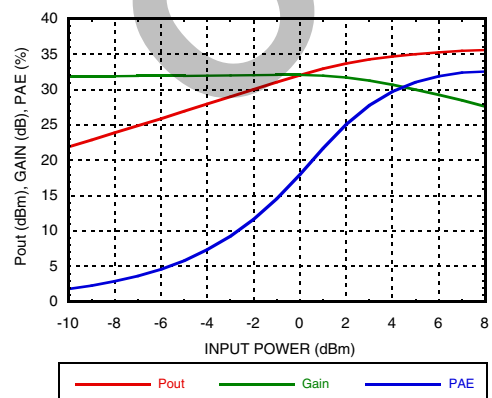

**Power Compression @ 14 GHz**

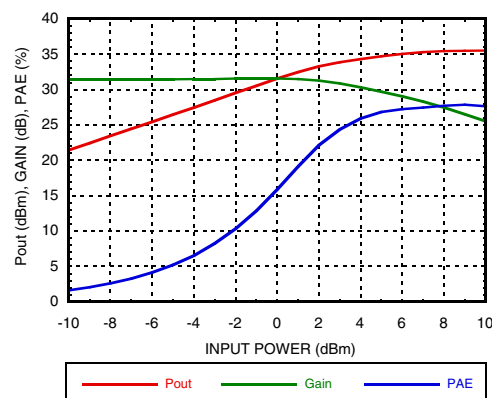

Information furnished by Analog Devices is believed to be accurate and reliable. However, no responsibility is assumed by Analog Devices for its use, nor for any infringements of patents or other rights of third parties that may result from its use. Specifications subject to change without notice. No license is granted by implication or otherwise under any patent or patent rights of Analog Devices. Trademarks and registered trademarks are the property of their respective owners.

For price, delivery, and to place orders: Analog Devices, Inc., One Technology Way, P.O. Box 9106, Norwood, MA 02062-9106 Phone: 781-329-4700 • Order online at [www.analog.com](http://www.analog.com) Application Support: Phone: 1-800-ANALOG-D

**GaAs pHEMT MMIC 2 WATT POWER AMPLIFIER WITH POWER DETECTOR, 12 - 16 GHz**



**Power Compression @ 15 GHz**

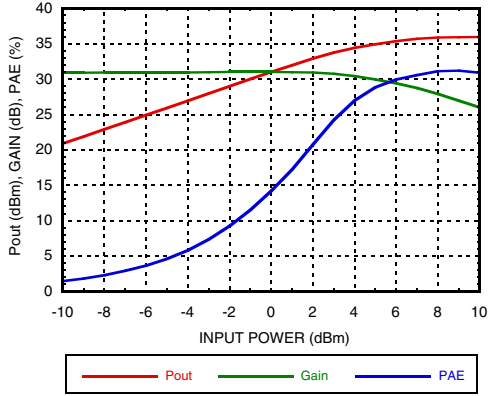

**Detector Voltage Over Temperature**

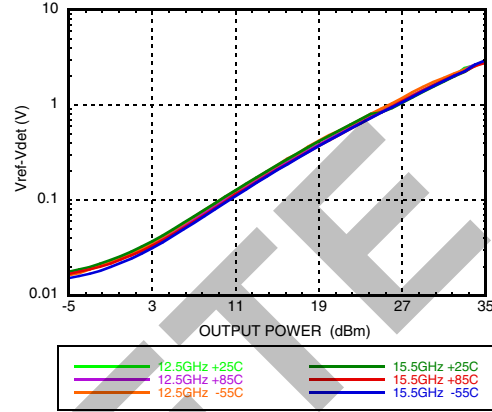

**Reverse Isolation vs. Temperature**

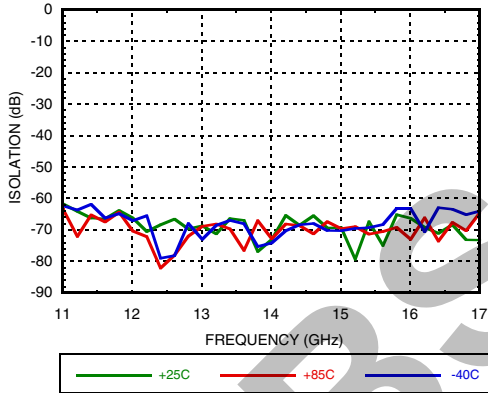

**Gain & Power vs. Supply Current @ 14 GHz**

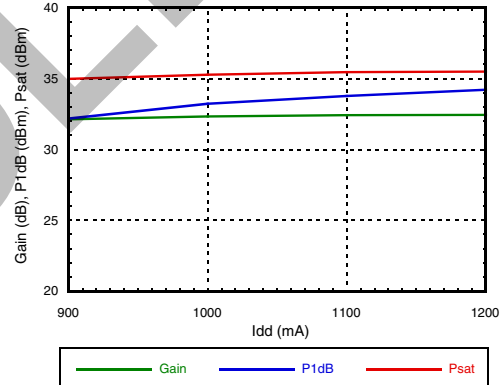

**Gain & Power vs. Supply Voltage @ 14 GHz**

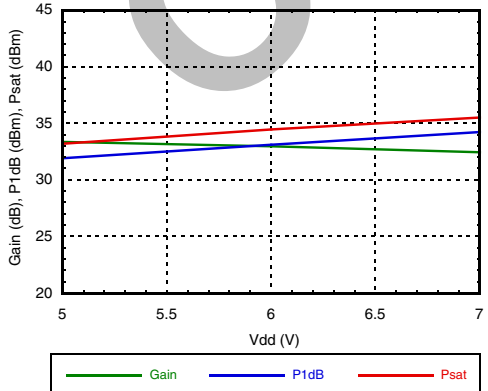

**Power Dissipation**

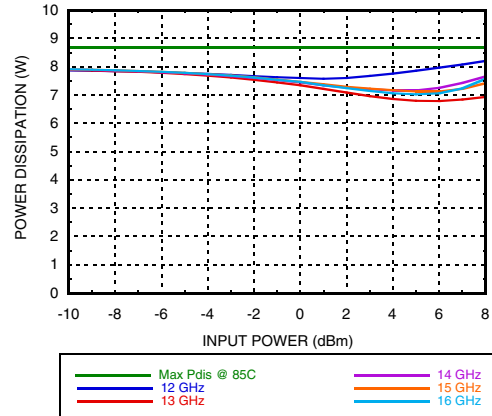

Information furnished by Analog Devices is believed to be accurate and reliable. However, no responsibility is assumed by Analog Devices for its use, nor for any infringements of patents or other rights of third parties that may result from its use. Specifications subject to change without notice. No license is granted by implication or otherwise under any patent or patent rights of Analog Devices. Trademarks and registered trademarks are the property of their respective owners.

For price, delivery, and to place orders: Analog Devices, Inc., One Technology Way, P.O. Box 9106, Norwood, MA 02062-9106 Phone: 781-329-4700 • Order online at [www.analog.com](http://www.analog.com) Application Support: Phone: 1-800-ANALOG-D

## GaAs pHEMT MMIC 2 WATT POWER AMPLIFIER WITH POWER DETECTOR, 12 - 16 GHz



### Absolute Maximum Ratings

|   |                    |
|---|--------------------|
| Drain Bias Voltage (Vdd)                                      | +8V                |
| RF Input Power (RFIN)   | +24 dBm            |
| Channel Temperature   | 150 °C             |
| Continuous Pdiss (T= 85 °C)<br>(derate 133 mW/°C above 85 °C) | 8.6 W              |
| Thermal Resistance<br>(channel to ground paddle)              | 7.55 °C/W          |
| Storage Temperature   | -65 to +150 °C     |
| Operating Temperature   | -55 to +85 °C      |
| ESD Sensitivity (HBM)   | Class 1A Pass 250V |

### Reliability Information

|   |               |
|---|---------------|
| Junction Temperature to Maintain<br>1 Million Hour MTTF     | 150 °C        |
| Nominal Junction Temperature<br>(T= 85 °C and Pin = 10 dBm) | 90 °C         |
| Operating Temperature                                       | -55 to +85 °C |



ELECTROSTATIC SENSITIVE DEVICE  
OBSERVE HANDLING PRECAUTIONS

### Outline Drawing

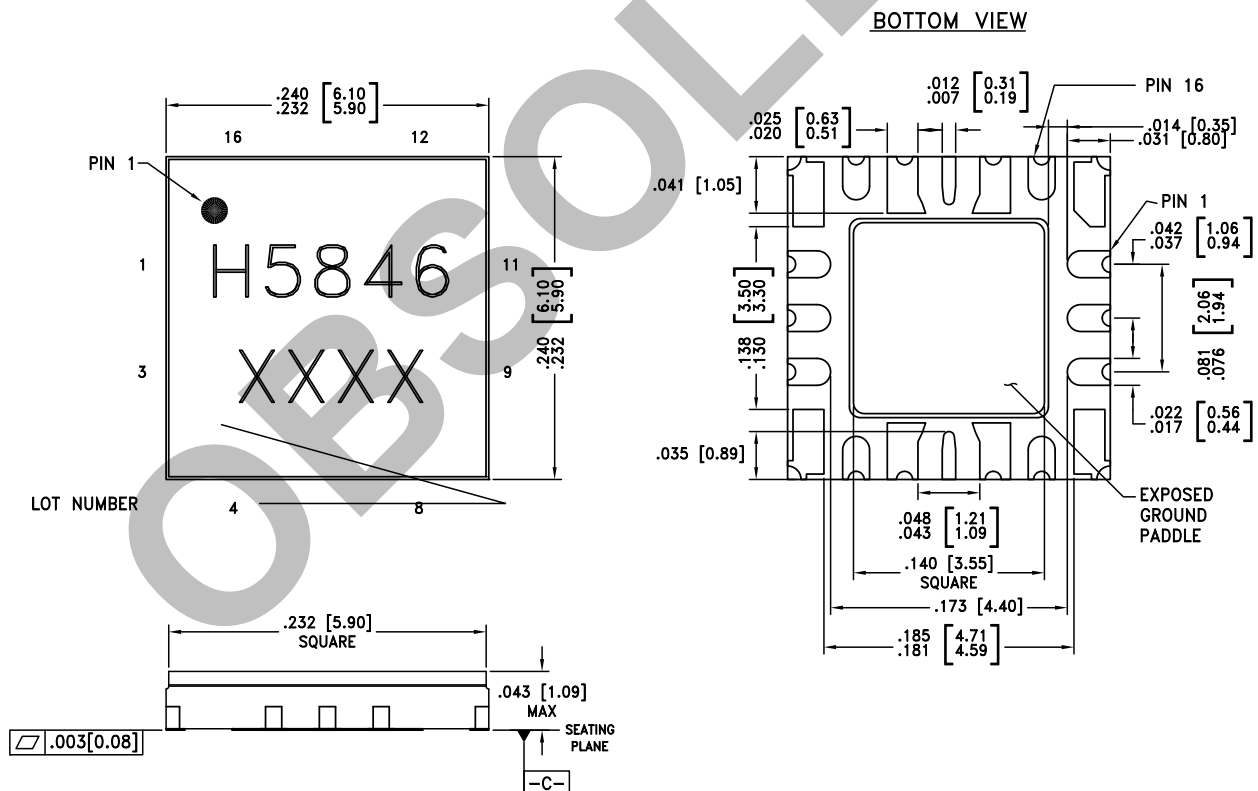

### Package Information

| Part Number | Package Body Material | Lead Finish      | MSL Rating [2] | Package Marking [1] |
|-------------|-----------------------|------------------|----------------|---------------------|
| HMC5846LS6  | ALUMINA WHITE         | Gold over Nickel | N/A            | H5846<br>XXXX       |

[1] 4-Digit lot number XXXX

[2] Max peak reflow temperature of 260 °C

Information furnished by Analog Devices is believed to be accurate and reliable. However, no responsibility is assumed by Analog Devices for its use, nor for any infringements of patents or other rights of third parties that may result from its use. Specifications subject to change without notice. No license is granted by implication or otherwise under any patent or patent rights of Analog Devices. Trademarks and registered trademarks are the property of their respective owners.

For price, delivery, and to place orders: Analog Devices, Inc., One Technology Way, P.O. Box 9106, Norwood, MA 02062-9106  
Phone: 781-329-4700 • Order online at [www.analog.com](http://www.analog.com)  
Application Support: Phone: 1-800-ANALOG-D

**GaAs pHEMT MMIC 2 WATT POWER AMPLIFIER WITH POWER DETECTOR, 12 - 16 GHz**



**Pin Descriptions**

| Pad Number       | Function                           | Description  | Interface Schematic |
|------------------|------------------------------------|--|---------------------|
| 6                | RFIN                               | This Pin is DC coupled and matched to 50 Ohms over the operating frequency.  |                     |
| 1-4<br>9, 10     | Vdd4, Vdd3, Vdd2, Vdd1, Vdd5, Vdd6 | Drain bias voltage for the amplifier. External bypass capacitors of 100 pF are required for each pin followed by 0.01 μF capacitors and a 4.7 μF capacitors. |                     |
| 8                | Vgg1                               | Gate controlled amplifier. External bypass capacitors of 100 pF are required followed by 0.01 μF capacitors and a 4.7 μF capacitors.                         |                     |
| 5, 7, 13, 15, 16 | GND                                | These Pins and Package bottom must be connected to RF/DC ground.   |                     |
| 11               | Vref                               | DC voltage of diode biased through external resistor, used for temperature compensation of Vdet.   |                     |
| 12               | Vdet                               | DC voltage representing RF output rectified by diode which is biased through an external resistor.   |                     |
| 14               | RFOUT                              | This Pin is DC coupled and matched to 50 Ohms.   |                     |

**Application Circuit**

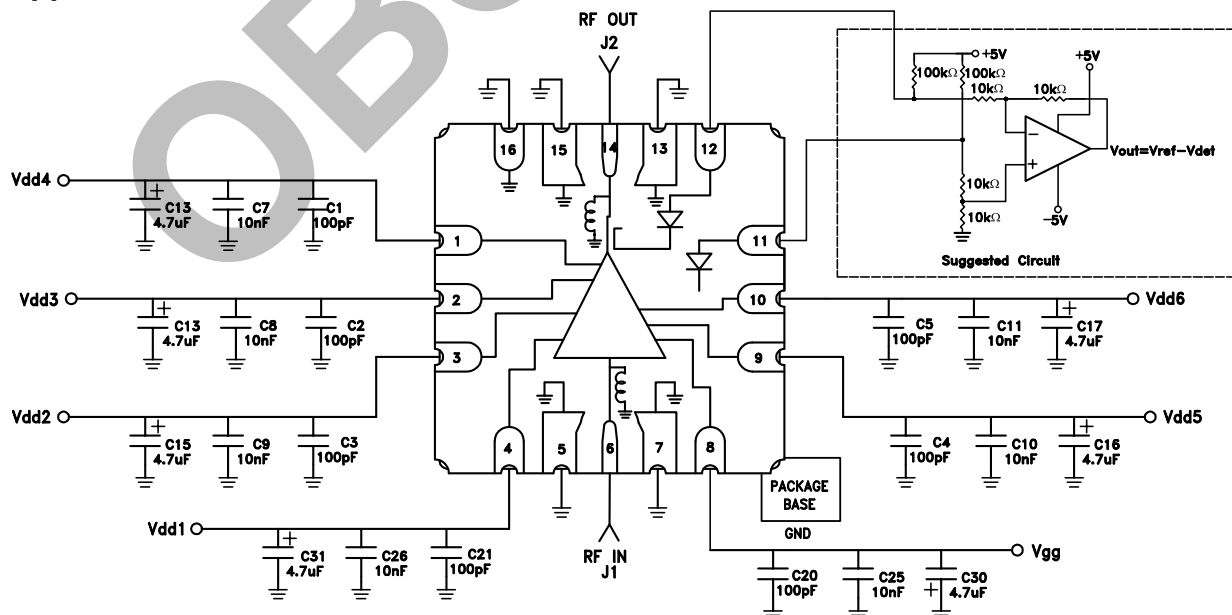

Information furnished by Analog Devices is believed to be accurate and reliable. However, no responsibility is assumed by Analog Devices for its use, nor for any infringements of patents or other rights of third parties that may result from its use. Specifications subject to change without notice. No license is granted by implication or otherwise under any patent or patent rights of Analog Devices. Trademarks and registered trademarks are the property of their respective owners.

For price, delivery, and to place orders: Analog Devices, Inc., One Technology Way, P.O. Box 9106, Norwood, MA 02062-9106 Phone: 781-329-4700 • Order online at [www.analog.com](http://www.analog.com) Application Support: Phone: 1-800-ANALOG-D

AMPLIFIERS - LINEAR & POWER - SMT

**GaAs pHEMT MMIC 2 WATT POWER AMPLIFIER  
WITH POWER DETECTOR, 12 - 16 GHz**



**Evaluation PCB**

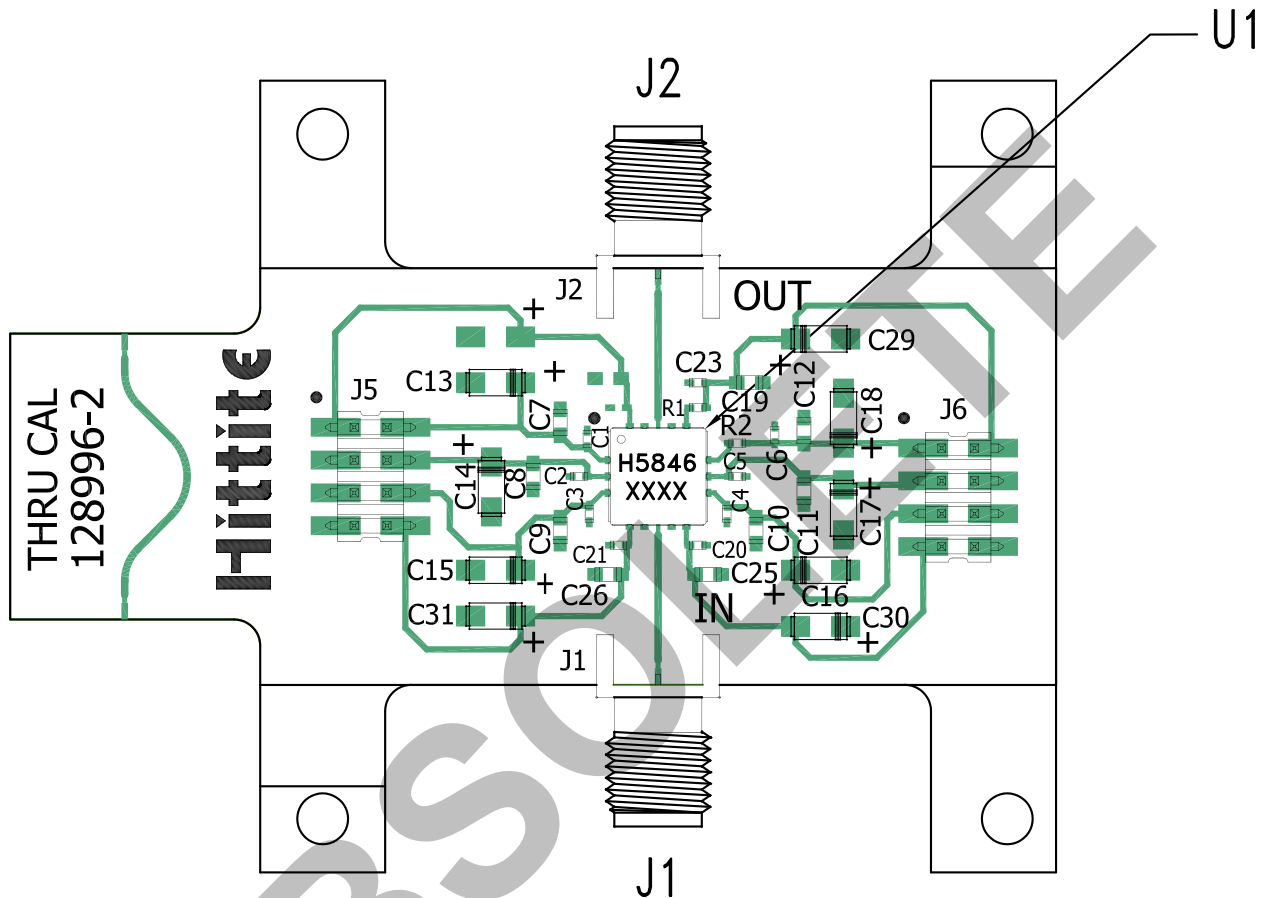

**List of Materials for Evaluation PCB EVAL01-HMC5846LS6 [1]**

| Item                    | Description                         |
|-------------------------|-------------------------------------|
| J1, J2                  | PCB Mount K Connectors, SRI         |
| J5, J6                  | DC Pins                             |
| C1 - C6, C20, C21, C23  | 100 pF Capacitors, 0402 Pkg.        |
| C7 - C12, C19, C25, C26 | 0.01 $\mu$ F Capacitors, 0603 Pkg.  |
| C13 - C18, C29 - C31    | 4.7 $\mu$ F Capacitors, Case A Pkg. |
| R1 - R2                 | 40.2 kOhm Resistor, 0402 Pkg.       |
| U1                      | HMC5846LS6 Amplifier                |
| PCB [2]                 | 128996 Evaluation PCB               |

[1] Reference this number when ordering complete evaluation PCB

[2] Circuit Board Material: Rogers 4350

The circuit board used in the application should use RF circuit design techniques. Signal lines should have 50 Ohm impedance while the package ground leads and exposed paddle should be connected directly to the ground plane similar to that shown. A sufficient number of via holes should be used to connect the top and bottom ground planes. The evaluation board should be mounted to an appropriate heat sink. The evaluation circuit board shown is available from Hittite upon request.