

Features

- RoHS compliant*
- SMA package
- Surface mount
- Very low forward voltage drop



The Model CD214A-B1xR Series is the recommended replacement.

CD214A-B120 ~ B1100 Schottky Barrier Rectifier Chip Diode

General Information

The markets of portable communications, computing and video equipment are challenging the semiconductor industry to develop increasingly smaller electronic components.

Bourns offers Schottky Rectifier Diodes for rectification applications, in compact chip package DO-214AC (SMA) size format, which offer PCB real estate savings and are considerably smaller than competitive parts. The Schottky Rectifier Diodes offer a forward current of 1 A with a choice of repetitive peak reverse voltage of 20 V up to 100 V.

Bourns® Chip Diodes conform to JEDEC standards, are easy to handle on standard pick and place equipment and their flat configuration minimizes roll away.

Electrical Characteristics (@ T_A = 25 °C Unless Otherwise Noted)

Parameter	Symbol	CD214A-											Unit
		B120	B120L	B130	B130L	B140	B150	B160	B170	B180	B190	B1100	
Forward Voltage (Max.) (I _f = 1 A)	V _F	0.5	0.41	0.5	0.41	0.5	0.7	0.7	0.79	0.79	0.79	0.79	V
Typical Junction Capacitance**	C _T	110	100	110	100	110	110	110	30	30	30	30	pF
Reverse Current (Max.) at Rated V _R)	I _R	500	1000	500	1000	500	500	500	500	500	500	500	μA

** Measured at 1.0 MHz and applied reverse voltage of 4.0 VDC.

Absolute Ratings (@ T_A = 25 °C Unless Otherwise Noted)

Parameter	Symbol	CD214A-											Unit
		B120	B120L	B130	B130L	B140	B150	B160	B170	B180	B190	B1100	
Repetitive Peak Reverse Voltage	V _{RRM}	20	20	30	30	40	50	60	70	80	90	100	V
Reverse Voltage	V _R	20	20	30	30	40	50	60	70	80	90	100	V
Maximum RMS Voltage	V _{RMS}	14	14	21	21	28	35	42	49	56	63	70	V
Avg. Forward Current	I _O	1											A
Forward Current, Surge Peak (60 Hz, 1 cycle)	I _{surge}	30	25	30	25	30	30	30	30	30	30	30	A
Typical Thermal Resistance***	R _{θJL}	20	35	20	35	20	20	20	25	25	25	25	°C/W
Storage Temperature	T _{STG}	-55 to +150											°C
Junction Temperature	T _J	-55 to +125											°C

*** Thermal resistance junction to lead.

BOURNS®

Asia-Pacific: Tel: +886-2 2562-4117 • Email: asiacus@bourns.com

EMEA: Tel: +36 88 520 390 • Email: eurocus@bourns.com

The Americas: Tel: +1-951 781-5500 • Email: americus@bourns.com

www.bourns.com

*RoHS Directive 2002/95/EC Jan. 27, 2003 including annex and RoHS Recast 2011/65/EU June 8, 2011.

Specifications are subject to change without notice.

The device characteristics and parameters in this data sheet can and do vary in different applications and actual device performance may vary over time.

Users should verify actual device performance in their specific applications.

How to Order

Common Code	CD 214A - B 1 30 L LF
Chip Diode	
Package	214A = SMA/DO-214AC
Model	B = Schottky Barrier Series
Average Forward Current (I _O) Code	1 = 1 A (Code x 1000 mA = Average Forward Current)
Reverse Voltage (V _R) Code	30 = 30 V 40 = 40 V 100 = 100 V
Forward Voltage Suffix (Applies to -B120L & -B130L only)	L = Low Forward Voltage V _f (-B120L & -B130L only) No Space in P/N = Not Low Forward Voltage
Terminations	LF = 100 % Sn (RoHS Compliant*)

CD214A-B120 ~ B1100 Schottky Barrier Rectifier Chip Diode



Product Dimensions

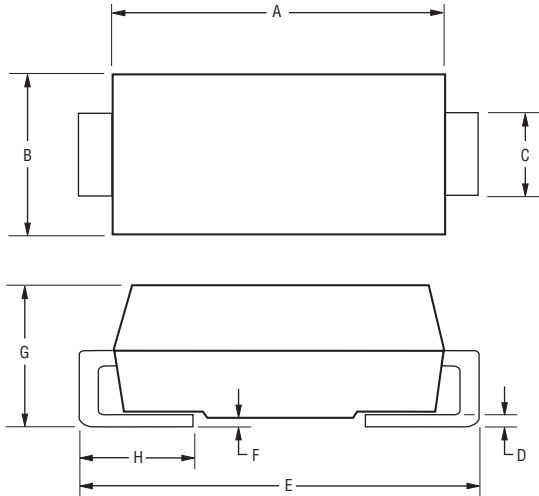

Dimension	SMA (DO-214AC)
A	$\frac{4.06 - 4.57}{(0.160 - 0.180)}$
B	$\frac{2.29 - 2.92}{(0.090 - 0.115)}$
C	$\frac{1.27 - 1.63}{(0.050 - 0.064)}$
D	$\frac{0.15 - 0.31}{(0.006 - 0.110)}$
E	$\frac{4.83 - 5.59}{(0.190 - 0.220)}$
F	$\frac{0.05 - 0.20}{(0.002 - 0.008)}$
G	$\frac{2.01 - 2.62}{(0.080 - 0.103)}$
H	$\frac{0.76 - 1.52}{(0.030 - 0.060)}$

DIMENSIONS: $\frac{\text{MM}}{\text{(INCHES)}}$

Recommended Pad Layout

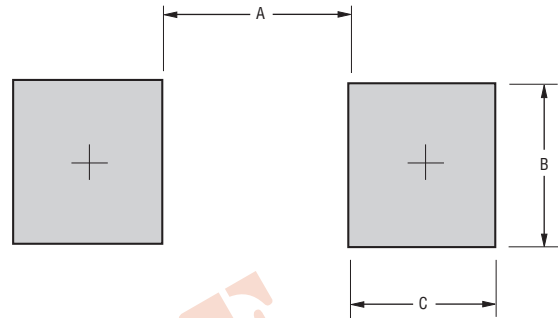

Dimension	SMA (DO-214AC)
A	$\frac{2.90}{(0.114)}$
B	$\frac{2.40}{(0.094)}$
C	$\frac{2.30}{(0.091)}$

DIMENSIONS: $\frac{\text{MM}}{\text{(INCHES)}}$

Physical Specifications

Case Molded plastic
 Polarity..... Indicated by cathode band
 Weight 0.002 ounces / 0.064 grams

Typical Part Marking

CD214A-B120	B 120
CD214A-B120L	B 120L
CD214A-B130	B 130
CD214A-B130L	B 130L
CD214A-B140	B 140
CD214A-B150	B 150
CD214A-B160	B 160
CD214A-B170	B 170
CD214A-B180	B 180
CD214A-B190	B 190
CD214A-B1100.....	B 1100

Specifications are subject to change without notice.
 The device characteristics and parameters in this data sheet can and do vary in different applications and actual device performance may vary over time.
 Users should verify actual device performance in their specific applications.

CD214A-B120 ~ B1100 Schottky Barrier Rectifier Chip Diode



Rating and Characteristic Curves: CD214A-B120, CD214A-B130, CD214A-B140, CD214A-B150 & CD214A-B160

Forward Characteristics

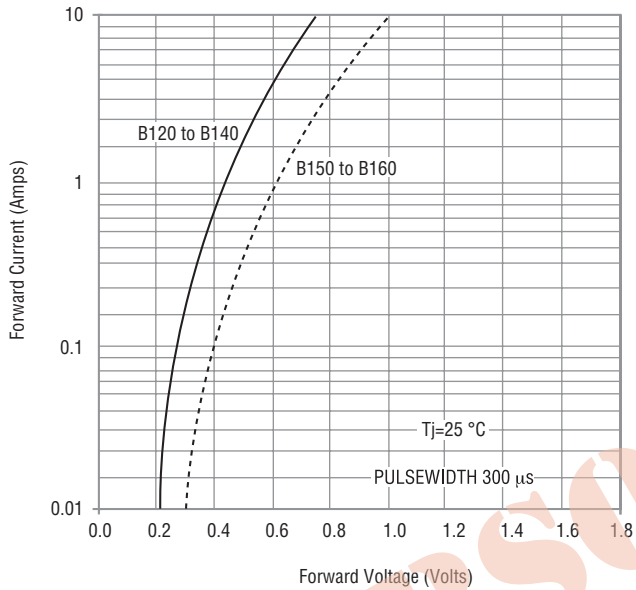

Reverse Characteristics

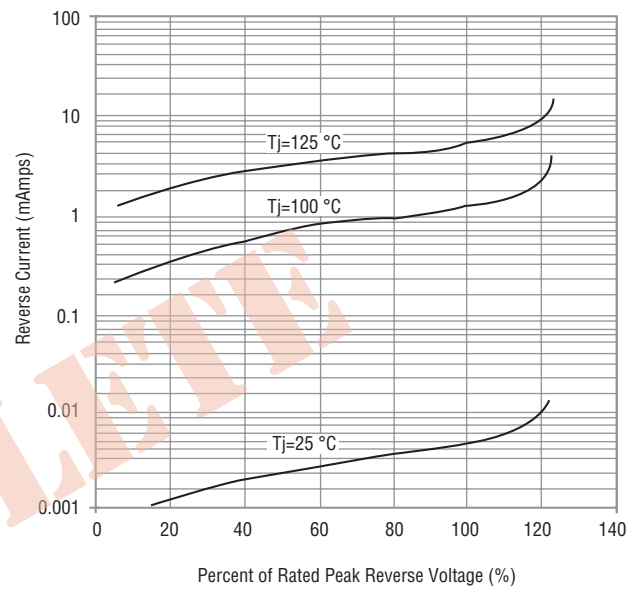

Derating Curve

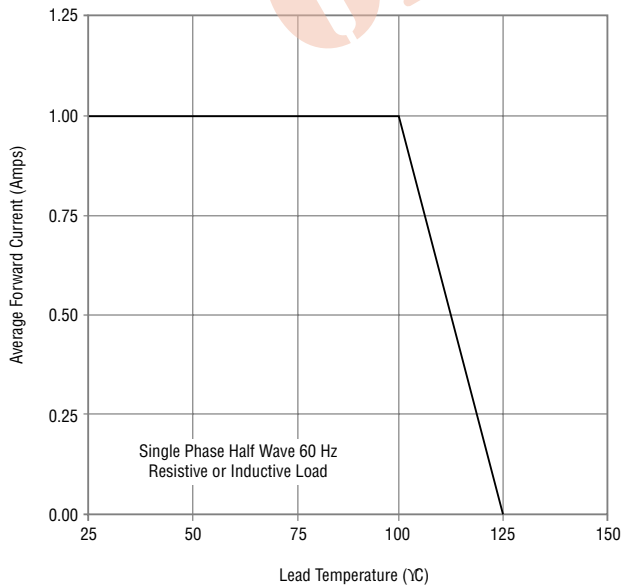

Capacitance Between Terminals

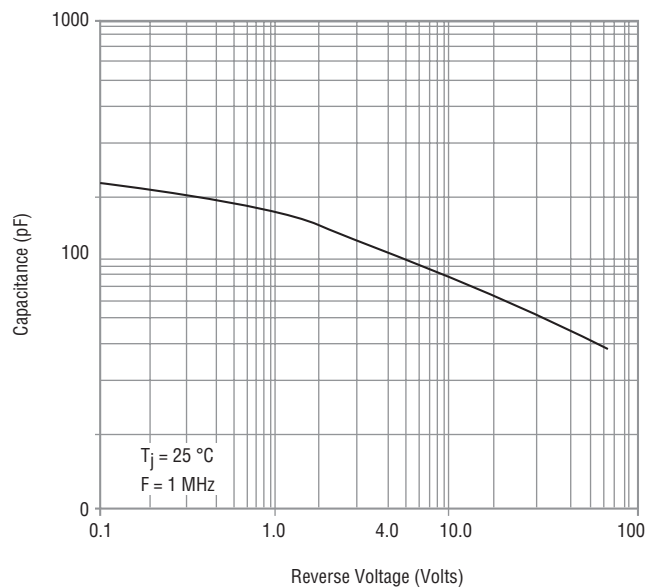

Specifications are subject to change without notice.

The device characteristics and parameters in this data sheet can and do vary in different applications and actual device performance may vary over time. Users should verify actual device performance in their specific applications.

CD214A-B120 ~ B1100 Schottky Barrier Rectifier Chip Diode **BOURNS®**

Rating and Characteristic Curves: CD214A-B120L, CD214A-B130L

Forward Characteristics

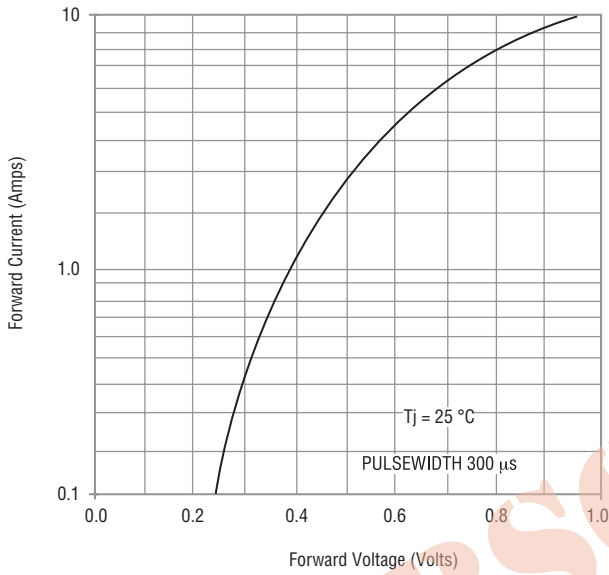

Reverse Characteristics

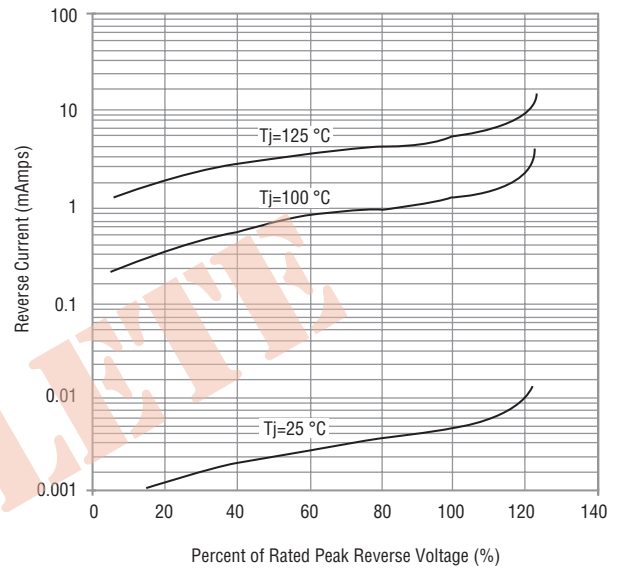

Derating Curve

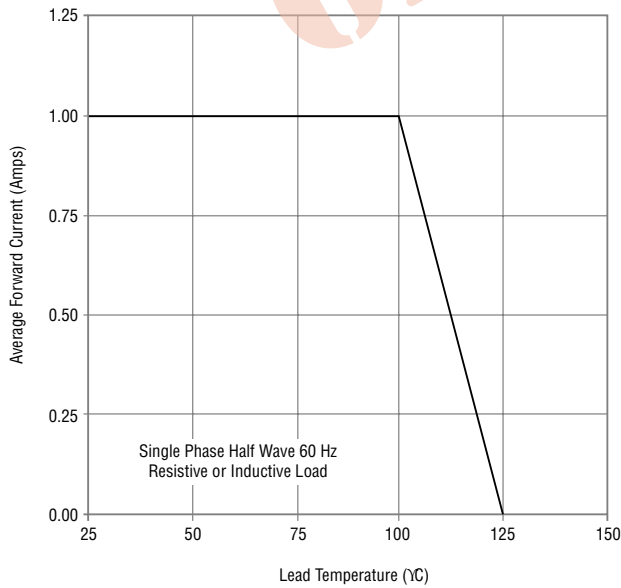

Capacitance Between Terminals

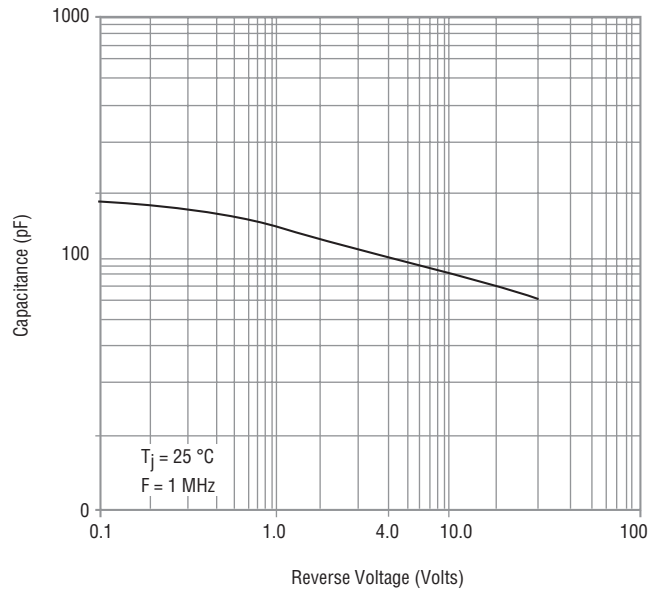

Specifications are subject to change without notice.

The device characteristics and parameters in this data sheet can and do vary in different applications and actual device performance may vary over time. Users should verify actual device performance in their specific applications.

CD214A-B120 ~ B1100 Schottky Barrier Rectifier Chip Diode **BOURNS®**

Rating and Characteristic Curves: CD214A-B170, CD214A-B180, CD214A-B190 & CD214A-B1100

Forward Characteristics

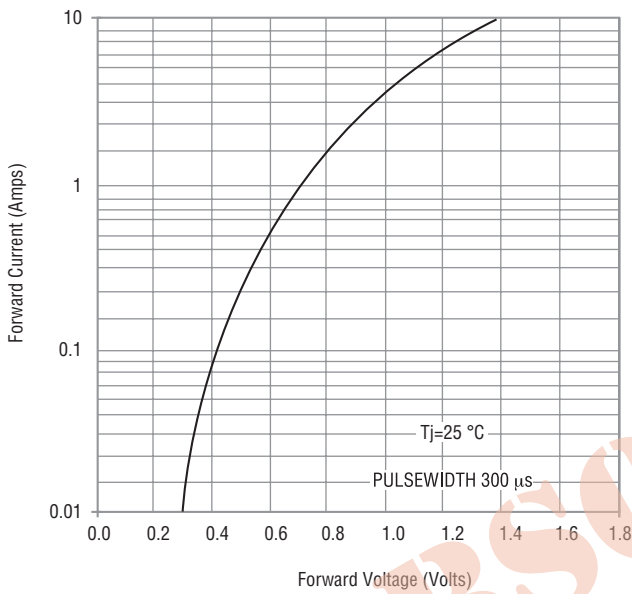

Reverse Characteristics

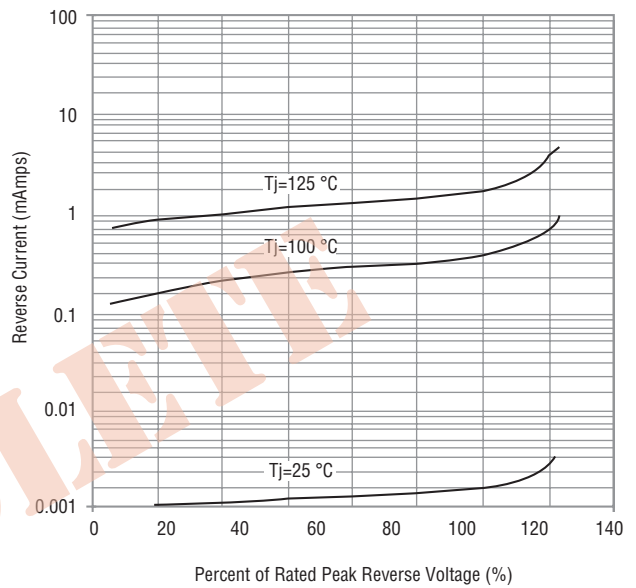

Derating Curve

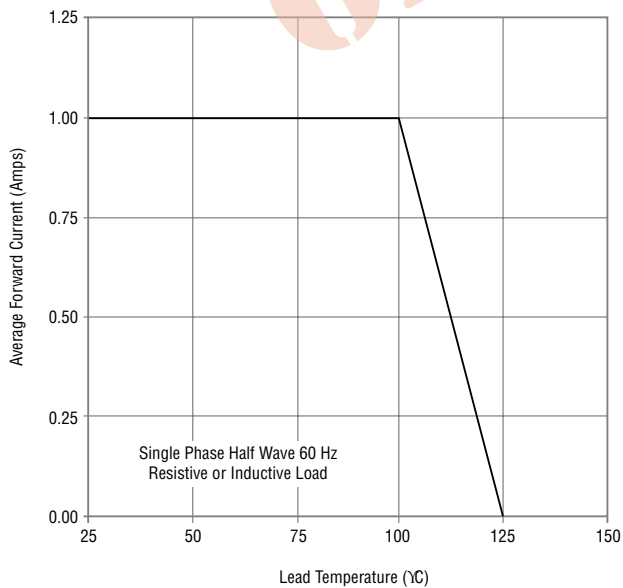

Capacitance Between Terminals

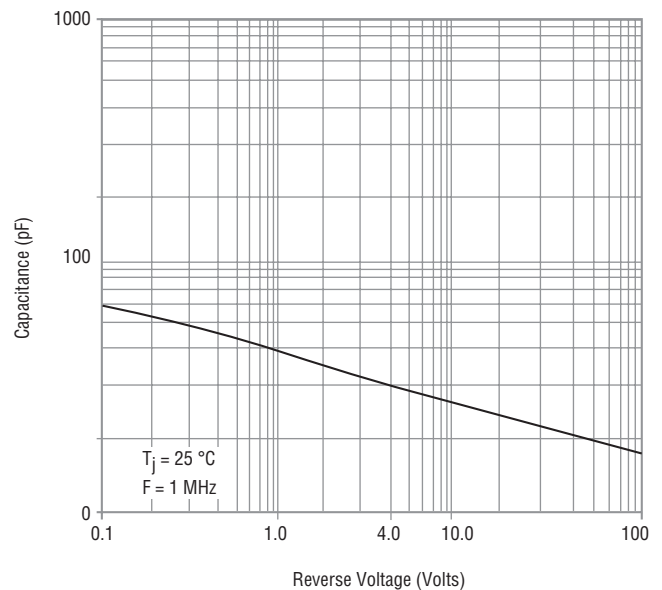

Specifications are subject to change without notice.

The device characteristics and parameters in this data sheet can and do vary in different applications and actual device performance may vary over time. Users should verify actual device performance in their specific applications.

CD214A-B120 ~ B1100 Schottky Barrier Rectifier Chip Diode

BOURNS®

Packaging Information

The product is dispensed in tape and reel format (see diagram below).

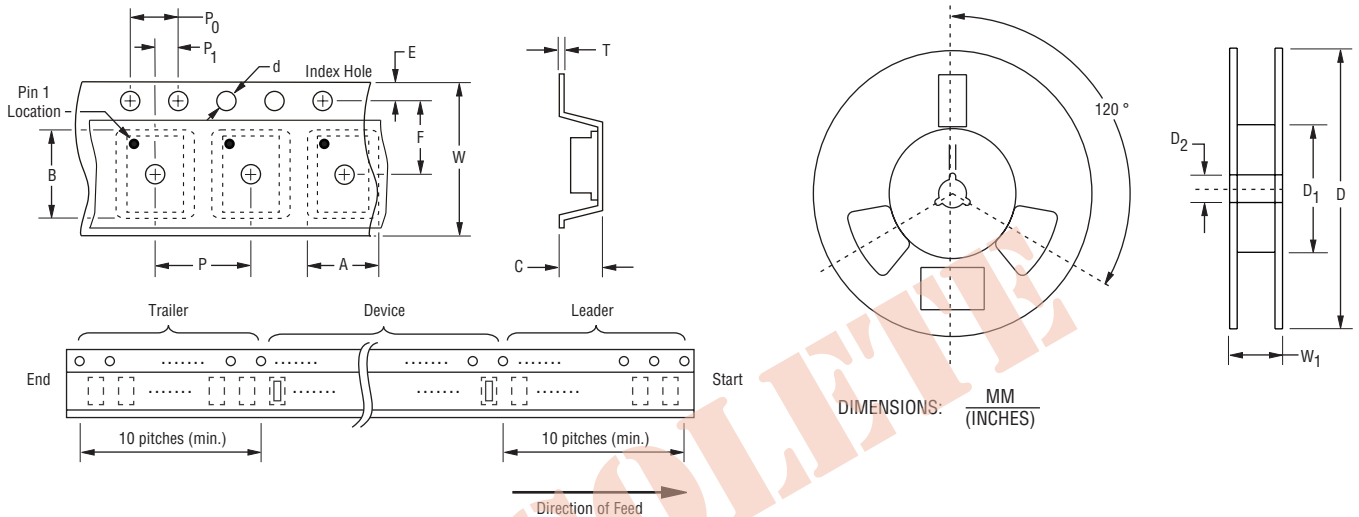

Devices are packed in accordance with EIA standard RS-481-A and specifications shown here.

Item	Symbol	SMA (DO-214AC)
Carrier Width	A	$\frac{2.90 \pm 0.10}{(0.114 \pm 0.004)}$
Carrier Length	B	$\frac{5.59 \pm 0.10}{(0.220 \pm 0.004)}$
Carrier Depth	C	$\frac{2.36 \pm 0.10}{(0.093 \pm 0.004)}$
Sprocket Hole	d	$\frac{1.55 \pm 0.05}{(0.061 \pm 0.002)}$
Reel Outside Diameter	D	$\frac{3.30}{(12.992)}$
Reel Inner Diameter	D ₁	$\frac{50.0}{(1.969)}$ MIN.
Feed Hole Diameter	D ₂	$\frac{13.0 \pm 0.20}{(0.512 \pm 0.008)}$
Sprocket Hole Position	E	$\frac{1.75 \pm 0.10}{(0.069 \pm 0.004)}$
Punch Hole Position	F	$\frac{5.50 \pm 0.05}{(0.217 \pm 0.002)}$
Punch Hole Pitch	P	$\frac{4.00 \pm 0.10}{(0.157 \pm 0.004)}$
Sprocket Hole Pitch	P ₀	$\frac{4.00 \pm 0.10}{(0.157 \pm 0.004)}$
Embossment Center	P ₁	$\frac{2.00 \pm 0.05}{(0.079 \pm 0.002)}$
Overall Tape Thickness	T	$\frac{0.30 \pm 0.10}{(0.012 \pm 0.004)}$
Tape Width	W	$\frac{12.00 \pm 0.20}{(0.472 \pm 0.008)}$
Reel Width	W ₁	$\frac{18.4}{(0.724)}$ MAX.
Quantity per Reel	--	5,000

REV. 01/18

Specifications are subject to change without notice. Users should verify actual device performance in their specific applications.

The device characteristics and parameters in this data sheet can and do vary in different applications and actual device performance may vary over time.