

*RoHS COMPLIANT

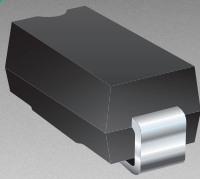

BOURNS®

Features

- RoHS Compliant*
- Low reverse leakage current
- Low forward voltage drop
- High current capability



The Model CD214B-FS3x Series is the recommended replacement.

CD214B-F350~F3600 Surface Mount Fast Response Rectifiers

General Information

The markets of portable communications, computing and video equipment are challenging the semiconductor industry to develop increasingly smaller electronic components. Bourns offers Glass Passivated Rectifiers for rectification applications, in compact chip DO-214AA (SMB) size format, which offers PCB real estate savings and are considerably smaller than most competitive parts. The Glass Passivated Rectifier Diodes offer a forward current of 3.0 A with a choice of repetitive peak reverse voltage of 50 V up to 600 V.

Bourns® Chip Diodes conform to JEDEC standards, are easy to handle on standard pick and place equipment and their flat configuration minimizes roll away.

Electrical Characteristics (@ T_A = 25 °C Unless Otherwise Noted)

Parameter	Symbol	CD214B-						Unit
		F350	F3100	F3150	F3200	F3400	F3600	
Maximum Repetitive Peak Reverse Voltage	V _{RRM}	50	100	150	200	400	600	V
Maximum RMS Voltage	V _{RMS}	35	70	105	140	280	420	V
Maximum DC Blocking Voltage	V _{DC}	50	100	150	200	400	600	V
Maximum Average Forward Rectified Current ¹	I _(AV)	3.0						A
DC Reverse Current @ Rated DC Blocking Voltage (@T _J = 25 °C)	I _R	5.0						μA
DC Reverse Current @ Rated DC Blocking Voltage (@T _J = 125 °C)	I _R	120.0						μA
Typical Junction Capacitance ²	C _J	10						pF
Maximum Instantaneous Forward Voltage @ 1 A	V _F	0.95			1.25		1.7	V
Typical Thermal Resistance ³	R _{θJA}	34						°C/W
Peak forward surge current 8.3 ms single half sine-wave superimposed on rated load (JEDEC Method)	I _{FSM}	100						A
Maximum Reverse Recovery Time ⁴	T _{rr}	35						ns

Notes:

1 See Forward Derating Curve.

2 Measured at 1 MHz and an applied reverse voltage of 4.0 V.

3 Thermal resistance from junction to ambient and from junction to lead P.C.B. mounted on 0.2 x 0.2" (5.0 x 5.0 mm) copper pad areas.

4 Reverse recovery test condition: I_F = 0.5 A, I_R = 1.0 A, I_{rr} = 0.25 A

Thermal Characteristics (@ T_A = 25 °C Unless Otherwise Noted)

Parameter	Symbol	CD214B-F350~F3600	Unit
Operating Temperature Range	T _J	-55 to +150	°C
Storage Temperature Range	T _{STG}	-55 to +150	°C

*RoHS Directive 2002/95/EC Jan. 27, 2003 including annex and RoHS Recast 2011/65/EU June 8, 2011.

Specifications are subject to change without notice.

The device characteristics and parameters in this data sheet can and do vary in different applications and actual device performance may vary over time.

Users should verify actual device performance in their specific applications.

CD214B-F350~F3600 Surface Mount Fast Response Rectifiers



Product Dimensions

This is an RoHS compliant product. It is a molded plastic package. A cathode band indicates the polarity. The package weighs approximately 0.064 g. The package and dimensions are shown below.

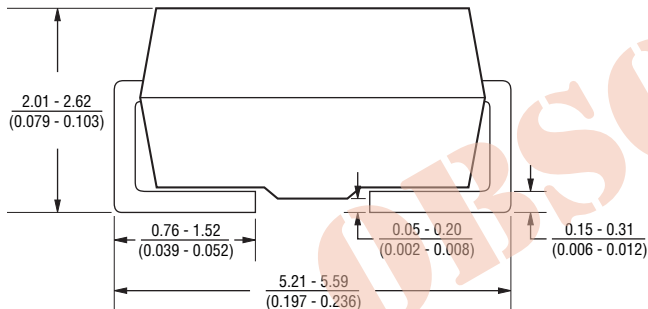
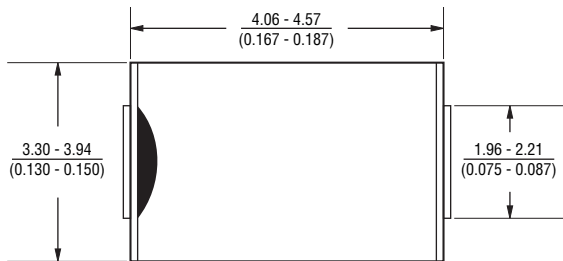

How To Order

CD 214B - F 3 50

Common Code _____
 CD = Chip Diode
 Package _____
 214B = SMB/DO-214AA
 Model Series _____
 F = Fast Response Rectifier
 Forward Current I_{AV} _____
 3 = 3 A
 Reverse Voltage _____
 50 = 50 V
 100 = 100 V
 150 = 150 V
 200 = 200 V
 400 = 400 V
 600 = 600 V

Typical Part Marking

CD214B-F350	F3A
CD214B-F3100	F3B
CD214B-F3150	F3C
CD214B-F3200	F3D
CD214B-F3400	F3G
CD214B-F3600	F3J

Recommended Pad Layout

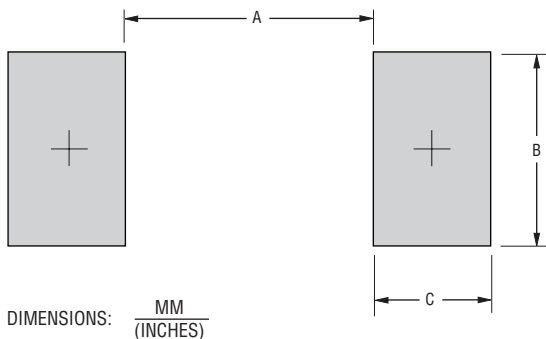

Dimension	SMA (DO-214AC)
A	$\frac{2.90}{(0.114)}$
B	$\frac{3.00}{(0.118)}$
C	$\frac{2.30}{(0.091)}$

Specifications are subject to change without notice.
 The device characteristics and parameters in this data sheet can and do vary in different applications and actual device performance may vary over time.
 Users should verify actual device performance in their specific applications.

CD214B-F350~F3600 Surface Mount Fast Response Rectifiers

BOURNS®

Packaging Information

The product will be dispensed in Tape and Reel format (see diagram below).

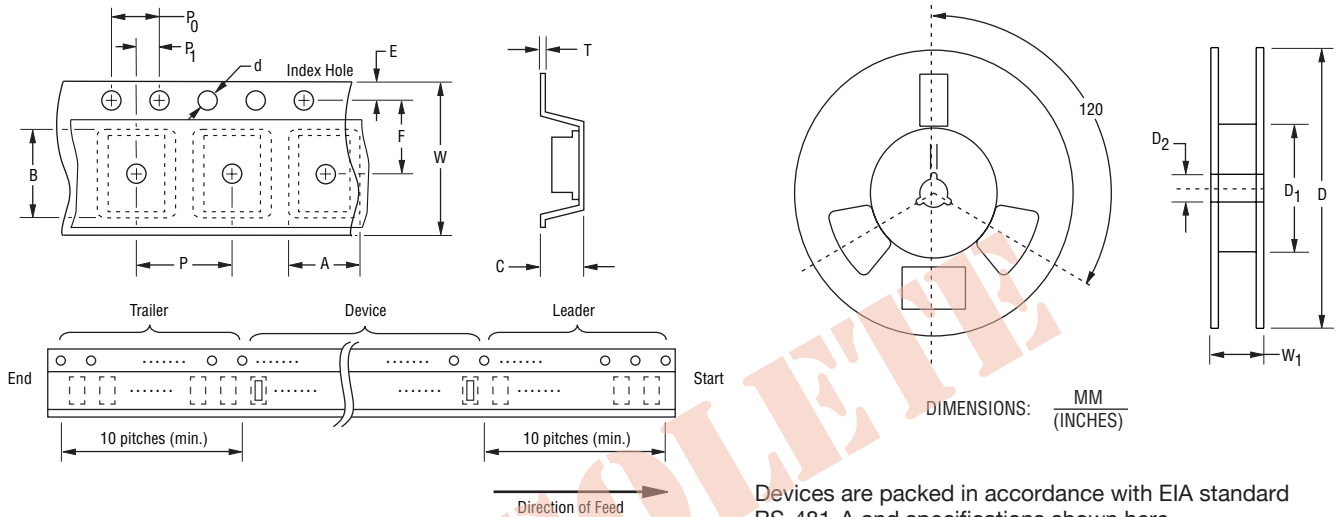

Item	Symbol	SMB (DO-214AA)
Carrier Width	A	$\frac{4.94 \pm 0.10}{(0.194 \pm 0.004)}$
Carrier Length	B	$\frac{5.57 \pm 0.10}{(0.219 \pm 0.004)}$
Carrier Depth	C	$\frac{2.36 \pm 0.10}{(0.093 \pm 0.004)}$
Sprocket Hole	d	$\frac{1.55 \pm 0.05}{(0.061 \pm 0.002)}$
Reel Outside Diameter	D	$\frac{330}{(12.992)}$
Reel Inner Diameter	D ₁	$\frac{50.0}{(1.969)}$ Min.
Feed Hole Diameter	D ₂	$\frac{13.0 \pm 0.20}{(0.512 \pm 0.008)}$
Sprocket Hole Position	E	$\frac{1.75 \pm 0.10}{(0.069 \pm 0.004)}$
Punch Hole Position	F	$\frac{5.50 \pm 0.05}{(0.217 \pm 0.002)}$
Punch Hole Pitch	P	$\frac{4.00 \pm 0.10}{(0.157 \pm 0.004)}$
Sprocket Hole Pitch	P ₀	$\frac{4.00 \pm 0.10}{(0.157 \pm 0.004)}$
Embossment Center	P ₁	$\frac{2.00 \pm 0.05}{(0.079 \pm 0.002)}$
Overall Tape Thickness	T	$\frac{0.30 \pm 0.10}{(0.012 \pm 0.004)}$
Tape Width	W	$\frac{12.00 \pm 0.20}{(0.472 \pm 0.008)}$
Reel Width	W ₁	$\frac{18.4}{(0.724)}$ Max.
Quantity per Reel	—	3,000

Specifications are subject to change without notice.

The device characteristics and parameters in this data sheet can and do vary in different applications and actual device performance may vary over time. Users should verify actual device performance in their specific applications.

CD214B-F350~F3600 Surface Mount Fast Response Rectifiers



Performance Graphs

Forward Current Derating Curve

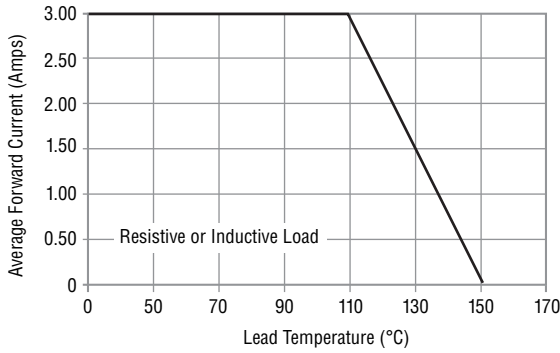

Maximum Non-Repetitive Surge Current

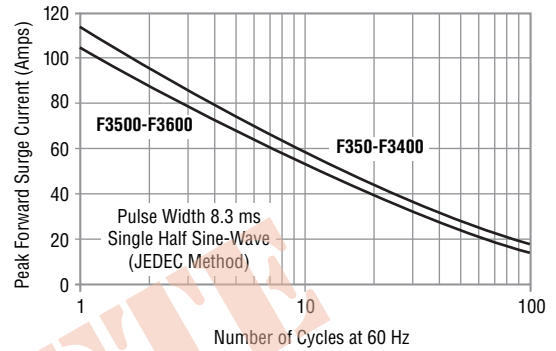

Typical Forward Characteristics

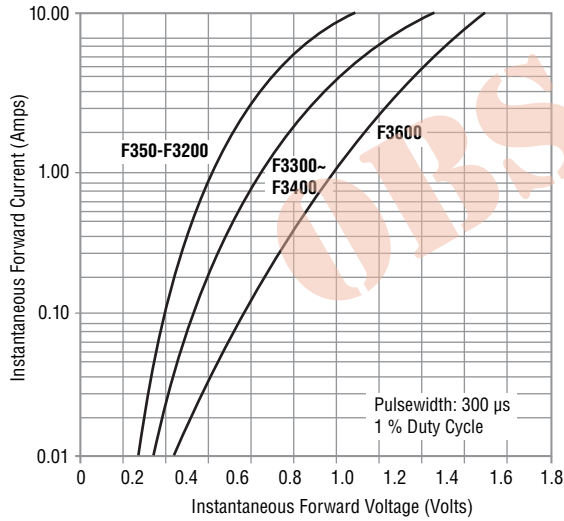

Typical Reverse Characteristics

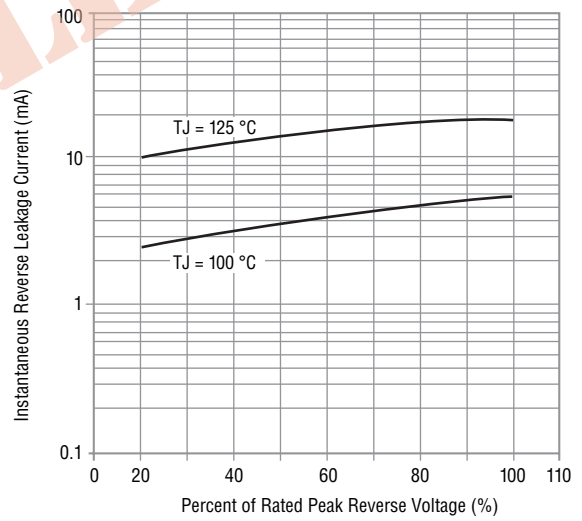

Typical Junction Capacitance

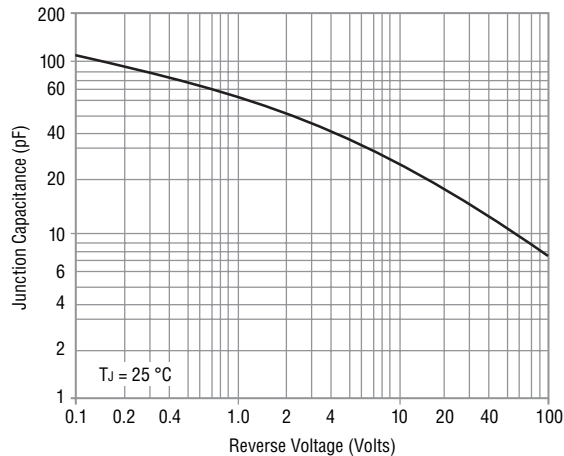

REV. 01/18

Specifications are subject to change without notice. The device characteristics and parameters in this data sheet can and do vary in different applications and actual device performance may vary over time. Users should verify actual device performance in their specific applications.