

FEATURES

Adjustable input threshold voltage options: 0.4 V and 1.23 V

Pretrimmed V_{CC} threshold options (ADM6306)

Increments between 2.5 V and 5 V

Manual reset input (ADM6306)

4 factory programmed reset timeout delays

1 ms, 20 ms, 140 ms, and 1.12 sec (minimum)

Reset output stage: active low, open drain

Low power consumption: 5 μ A typical

Power supply glitch immunity

5-lead SOT-23 package

Temperature range: -40°C to $+125^{\circ}\text{C}$

APPLICATIONS

Portable/battery operated equipment

Microprocessor systems

Multivoltage applications

GENERAL DESCRIPTION

The ADM6305/ADM6306 are dual voltage supervisors designed to monitor two supplies and provide a reset signal to DSP- and microprocessor-based systems. Low supply current and a small form factor make these devices suitable for portable and battery operated applications.

If a monitored power supply voltage falls below the minimum voltage threshold, a single active low output asserts triggering a system reset. After all voltages rise above the selected threshold level, the reset signal remains low for the reset timeout period. Four reset timeout options are available.

The ADM6305 monitors two supplies via two adjustable resistor-programmable undervoltage reset inputs. Both RST IN1 and RST IN2 have a reset threshold of either 0.4 V or 1.23 V depending on the particular model; that is, the RST IN1 and RST IN2 threshold of the ADM6305D3ARJZ-RL7 model is

FUNCTIONAL BLOCK DIAGRAMS

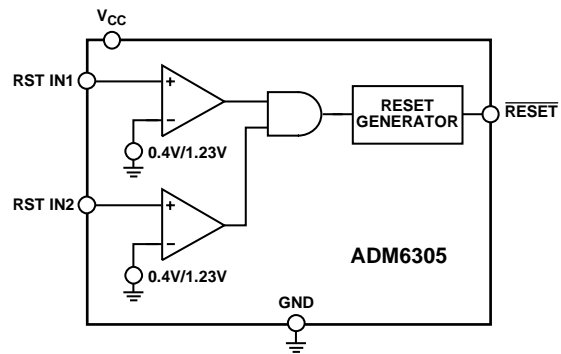

Figure 1.

09345-001

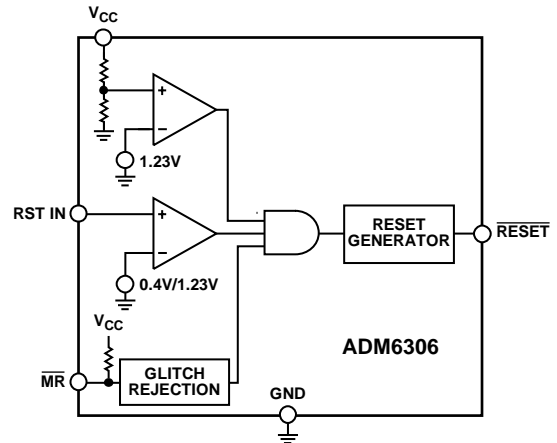

Figure 2.

09345-002

1.23 V, while in the case of ADM6305D3ARJZ1-RL7 model, it is 0.4 V. The V_{CC} input of the ADM6305 is not a monitored input.

The ADM6306 has one adjustable undervoltage reset input, RST IN, which features a choice of reset threshold, 0.4 V or 1.23 V (see the Ordering Guide for more information). The ADM6306 incorporates a variety of internally pretrimmed V_{CC} undervoltage threshold options for monitoring supply voltages in increments between 2.5 V and 5 V. The ADM6306 also includes a manual reset input. Not all options are released for sale as standard models. See the Ordering Guide for details.

The ADM6305/ADM6306 RESET output remains valid as long as V_{CC} exceeds 0.9 V.

The ADM6305/ADM6306 are available in a 5-lead SOT-23 package. These devices are specified over the temperature range of -40°C to $+125^{\circ}\text{C}$.

Rev. C

[Document Feedback](#)

Information furnished by Analog Devices is believed to be accurate and reliable. However, no responsibility is assumed by Analog Devices for its use, nor for any infringements of patents or other rights of third parties that may result from its use. Specifications subject to change without notice. No license is granted by implication or otherwise under any patent or patent rights of Analog Devices. Trademarks and registered trademarks are the property of their respective owners.

One Technology Way, P.O. Box 9106, Norwood, MA 02062-9106, U.S.A.
Tel: 781.329.4700 ©2010–2018 Analog Devices, Inc. All rights reserved.
[Technical Support](#) www.analog.com

TABLE OF CONTENTS

Features	1	Typical Performance Characteristics	7
Applications	1	Circuit Description	9
Functional Block Diagrams	1	Reset Output	9
General Description	1	Manual Reset Input	9
Revision History	2	Applications Information	10
Specifications	3	Negative Going V_{CC} Transients	10
Absolute Maximum Ratings	5	Ensuring Reset Valid to $V_{CC} = 0 V$	10
ESD Caution	5	Outline Dimensions	11
Pin Configuration and Function Descriptions	6	Ordering Guide	11

REVISION HISTORY

4/2018—Rev. D to Rev. E

Changes to General Description Section	1
Added Note 2, Table 1; Renumbered Sequentially	3
Changes to Ordering Guide	11

6/2016—Rev. C to Rev. D

Change to Table 3	6
Updated Outline Dimensions	11

4/2011—Rev. B to Rev. C

Updated Outline Dimensions	11
Changes to Ordering Guide	11

7/2008—Rev. A to Rev. B

Changes to Figure 5, Figure 8, and Figure 9	7
Changes to Figure 10	8
Changes to Figure 15	11
Changes to Ordering Guide	11

1/2007—Rev. 0 to Rev. A

Updated Format	Universal
Changes to Specifications Table	3
Updated Outline Dimensions	11
Changes to Ordering Guide	11

7/2005—Revision 0: Initial Version

SPECIFICATIONS

$V_{CC} = 2.5\text{ V}$ to 5 V for the [ADM6305](#), $V_{CC} = (V_{TH} + 2.5\%)$ to 5.5 V for the [ADM6306](#). $T_A = -40^\circ\text{C}$ to $+125^\circ\text{C}$, unless otherwise noted. Typical values are at $T_A = 25^\circ\text{C}$.

Table 1.

Parameter	Min	Typ	Max	Unit	Test Conditions/Comments
OPERATING VOLTAGE RANGE, V_{CC} ¹	0.9		5.5	V	V_{CC} that guarantees valid output
	0.9			V	
INPUT CURRENT, I_{CC}		5	16	μA	$V_{CC} = 5.5\text{ V}$, $T_A = -40^\circ\text{C}$ to $+85^\circ\text{C}$
		5	20	μA	$V_{CC} = 5.5\text{ V}$, $T_A = -40^\circ\text{C}$ to $+125^\circ\text{C}$
V_{CC} THRESHOLD VOLTAGE (ADM6306) ^{2,3}	$V_{TH} - 1\%$	V_{TH}	$V_{TH} + 1\%$	V	$T_A = 25^\circ\text{C}$
	$V_{TH} - 1.5\%$	V_{TH}	$V_{TH} + 1.5\%$	V	$T_A = -40^\circ\text{C}$ to $+85^\circ\text{C}$
	$V_{TH} - 2.5\%$	V_{TH}	$V_{TH} + 2.5\%$	V	$T_A = -40^\circ\text{C}$ to $+125^\circ\text{C}$
RESET THRESHOLD TEMPERATURE COEFFICIENT		25		ppm/ $^\circ\text{C}$	
RESET THRESHOLD HYSTERESIS (V_{HYST})		$2 \times V_{TH}$		mV	
RESET TIMEOUT PERIOD (t_{RP}) ³					
ADM630xD1	1.0	1.4	2.0	ms	
ADM630xD2	20	28	40	ms	
ADM630xD3	140	200	280	ms	
ADM630xD4	1120	1570	2240	ms	
RESET OUTPUT VOLTAGE (V_{OL})			0.4	V	$V_{CC} > 4.25\text{ V}$, $I_{SINK} = 3.2\text{ mA}$
			0.3	V	$V_{CC} > 2.5\text{ V}$, $I_{SINK} = 1.2\text{ mA}$
			0.3	V	$V_{CC} > 1.2\text{ V}$, $I_{SINK} = 500\ \mu\text{A}$
			0.3	V	$V_{CC} > 1\text{ V}$, $I_{SINK} = 50\ \mu\text{A}$
			0.3	V	$V_{CC} > 0.9\text{ V}$, $I_{SINK} = 25\ \mu\text{A}$
MR INPUT (ADM6306)					
V_{IL}			0.8	V	$V_{TH} > 4.0\text{ V}$
			$0.3 \times V_{CC}$	V	$V_{TH} < 4.0\text{ V}$
V_{IH}	2.4			V	$V_{TH} > 4.0\text{ V}$
	$0.7 \times V_{CC}$			V	$V_{TH} < 4.0\text{ V}$
MR Minimum Input Pulse Width	1			μs	$T_A = 0^\circ\text{C}$ to $+70^\circ\text{C}$
	1.5			μs	$T_A = -40^\circ\text{C}$ to $+125^\circ\text{C}$
MR Glitch Rejection		0.1		μs	
MR To Reset Delay		500		ns	
MR Pull-Up Resistance	32	63.5	100	k Ω	
1.23 V ADJUSTABLE RESET COMPARATOR INPUT					
RST INx Input Threshold, V_{RSTH}	1.22	1.23	1.24	V	$T_A = 25^\circ\text{C}$
	1.211	1.23	1.249		$T_A = -40^\circ\text{C}$ to $+85^\circ\text{C}$
	1.20		1.26	V	$T_A = -40^\circ\text{C}$ to $+125^\circ\text{C}$
RST INx Input Current, I_{RSTINx}	-25		+25	nA	$0\text{ V} < V_{RSTINx} < V_{CC} - 0.3\text{ V}$ ⁴ , $T_A = -40^\circ\text{C}$ to $+85^\circ\text{C}$
	-25		+25	nA	$V_{RSTIN} = V_{RSTH}$
RST INx Hysteresis		2.5		mV	
0.4 V ADJUSTABLE RESET COMPARATOR INPUT					
RST INx Input Threshold, V_{RSTH}	0.396	0.40	0.404	V	$T_A = 25^\circ\text{C}$
	0.394	0.40	0.406	V	$T_A = -40^\circ\text{C}$ to $+85^\circ\text{C}$
	0.39	0.40	0.41	V	$T_A = -40^\circ\text{C}$ to $+125^\circ\text{C}$
RST INx Input Current, I_{RSTINx}	-25		+25	nA	$0\text{ V} < V_{RSTINx} < V_{CC} - 0.3\text{ V}$ ⁴ , $T_A = -40^\circ\text{C}$ to $+85^\circ\text{C}$
	-25		+25	nA	$V_{RSTIN} = V_{RSTH}$

¹ The [ADM6305](#) switches from undervoltage reset to normal operation when $1.5\text{ V} > V_{CC} < 2.5\text{ V}$.

² The [ADM6306](#) monitors V_{CC} through an internal factory trimmed voltage divider, which programs the nominal reset threshold. Factory-trimmed reset thresholds are available in approximately 100 mV increments from 2.5 V to 5 V.

³ Not all options are released for sale as standard models. See the Ordering Guide for details.

⁴ Guaranteed by design.

ABSOLUTE MAXIMUM RATINGS

Table 2.

Parameter	Rating
V_{CC}	-0.3 V to +6 V
All Pins (Except V_{CC})	-0.3 V to ($V_{CC} + 0.3$ V)
Input/Output Current	20 mA
Rate of Rise, V_{CC}	100 V/ μ s
Storage Temperature Range	-65°C to +160°C
Operating Temperature Range	-40°C to +125°C
Lead Temperature (10 sec)	300°C
Junction Temperature	150°C

Stresses at or above those listed under Absolute Maximum Ratings may cause permanent damage to the product. This is a stress rating only; functional operation of the product at these or any other conditions above those indicated in the operational section of this specification is not implied. Operation beyond the maximum operating conditions for extended periods may affect product reliability.

THERMAL RESISTANCE

Table 3.

Package Type	θ_{JA}	Unit
5-Lead SOT-23	240	°C/W

ESD CAUTION



ESD (electrostatic discharge) sensitive device. Charged devices and circuit boards can discharge without detection. Although this product features patented or proprietary protection circuitry, damage may occur on devices subjected to high energy ESD. Therefore, proper ESD precautions should be taken to avoid performance degradation or loss of functionality.

PIN CONFIGURATIONS AND FUNCTION DESCRIPTIONS

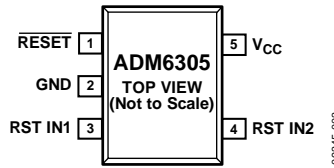

Figure 3. ADM6305 Pin Configuration

Table 4. ADM6305 Pin Function Descriptions

Pin No.	Mnemonic	Description
1	RESET	Active Low, Open-Drain $\overline{\text{RESET}}$ Output.
2	GND	Ground.
3	RST IN1	Adjustable Reset Comparator Input. This pin asserts $\overline{\text{RESET}}$ if the input voltage is below threshold. Its high input impedance allows the use of an external resistor divider to program the monitoring threshold. Connect this pin to the V_{CC} pin if it is not used.
4	RST IN2	Adjustable Reset Comparator Input. This pin asserts $\overline{\text{RESET}}$ if the input voltage is below threshold. Its high input impedance allows the use of an external resistor divider to program the monitoring threshold. Connect this pin to V_{CC} if it is not used.
5	V_{CC}	Power Supply Input. V_{CC} is not monitored on the ADM6305.

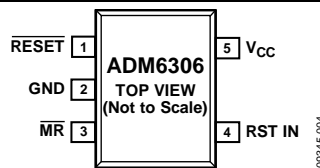

Figure 4. ADM6306 Pin Configuration

Table 5. ADM6306 Pin Function Descriptions

Pin No.	Mnemonic	Description
1	RESET	Active Low, Open-Drain $\overline{\text{RESET}}$ Output.
2	GND	Ground.
3	$\overline{\text{MR}}$	Manual Reset Input.
4	RST IN	Adjustable Reset Comparator Input. This pin asserts $\overline{\text{RESET}}$ if the input voltage is below threshold. Its high input impedance allows the use of an external resistor divider to program the monitoring threshold. Connect this pin to the V_{CC} pin if it is not used.
5	V_{CC}	Power Supply Input. V_{CC} is monitored on the ADM6306.

TYPICAL PERFORMANCE CHARACTERISTICS



Figure 5. Supply Current vs. Temperature

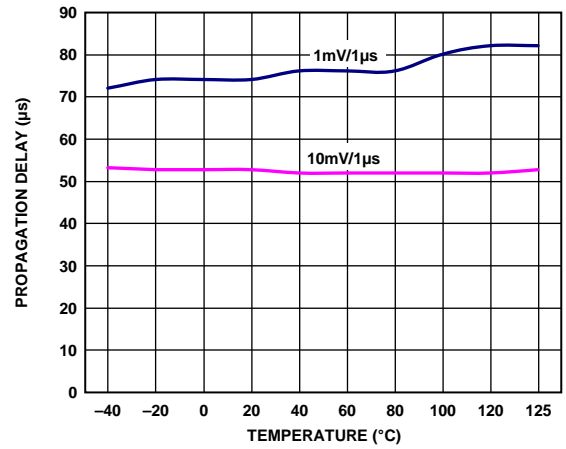

Figure 8. V_{CC} Falling Propagation Delay vs. Temperature

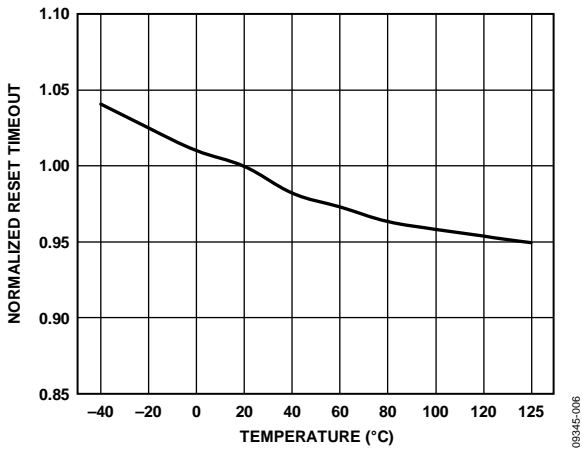

Figure 6. Reset Timeout vs. Temperature

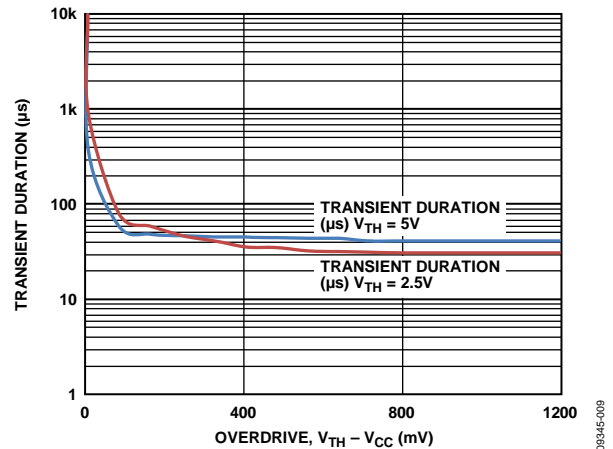

Figure 9. Maximum Transient Duration vs. V_{CC} Reset Threshold Overdrive

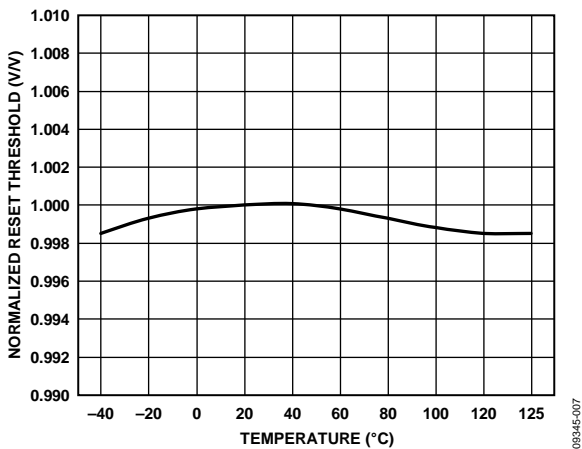

Figure 7. Reset Threshold vs. Temperature

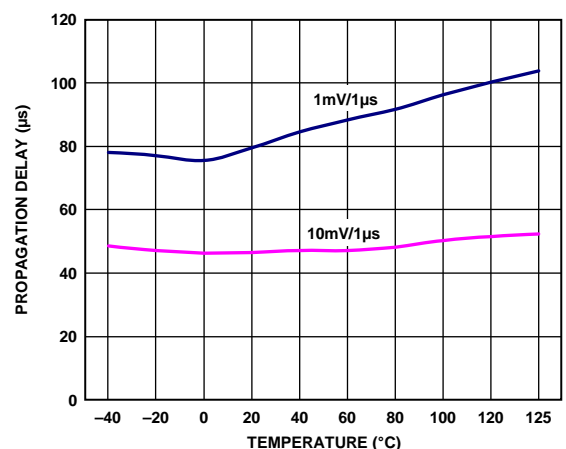

Figure 10. RST IN ($V_{TH} = 1.23\text{ V}$) Falling Propagation Delay vs. Temperature

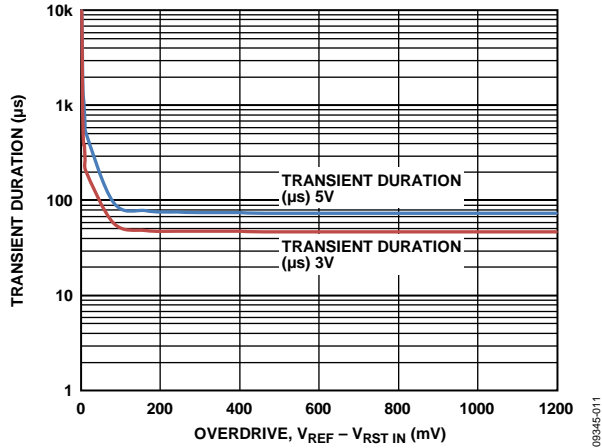

Figure 11. Maximum Transient Duration vs. RST IN ($V_{TH} = 1.23 V$) Threshold Overdrive

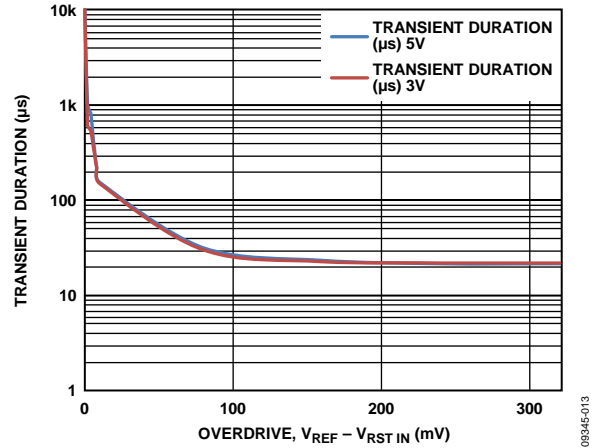

Figure 13. Maximum Transient Duration vs. RST INx ($V_{TH} = 0.4 V$) Threshold Overdrive



Figure 12. RST INx ($V_{TH} = 0.4 V$) Falling Propagation Delay vs. Temperature

THEORY OF OPERATION

The [ADM6305/ADM6306](#) are compact, low power supervisory circuits capable of monitoring two voltage rails. If a monitored voltage drops below its associated threshold, the active low reset output asserts low.

The [ADM6305](#) monitors two supplies via two adjustable resistor-programmable undervoltage reset inputs. Both RST IN1 and RST IN2 have a reset threshold of either 0.4 V or 1.23 V depending on the particular model; that is, the RST IN1 and RST IN2 threshold of the [ADM6305D3ARJZ-RL7](#) model is 1.23 V, while in the case of [ADM6305D3ARJZ1-RL7](#) model, it is 0.4 V. The V_{CC} input of the [ADM6305](#) is not a monitored input.

The [ADM6306](#) has one adjustable undervoltage reset input, RST IN, which features a choice of reset threshold, 0.4 V or 1.23 V (see the Ordering Guide for more information). The [ADM6306](#) incorporates a variety of internally pretrimmed V_{CC} undervoltage threshold options for monitoring supply voltages in increments between 2.5 V to 5 V. The [ADM6306](#) also includes a manual reset input.

INPUT CONFIGURATION

The threshold voltage at an adjustable input is either 0.4 V or 1.23 V. To monitor a voltage greater than the typical adjustable threshold, V_{RSTH} , connect a resistor divider network to the circuit as depicted in Figure 14, where

$$V_{TH} = V_{RSTH} \left(\frac{R1 + R2}{R2} \right)$$

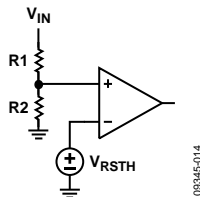

Figure 14. Setting the Adjustable Monitor

The high input impedance (leakage of ± 25 nA) of the adjustable inputs minimizes the offset error caused by the leakage current and external resistor divider. This allows the user to apply a divider with large resistance to minimize the loss. The offset voltage caused by the leakage current is calculated by $R1 \times \pm 25$ nA.

The RST INx inputs are designed to ignore fast voltage transients (see Figure 11 and Figure 12). Increase the noise immunity by connecting a 0.1 μ F bypass capacitor between RST INx and ground. Note that adding capacitance to RST INx slows the overall response time of the device.

There is no hysteresis associated with the 0.4 V adjustable inputs; instead, a time-based glitch filter to prevent false triggering is used. The glitch filter avoids the need to use a portion of the operating supply range to provide hysteresis

on this input. The [ADM6305/ADM6306](#) are powered via V_{CC} . Figure 9 shows the maximum transient duration vs. V_{CC} reset threshold overdrive, for which reset pulses are not generated. Figure 9 depicts the maximum pulse width that a negative going V_{CC} transient may typically have without causing RESET to be asserted. As the amplitude of the transient increases, the maximum allowable pulse width decreases. The addition of a bypass capacitor on V_{CC} provides additional transient immunity.

RESET OUTPUT CONFIGURATION

The [ADM6305/ADM6306](#) are available in a choice of four reset timeouts. After the monitored supplies rise above their associated threshold level, the RESET signal remains low for the reset timeout period before deasserting. Subsequently, if a monitored supply falls below its associated threshold, the RESET output reasserts. The open-drain RESET output of the [ADM6305/ADM6306](#) remains valid as long as V_{CC} exceeds 0.9 V.

The [ADM6305](#) remains in UVLO when V_{CC} is below 1.5 V. The RESET output is controlled by RTS INx if V_{CC} exceeds 2.5 V.

The open-drain RESET output allows the [ADM6305](#) and [ADM6306](#) to interface easily with microprocessors and devices with bidirectional reset pins. Connecting the supervisory devices RESET output directly to the microcontrollers RESET pin with a single pull-up resistor allows either device to issue a system reset (see Figure 15).

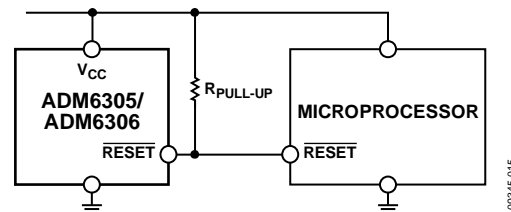

Figure 15. Interfacing to Microprocessors with Bidirectional RESET Output

MANUAL RESET

The [ADM6306](#) features a manual reset input (MR) which, when driven low, asserts the reset output. When MR transitions from low to high, reset remains asserted for the duration of the reset active timeout period before deasserting. The MR input has a 63.5 k Ω internal pull-up resistor so that the input is always high when unconnected. An external push-button switch can be connected between MR and ground so that the user can generate a reset. Debounce circuitry is integrated on-chip for this purpose. Noise immunity is provided on the MR input, and fast, negative going transients of up to 0.1 μ s (typical) are ignored. If required, a 0.1 μ F capacitor between MR and ground provides additional noise immunity.

DEVICE MODEL OPTIONS

The ADM6305/ADM6306 include many device options; however, not all options are released for sale. Released options are called standard models and are listed in the Ordering Guide. For the most up to date list of standard models, check the [Multi Voltage](#)

[Monitors](#) page on the Analog Devices website. Contact sales for information on nonstandard models and be aware that samples and production units have very long lead times.

Table 6. ADM6306 V_{CC} Reset Voltage Threshold Options

Reset Threshold Number	T _A = 25°C			T _A = -40°C to +125°C		Unit
	Min	Typ	Max	Min	Max	
25	2.463	2.5	2.538	2.438	2.563	V
26	2.591	2.63	2.669	2.564	2.696	V
27	2.66	2.7	2.741	2.633	2.768	V
28	2.758	2.8	2.842	2.73	2.87	V
29	2.886	2.93	2.974	2.857	3	V
30	2.955	3	3.045	2.925	3.075	V
31	3.034	3.08	3.126	3.003	3.157	V
32	3.152	3.2	3.248	3.12	3.28	V
33	3.251	3.3	3.35	3.218	3.383	V
34	3.349	3.4	3.451	3.315	3.485	V
35	3.448	3.5	3.553	3.413	3.588	V
36	3.546	3.6	3.654	3.51	3.69	V
37	3.645	3.7	3.756	3.608	3.793	V
38	3.743	3.8	3.857	3.705	3.895	V
39	3.842	3.9	3.959	3.803	3.998	V
40	3.94	4	4.06	3.9	4.1	V
41	4.039	4.1	4.162	3.998	4.203	V
42	4.137	4.2	4.263	4.095	4.305	V
43	4.236	4.3	4.365	4.193	4.408	V
44	4.314	4.38	4.446	4.27	4.49	V
45	4.433	4.5	4.568	4.388	4.613	V
46	4.561	4.63	4.699	4.514	4.746	V
47	4.63	4.7	4.771	4.583	4.818	V
48	4.728	4.8	4.872	4.68	4.92	V
49	4.827	4.9	4.974	4.778	5.023	V
50	4.925	5.0	5.075	4.875	5.125	V

Table 7. Reset Timeout Options

Reset Timeout Period Code	T _A = -40°C to +125°C			Unit
	Min	Typ	Max	
ADM630xD1	1.0	1.4	2.0	ms
ADM630xD2	20	28	40	ms
ADM630xD3	140	200	280	ms
ADM630xD4	1120	1570	2240	ms

Table 8. Adjustable Input Threshold Options

Model	Monitored Input Threshold		
	RST IN1	RST IN2	RST IN
ADM6305_____Z-RL7	1.23 V	1.23 V	N/A
ADM6305_____Z1-RL7	0.4 V	0.4 V	N/A
ADM6306_____Z-R7	N/A	N/A	1.23 V
ADM6306_____Z1-R7	N/A	N/A	0.4 V

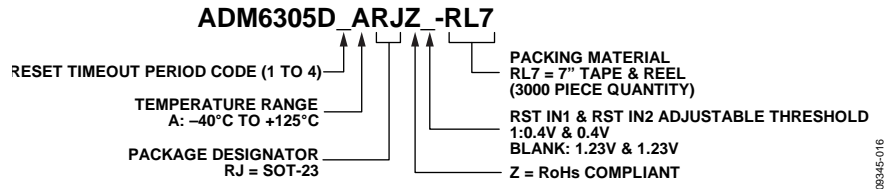

Figure 16. ADM6305 Ordering Code Structure

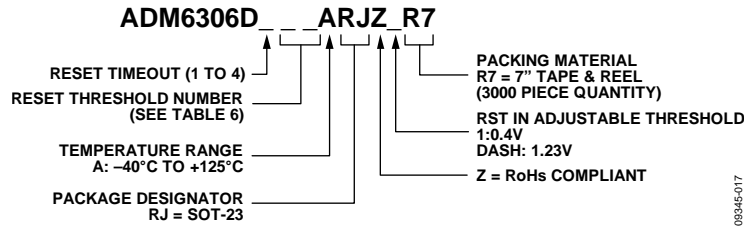

Figure 17. ADM6306 Ordering Code Structure

Table 9. Standard Models

Model	Monitored Input Threshold				Minimum Reset Timeout
	RST IN1	RST IN2	V _{cc} Reset	RST IN	
ADM6305D3ARJZ-RL7	1.23 V	1.23 V	N/A	N/A	140 ms
ADM6305D3ARJZ1-RL7	0.4 V	0.4 V	N/A	N/A	140 ms
ADM6306D131ARJZ-R7	N/A	N/A	3.08 V	1.23 V	1 ms
ADM6306D131ARJZ1R7	N/A	N/A	3.08 V	0.4 V	1 ms
ADM6306D329ARJZ-R7	N/A	N/A	2.93 V	1.23 V	140 ms
ADM6306D330ARJZ-R7	N/A	N/A	3 V	1.23 V	140 ms
ADM6306D331ARJZ-R7	N/A	N/A	3.08 V	1.23 V	140 ms
ADM6306D331ARJZ1R7	N/A	N/A	3.08 V	0.4 V	140 ms
ADM6306D344ARJZ-R7	N/A	N/A	4.38V	1.23 V	140 ms
ADM6306D346ARJZ-R7	N/A	N/A	4.63 V	1.23 V	140 ms

OUTLINE DIMENSIONS



COMPLIANT TO JEDEC STANDARDS MO-178-AA
 Figure 18. 5-Lead Small Outline Transistor Package [SOT-23] (RJ-5)
 Dimensions shown in millimeters

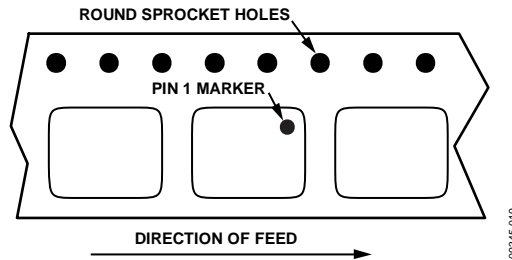

Figure 19. ADM6305/ADM6306 Reel Orientation

ORDERING GUIDE

Model ^{1, 2, 3}	Temperature Range	Ordering Quantity ⁴	Package Description	Package Option	Marking Code
ADM6305D3ARJZ-RL7	-40°C to +125°C	3,000	5-Lead SOT-23	RJ-5	LG9
ADM6305D3ARJZ1-RL7	-40°C to +125°C	3,000	5-Lead SOT-23	RJ-5	LG8
ADM6306D131ARJZ-R7	-40°C to +125°C	3,000	5-Lead SOT-23	RJ-5	LGA
ADM6306D131ARJZ1R7	-40°C to +125°C	3,000	5-Lead SOT-23	RJ-5	LGC
ADM6306D329ARJZ-R7	-40°C to +125°C	3,000	5-Lead SOT-23	RJ-5	LLY
ADM6306D330ARJZ-R7	-40°C to +125°C	3,000	5-Lead SOT-23	RJ-5	LM0
ADM6306D331ARJZ-R7	-40°C to +125°C	3,000	5-Lead SOT-23	RJ-5	LG6
ADM6306D331ARJZ1R7	-40°C to +125°C	3,000	5-Lead SOT-23	RJ-5	LQC
ADM6306D344ARJZ-R7	-40°C to +125°C	3,000	5-Lead SOT-23	RJ-5	LM1
ADM6306D346ARJZ-R7	-40°C to +125°C	3,000	5-Lead SOT-23	RJ-5	LLZ

¹ ADM6305 and ADM6306 follow the C2 Pin 1 orientation standard for tape and reel packaging (see Figure 19).
² The ADM6305/ADM6306 include many device options, however, not all options are released for sale. Released options are called standard models and are listed in the Ordering Guide. For the most up to date list of standard models, check the [Multi Voltage Monitors](#) page on the Analog Devices website. Contact sales for information on nonstandard models and be aware that samples and production units have very long lead times.
³ Z = RoHS Compliant Part.
⁴ If ordering nonstandard models, complete the ordering code shown in Figure 16 and Figure 17 by inserting the reset threshold, reset timeout, and adjustable threshold suffixes.

NOTES