

FEATURES

Supply range

2.8 V to 15 V, ADR291

4.4 V to 15 V, ADR292

Supply current: 15 μ A maximum

Low noise: 8 μ V and 12 μ V p-p (0.1 Hz to 10 Hz)

High output current: 5 mA

Temperature range: -40°C to $+125^{\circ}\text{C}$

Pin-compatible with REF02/REF19x

APPLICATIONS

Portable instrumentation

Precision reference for 3 V and 5 V systems

Analog-to-digital and digital-to-analog converter reference

Solar-powered applications

Loop-current-powered instruments

GENERAL DESCRIPTION

The ADR291 and ADR292 are low noise, micropower precision voltage references that use an XFET[®] reference circuit. The new XFET architecture offers significant performance improvements over traditional band gap and buried Zener-based references. Improvements include one quarter the voltage noise output of band gap references operating at the same current, very low and ultralinear temperature drift, low thermal hysteresis, and excellent long-term stability.

The ADR291/ADR292 family is a series of voltage references providing stable and accurate output voltages from supplies as low as 2.8 V for the ADR291. Output voltage options are 2.5 V and 4.096 V for the ADR291 and ADR292, respectively.

Quiescent current is only 12 μ A, making these devices ideal for battery-powered instrumentation. Three electrical grades are available offering initial output accuracies of ± 2 mV, ± 3 mV, and ± 6 mV maximum for the ADR291, and ± 3 mV, ± 4 mV, and ± 6 mV maximum for the ADR292. Temperature

coefficients for the three grades are 8 ppm/ $^{\circ}\text{C}$, 15 ppm/ $^{\circ}\text{C}$, and 25 ppm/ $^{\circ}\text{C}$ maximum, respectively. Line regulation and load regulation are typically 30 ppm/V and 30 ppm/mA, maintaining the reference's overall high performance. For a device with 5.0 V output, refer to the ADR293 data sheet.

The ADR291 and ADR292 references are specified over the extended industrial temperature range of -40°C to $+125^{\circ}\text{C}$. Devices are available in the 8-lead SOIC, 8-lead TSSOP, and 3-lead TO-92 packages.

Table 1. ADR291/ADR292 Product

Part No.	Output Voltage (V)	Initial Accuracy ($\pm\%$)	Temperature Coefficient (ppm/ $^{\circ}\text{C}$) Max
ADR291	2.500	0.08, 0.12, 0.24	8, 15, 25
ADR292	4.096	0.07, 0.10, 0.15	8, 15, 25

CONNECTION DIAGRAMS

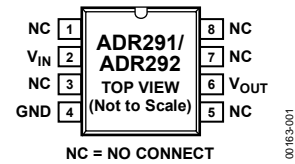

Figure 1. 8-Lead SOIC (R-8)

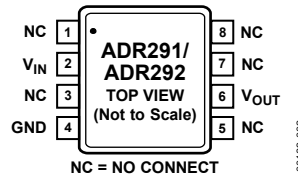

Figure 2. 8-Lead TSSOP (RU-8)

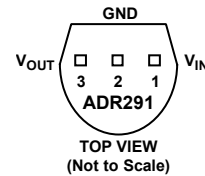

Figure 3. 3-Lead TO-92 (T-3)

Rev. E

Information furnished by Analog Devices is believed to be accurate and reliable. However, no responsibility is assumed by Analog Devices for its use, nor for any infringements of patents or other rights of third parties that may result from its use. Specifications subject to change without notice. No license is granted by implication or otherwise under any patent or patent rights of Analog Devices. Trademarks and registered trademarks are the property of their respective owners.

TABLE OF CONTENTS

Features	1	Device Power Dissipation Considerations.....	13
Applications.....	1	Basic Voltage Reference Connections	13
Connection Diagrams.....	1	Noise Performance	13
General Description	1	Turn-On Time	13
Revision History	2	Applications Information	14
Specifications.....	3	Negative Precision Reference Without Precision Resistors..	14
ADR291 Electrical Specifications.....	3	Precision Current Source	14
ADR292 Electrical Specifications.....	4	High Voltage Floating Current Source	14
Absolute Maximum Ratings.....	6	Kelvin Connections.....	15
ESD Caution.....	6	Low Power, Low Voltage Reference for Data Converters	15
Pin Configurations and Function Descriptions	7	Voltage Regulator for Portable Equipment.....	15
Typical Performance Characteristics	8	Outline Dimensions	16
Terminology	12	Ordering Guide	17
Theory of Operation	13		

REVISION HISTORY

12/07—Rev. D to Rev. E

Changes to Features.....	1
Changes to Figure 34.....	14

3/06—Rev. C to Rev. D

Updated Format.....	Universal
Change to Table 8	6
Updated Outline Dimensions	15
Changes to Ordering Guide	16

9/03—Rev. B to Rev. C

Deleted ADR290.....	Universal
Changes to Specifications.....	2
Changes to Ordering Guide	4
Updated Outline Dimensions	13

SPECIFICATIONS

ADR291 ELECTRICAL SPECIFICATIONS

$V_S = 3.0\text{ V to }15\text{ V}$, $T_A = 25^\circ\text{C}$, unless otherwise noted.

Table 2.

Parameter	Symbol	Conditions	Min	Typ	Max	Unit
E GRADE						
Output Voltage	V_{OUT}	$I_{OUT} = 0\text{ mA}$	2.498	2.500	2.502	V
Initial Accuracy	V_{OERR}		-2		+2	mV
			-0.08		+0.08	%
F GRADE						
Output Voltage	V_{OUT}	$I_{OUT} = 0\text{ mA}$	2.497	2.500	2.503	V
Initial Accuracy	V_{OERR}		-3		+3	mV
			-0.12		+0.12	%
G GRADE						
Output Voltage	V_{OUT}	$I_{OUT} = 0\text{ mA}$	2.494	2.500	2.506	V
Initial Accuracy	V_{OERR}		-6		+6	mV
			-0.24		+0.24	%
LINE REGULATION						
E/F Grades	$\Delta V_{OUT}/\Delta V_{IN}$	$I_{OUT} = 0\text{ mA}$		30	100	ppm/V
G Grade				40	125	ppm/V
LOAD REGULATION						
E/F Grades	$\Delta V_{OUT}/\Delta I_{LOAD}$	$V_S = 5.0\text{ V}$, $I_{OUT} = 0\text{ mA to }5\text{ mA}$		30	100	ppm/mA
G Grade				40	125	ppm/mA
LONG-TERM STABILITY	ΔV_{OUT}	After 1000 hours of operation @ 125°C		50		ppm
NOISE VOLTAGE	e_N	0.1 Hz to 10 Hz		8		$\mu\text{V p-p}$
WIDEBAND NOISE DENSITY	e_N	@ 1 kHz		480		$\text{nV}/\sqrt{\text{Hz}}$

$V_S = 3.0\text{ V to }15\text{ V}$, $T_A = -25^\circ\text{C to }+85^\circ\text{C}$, unless otherwise noted.

Table 3.

Parameter	Symbol	Conditions	Min	Typ	Max	Unit
TEMPERATURE COEFFICIENT						
E Grade	TCV_{OUT}	$I_{OUT} = 0\text{ mA}$		3	8	ppm/ $^\circ\text{C}$
F Grade				5	15	ppm/ $^\circ\text{C}$
G Grade				10	25	ppm/ $^\circ\text{C}$
LINE REGULATION						
E/F Grades	$\Delta V_{OUT}/\Delta V_{IN}$	$I_{OUT} = 0\text{ mA}$		35	125	ppm/V
G Grade				50	150	ppm/V
LOAD REGULATION						
E/F Grades	$\Delta V_{OUT}/\Delta I_{LOAD}$	$V_S = 5.0\text{ V}$, $I_{OUT} = 0\text{ mA to }5\text{ mA}$		20	125	ppm/mA
G Grade				30	150	ppm/mA

ADR291/ADR292

$V_S = 3.0\text{ V to }15\text{ V}$, $T_A = -40^\circ\text{C to }+125^\circ\text{C}$, unless otherwise noted.

Table 4.

Parameter	Symbol	Conditions	Min	Typ	Max	Unit
TEMPERATURE COEFFICIENT						
E Grade	TCV_{OUT}	$I_{OUT} = 0\text{ mA}$		3	10	ppm/°C
F Grade				5	20	ppm/°C
G Grade				10	30	ppm/°C
LINE REGULATION						
E/F Grades	$\Delta V_{OUT}/\Delta V_{IN}$	$I_{OUT} = 0\text{ mA}$		40	200	ppm/V
G Grade				70	250	ppm/V
LOAD REGULATION						
E/F Grades	$\Delta V_{OUT}/\Delta I_{LOAD}$	$V_S = 5.0\text{ V}$, $I_{OUT} = 0\text{ mA to }5\text{ mA}$		20	200	ppm/mA
G Grade				30	300	ppm/mA
SUPPLY CURRENT	I_S	$T_A = 25^\circ\text{C}$ $-40^\circ\text{C} \leq T_A \leq +125^\circ\text{C}$		9	12	μA
				12	15	μA
THERMAL HYSTERESIS	$V_{OUT-HYS}$	8-lead SOIC, 8-lead TSSOP		50		ppm

ADR292 ELECTRICAL SPECIFICATIONS

$V_S = 5\text{ V to }15\text{ V}$, $T_A = 25^\circ\text{C}$, unless otherwise noted.

Table 5.

Parameter	Symbol	Conditions	Min	Typ	Max	Unit
E GRADE						
Output Voltage	V_{OUT}	$I_{OUT} = 0\text{ mA}$	4.093	4.096	4.099	V
Initial Accuracy	V_{OERR}		-3		+3	mV
			-0.07		+0.07	%
F GRADE						
Output Voltage	V_{OUT}	$I_{OUT} = 0\text{ mA}$	4.092	4.096	4.1	V
Initial Accuracy	V_{OERR}		-4		+4	mV
			-0.10		+0.10	%
G GRADE						
Output Voltage	V_{OUT}	$I_{OUT} = 0\text{ mA}$	4.090	4.096	4.102	V
Initial Accuracy	V_{OERR}		-6		+6	mV
			-0.15		+0.15	%
LINE REGULATION						
E/F Grades	$\Delta V_{OUT}/\Delta V_{IN}$	$V_S = 4.5\text{ V to }15\text{ V}$, $I_{OUT} = 0\text{ mA}$		30	100	ppm/V
G Grade				40	125	ppm/V
LOAD REGULATION						
E/F Grades	$\Delta V_{OUT}/\Delta I_{LOAD}$	$V_S = 5.0\text{ V}$, $I_{OUT} = 0\text{ mA to }5\text{ mA}$		30	100	ppm/mA
G Grade				40	125	ppm/mA
LONG-TERM STABILITY	ΔV_{OUT}	After 1000 hours of operation @ 125°C		50		ppm
NOISE VOLTAGE	e_N	0.1 Hz to 10 Hz		12		$\mu\text{V p-p}$
WIDEBAND NOISE DENSITY	e_N	@ 1 kHz		640		$\text{nV}/\sqrt{\text{Hz}}$

$V_S = 5\text{ V to }15\text{ V}$, $T_A = -25^\circ\text{C to }+85^\circ\text{C}$, unless otherwise noted.

Table 6.

Parameter	Symbol	Conditions	Min	Typ	Max	Unit
TEMPERATURE COEFFICIENT						
E Grade	TCV _{OUT}	I _{OUT} = 0 mA		3	8	ppm/°C
F Grade				5	15	ppm/°C
G Grade				10	25	ppm/°C
LINE REGULATION						
E/F Grades	$\Delta V_{OUT}/\Delta V_{IN}$	$V_S = 4.5\text{ V to }15\text{ V}$, I _{OUT} = 0 mA		35	125	ppm/V
G Grade				50	150	ppm/V
LOAD REGULATION						
E/F Grades	$\Delta V_{OUT}/\Delta I_{LOAD}$	$V_S = 5.0\text{ V}$, I _{OUT} = 0 mA to 5 mA		20	125	ppm/mA
G Grade				30	150	ppm/mA

$V_S = 5\text{ V to }15\text{ V}$, $T_A = -40^\circ\text{C to }+125^\circ\text{C}$, unless otherwise noted.

Table 7.

Parameter	Symbol	Conditions	Min	Typ	Max	Unit
TEMPERATURE COEFFICIENT						
E Grade	TCV _{OUT}	I _{OUT} = 0 mA		3	10	ppm/°C
F Grade				5	20	ppm/°C
G Grade				10	30	ppm/°C
LINE REGULATION						
E/F Grades	$\Delta V_{OUT}/\Delta V_{IN}$	$V_S = 4.5\text{ V to }15\text{ V}$, I _{OUT} = 0 mA		40	200	ppm/V
G Grade				70	250	ppm/V
LOAD REGULATION						
E/F Grades	$\Delta V_{OUT}/\Delta I_{LOAD}$	$V_S = 5.0\text{ V}$, I _{OUT} = 0 mA to 5 mA		20	200	ppm/mA
G Grade				30	300	ppm/mA
SUPPLY CURRENT	I _S	T _A = 25°C		10	15	μA
		-40°C ≤ T _A ≤ +125°C		12	18	μA
THERMAL HYSTERESIS	V _{OUT-HYS}	8-lead SOIC, 8-lead TSSOP		50		ppm

ABSOLUTE MAXIMUM RATINGS

Remove power before inserting or removing units from their sockets.

Table 8.

Parameter	Rating
Supply Voltage	18 V
Output Short-Circuit Duration to GND	Indefinite
Storage Temperature Range T, R, RU Packages	-65°C to +150°C
Operating Temperature Range ADR291/ADR292	-40°C to +125°C
Junction Temperature Range T, R, RU Packages	-65°C to +125°C
Lead Temperature (Soldering, 60 sec)	300°C

Stresses above those listed under Absolute Maximum Ratings may cause permanent damage to the device. This is a stress rating only; functional operation of the device at these or any other conditions above those indicated in the operational section of this specification is not implied. Exposure to absolute maximum rating conditions for extended periods may affect device reliability.

Table 9. Package Types

Package Type	θ_{JA}^1	θ_{JC}	Unit
8-Lead SOIC (R)	158	43	°C/W
8-Lead TSSOP (RU)	240	43	°C/W
3-Lead TO-92 (T)	160	-	°C/W

¹ θ_{JA} is specified for worst-case conditions. For example, θ_{JA} is specified for a device in socket testing. In practice, θ_{JA} is specified for a device soldered in the circuit board.

Table 10. Other XFET Products

Part Number	Nominal Output Voltage (V)	Package Type
ADR420	2.048	8-Lead MSOP/SOIC
ADR421	2.50	8-Lead MSOP/SOIC
ADR423	3.0	8-Lead MSOP/SOIC
ADR425	5.0	8-Lead MSOP/SOIC

ESD CAUTION



ESD (electrostatic discharge) sensitive device.

Charged devices and circuit boards can discharge without detection. Although this product features patented or proprietary protection circuitry, damage may occur on devices subjected to high energy ESD. Therefore, proper ESD precautions should be taken to avoid performance degradation or loss of functionality.

PIN CONFIGURATIONS AND FUNCTION DESCRIPTIONS

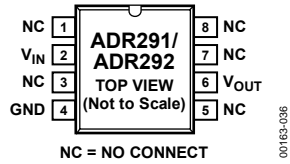

Figure 4. 8-Lead SOIC (R-8)

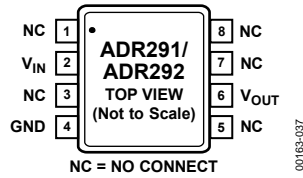

Figure 5. 8-Lead TSSOP (RU-8)

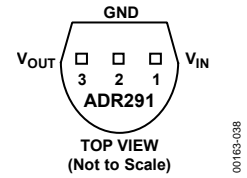

Figure 6. 3-Lead TO-92 (T-3)

Table 11. Pin Function Descriptions

Pin No.			Mnemonic	Description
SOIC	TSSOP	TO-92		
1, 3, 5, 7, 8	1, 3, 5, 7, 8	N/A	NC	No Connect
2	2	1	V _{IN}	Input Voltage
4	4	2	GND	Ground
6	6	3	V _{OUT}	Output Voltage

TYPICAL PERFORMANCE CHARACTERISTICS

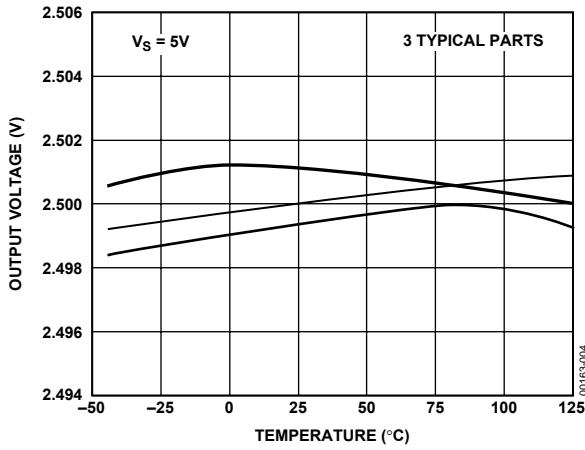

Figure 7. ADR291 V_{OUT} vs. Temperature

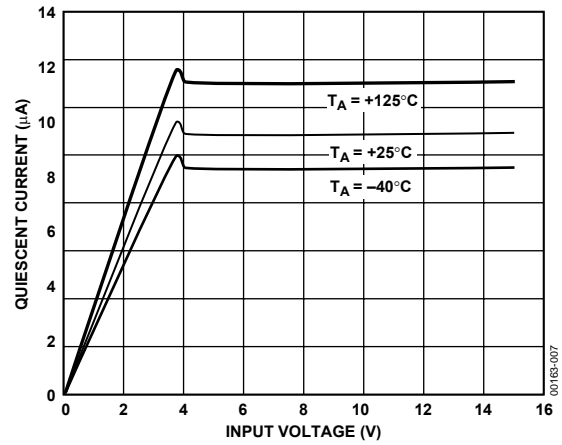

Figure 10. ADR292 Quiescent Current vs. Input Voltage

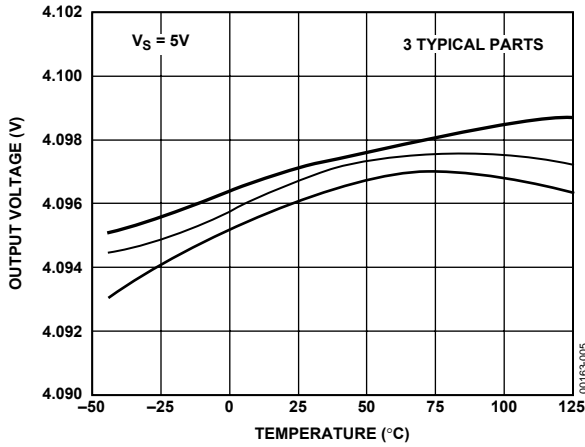

Figure 8. ADR292 V_{OUT} vs. Temperature

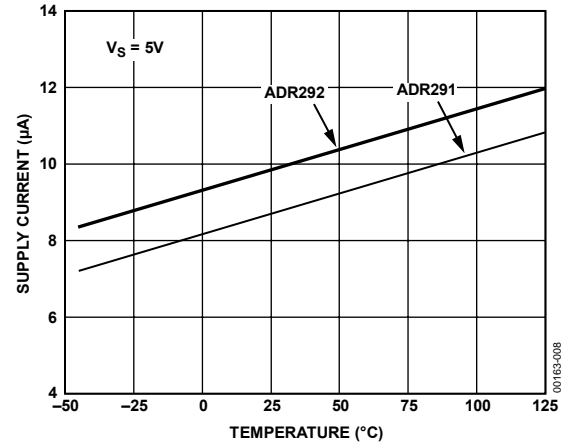

Figure 11. ADR291/ADR292 Supply Current vs. Temperature

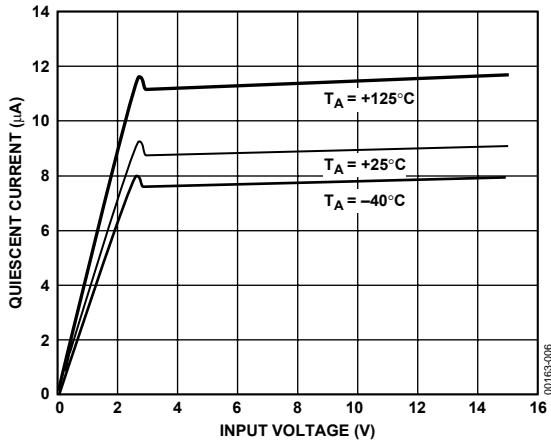

Figure 9. ADR291 Quiescent Current vs. Input Voltage

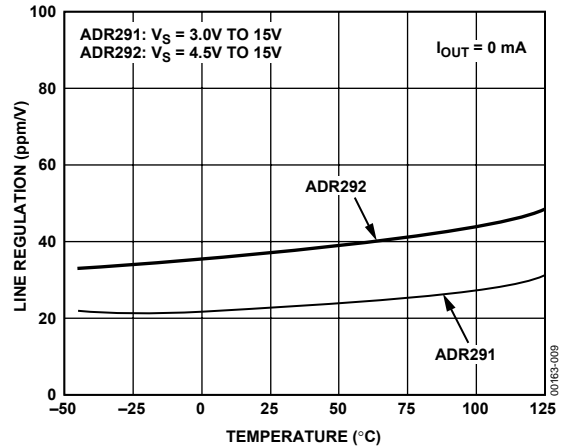

Figure 12. ADR291/ADR292 Line Regulation vs. Temperature

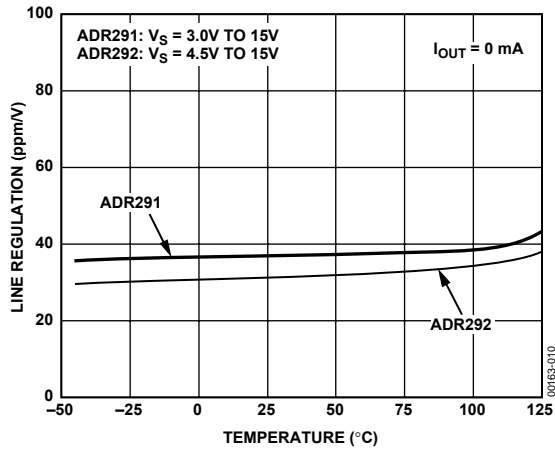

Figure 13. ADR291/ADR292 Line Regulation vs. Temperature

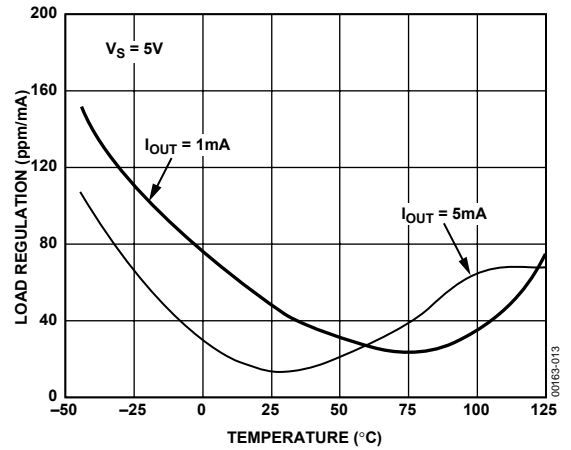

Figure 16. ADR291 Load Regulation vs. Temperature

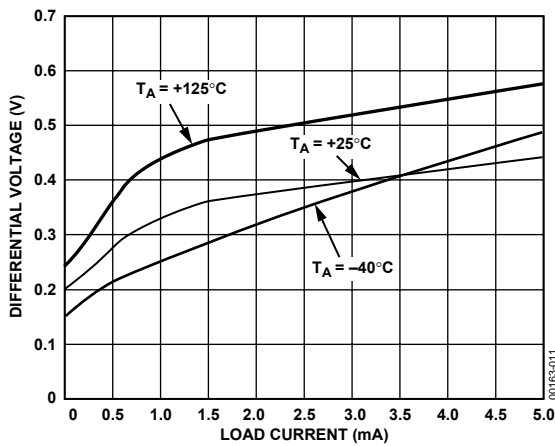

Figure 14. ADR291 Minimum Input-Output Voltage Differential vs. Load Current

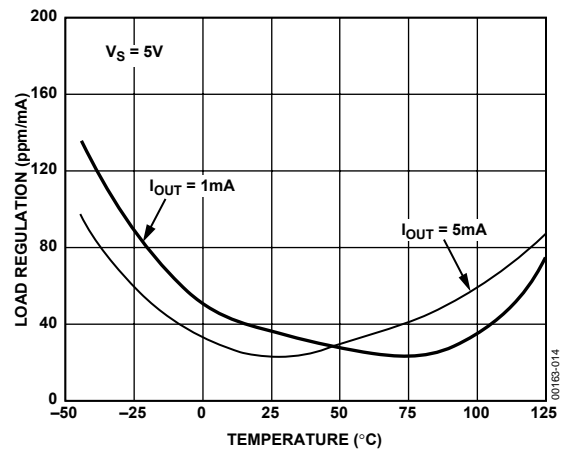

Figure 17. ADR292 Load Regulation vs. Temperature

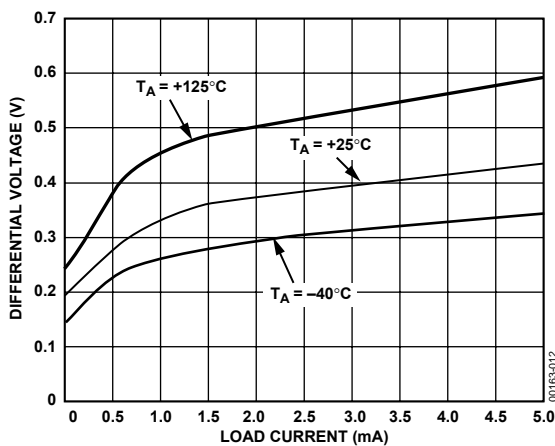

Figure 15. ADR292 Minimum Input-Output Voltage Differential vs. Load Current

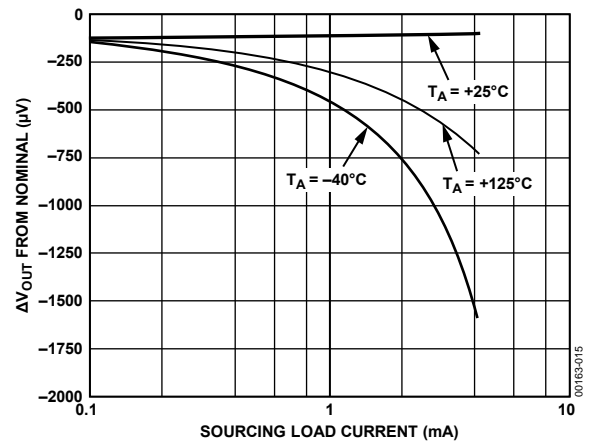

Figure 18. ADR291 ΔV_{OUT} from Nominal vs. Load Current

ADR291/ADR292

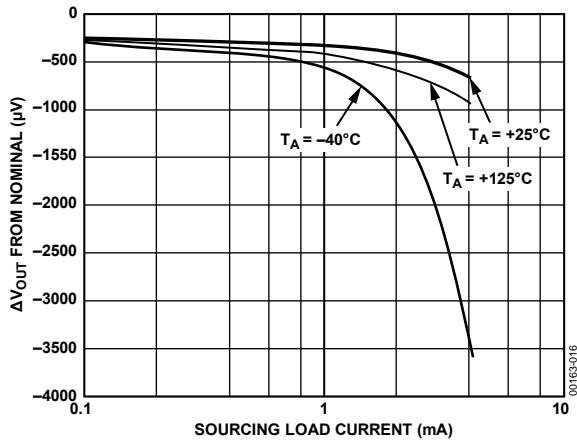

Figure 19. ADR292 ΔV_{OUT} from Nominal vs. Load Current

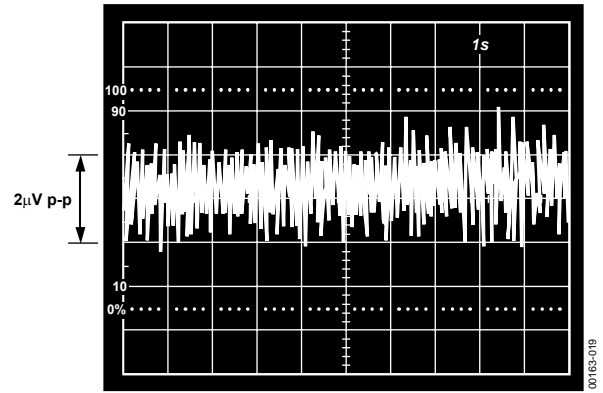

Figure 22. ADR291 0.1 Hz to 10 Hz Noise

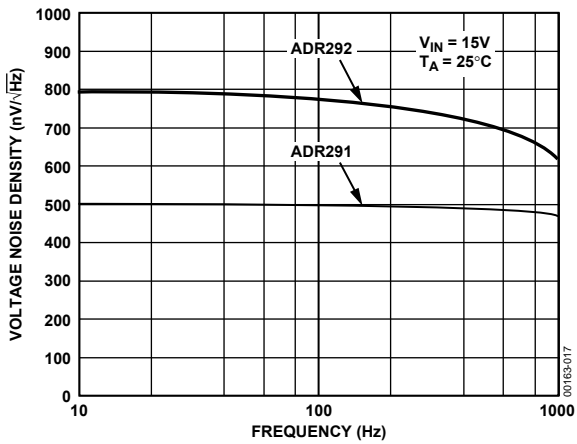

Figure 20. Voltage Noise Density vs. Frequency

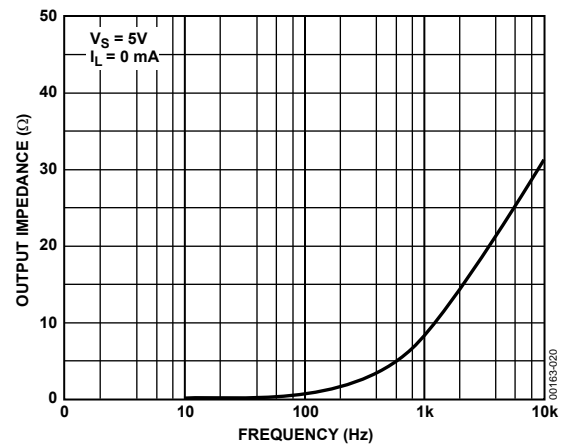

Figure 23. ADR291 Output Impedance vs. Frequency

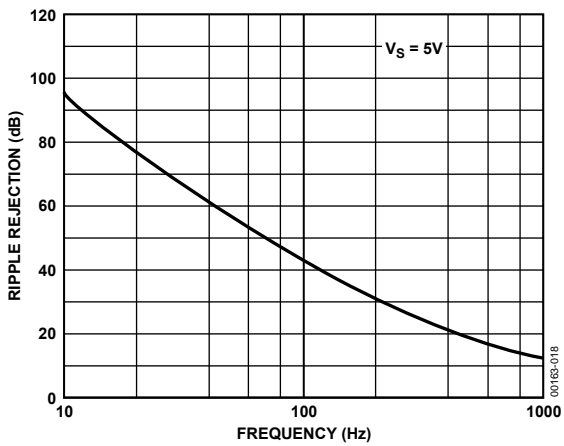

Figure 21. ADR291/ADR292 Ripple Rejection vs. Frequency

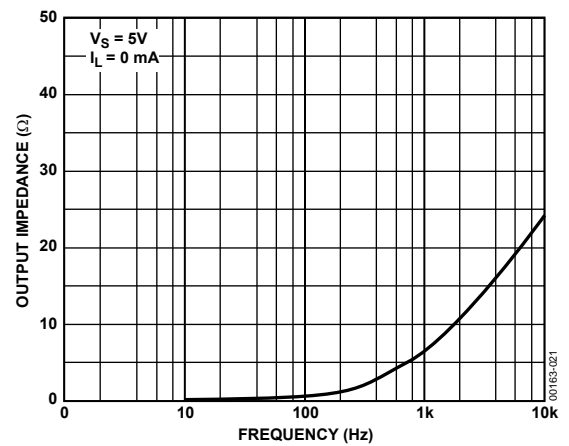

Figure 24. ADR292 Output Impedance vs. Frequency

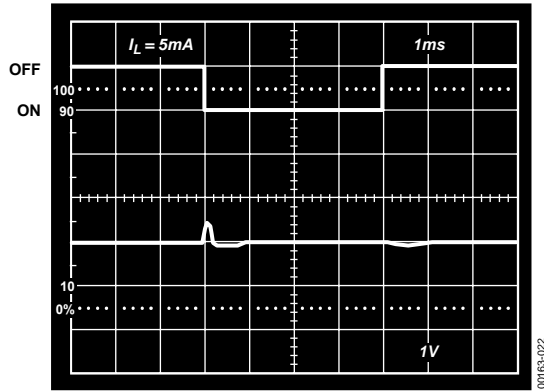

Figure 25. ADR291 Load Transient

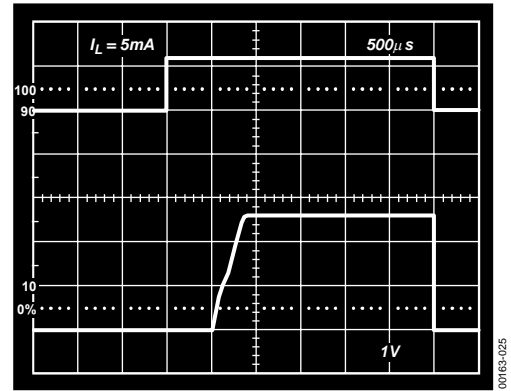

Figure 28. ADR291 Turn-On Time

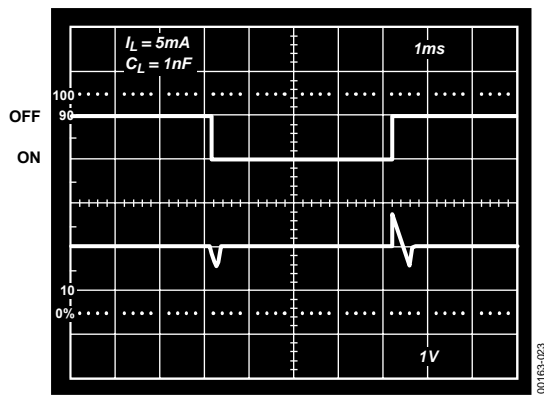

Figure 26. ADR291 Load Transient

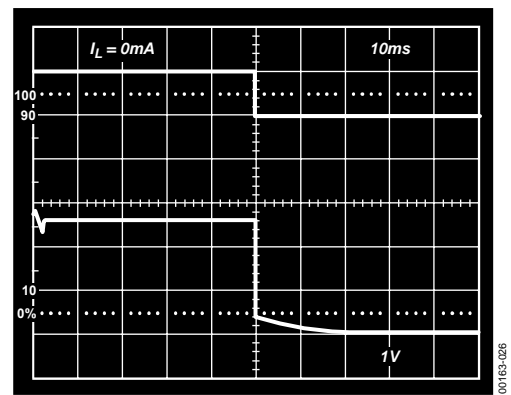

Figure 29. ADR291 Turn-Off Time

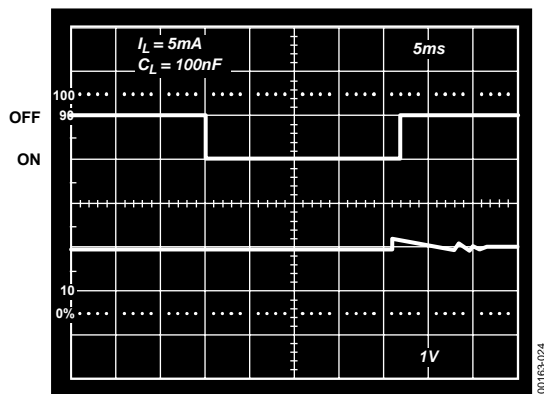

Figure 27. ADR291 Load Transient

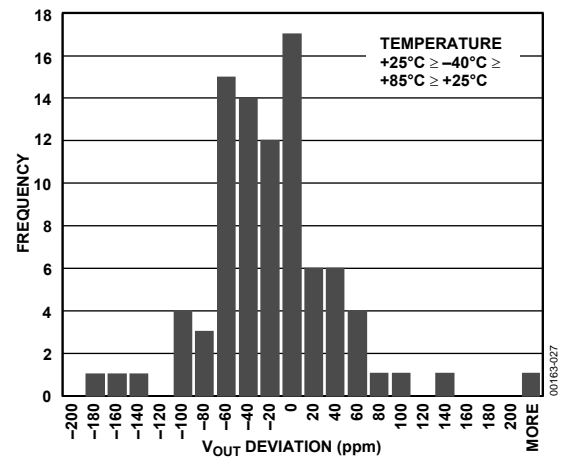

Figure 30. Typical Hysteresis for the ADR291 Product

TERMINOLOGY

Line Regulation

Line regulation refers to the change in output voltage due to a specified change in input voltage. It includes the effects of self-heating. Line regulation is expressed as percent-per-volt, parts-per-million-per-volt, or microvolts-per-volt change in input voltage.

Load Regulation

The change in output voltage is due to a specified change in load current and includes the effects of self-heating. Load regulation is expressed in microvolts-per-milliampere, parts-per-million-per-milliampere, or ohms of dc output resistance.

Long-Term Stability

Long-term stability refers to the typical shift of output voltage at 25°C on a sample of parts subjected to a test of 1000 hours at 125°C.

$$\Delta V_{OUT} = V_{OUT}(t_0) - V_{OUT}(t_1)$$

$$\Delta V_{OUT} [\text{ppm}] = \frac{V_{OUT}(t_0) - V_{OUT}(t_1)}{V_{OUT}(t_0)} \times 10^6$$

where:

$V_{OUT}(t_0)$ = V_{OUT} at 25°C at Time 0.

$V_{OUT}(t_1)$ = V_{OUT} at 25°C after 1000 hours of operation at 125°C.

Temperature Coefficient

Temperature coefficient is the change of output voltage over the operating temperature change, normalized by the output voltage at 25°C, expressed in ppm/°C. The equation follows:

$$TCV_o [\text{ppm}/^\circ\text{C}] = \frac{V_o(T_2) - V_o(T_1)}{V_o(25^\circ\text{C}) \times (T_2 - T_1)} \times 10^6$$

where:

$V_{OUT}(25^\circ\text{C})$ = V_{OUT} at 25°C.

$V_{OUT}(T_1)$ = V_{OUT} at Temperature 1.

$V_{OUT}(T_2)$ = V_{OUT} at Temperature 2.

NC = no connect.

There are internal connections at NC pins that are reserved for manufacturing purposes. Users should not connect anything at the NC pins.

Thermal Hysteresis

Thermal hysteresis is defined as the change of output voltage after the device is cycled through temperatures from +25°C to -40°C, then to +85°C, and back to +25°C. This is a typical value from a sample of parts put through such a cycle.

$$V_{OUT-HYS} = V_{OUT}(25^\circ\text{C}) - V_{OUT_TC}$$

$$V_{OUT-HYS} [\text{ppm}] = \frac{V_{OUT}(25^\circ\text{C}) - V_{OUT_TC}}{V_{OUT}(25^\circ\text{C})} \times 10^6$$

where:

$V_{OUT}(25^\circ\text{C})$ = V_{OUT} at 25°C.

V_{OUT_TC} = V_{OUT} at 25°C after temperature cycle from +25°C to -40°C, then to +85°C, and back to +25°C.

THEORY OF OPERATION

The ADR291/ADR292 series of references uses a reference generation technique known as XFET (eXtra implanted junction FET). This technique yields a reference with low noise, low supply current, and very low thermal hysteresis.

The core of the XFET reference consists of two junction field effect transistors, one having an extra channel implant to raise its pinch-off voltage. By running the two JFETs at the same drain current, the difference in pinch-off voltage can be amplified and used to form a highly stable voltage reference. The intrinsic reference voltage is around 0.5 V with a negative temperature coefficient of about -120 ppm/K. This slope is essentially locked to the dielectric constant of silicon and can be closely compensated by adding a correction term generated in the same fashion as the proportional-to-temperature (PTAT) term used to compensate band gap references. Because most of the noise of a band gap reference comes from the compensation circuitry, the intrinsic temperature coefficient offers a significant advantage (being about 30 times lower), and therefore, requiring less correction resulting in much lower noise.

The simplified schematic in Figure 31 shows the basic topology of the ADR291/ADR292 series. The temperature correction term is provided by a current source with a value designed to be proportional to absolute temperature. The general equation is

$$V_{OUT} = \Delta V_P \left(\frac{R1 + R2 + R3}{R1} \right) + (I_{PTAT})(R3)$$

where:

ΔV_P is the difference in pinch-off voltage between the two FETs.
 I_{PTAT} is the positive temperature coefficient correction current.

The various versions of the ADR291/ADR292 family are created by on-chip adjustment of R1 and R3 to achieve 2.500 V or 4.096 V at the reference output.

The process used for the XFET reference also features vertical NPN and PNP transistors, the latter of which are used as output devices to provide a very low dropout voltage.

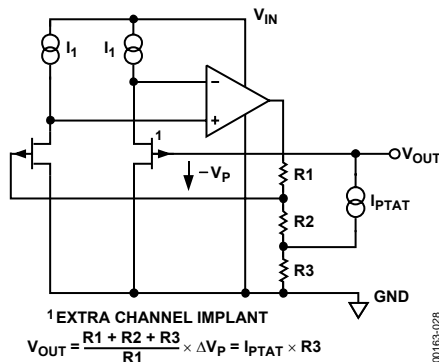

Figure 31. ADR291/ADR292 Simplified Schematic

DEVICE POWER DISSIPATION CONSIDERATIONS

The ADR291/ADR292 family of references is guaranteed to deliver load currents to 5 mA with an input voltage that ranges from 2.7 V to 15 V (minimum supply voltage depends on the output voltage chosen). When these devices are used in applications with large input voltages, care should be exercised to avoid exceeding the published specifications for maximum power dissipation or junction temperature that could result in premature device failure. Use the following formula to calculate maximum junction temperature or dissipation of a device:

$$P_D = \frac{T_J - T_A}{\theta_{JA}}$$

where

T_J and T_A are the junction and ambient temperatures, respectively.

P_D is the device power dissipation.

θ_{JA} is the device package thermal resistance.

BASIC VOLTAGE REFERENCE CONNECTIONS

References, in general, require a bypass capacitor connected from the V_{OUT} pin to the GND pin. The circuit in Figure 32 illustrates the basic configuration for the ADR291/ADR292 family of references. Note that the decoupling capacitors are not required for circuit stability.

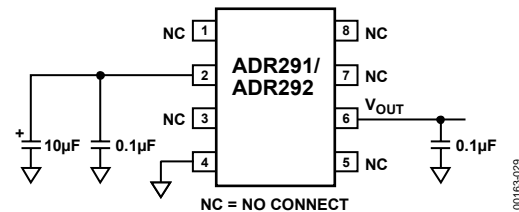

Figure 32. Basic Voltage Reference Configuration

NOISE PERFORMANCE

The noise generated by the ADR291/ADR292 family of references is typically less than 12 μ V p-p over the 0.1 Hz to 10 Hz band. The noise measurement is made with a band-pass filter made of a 2-pole high-pass filter with a corner frequency at 0.1 Hz and a 2-pole low-pass filter with a corner frequency at 10 Hz.

TURN-ON TIME

Upon application of power (cold start), the time required for the output voltage to reach its final value within a specified error band is defined as the turn-on settling time. Two components normally associated with this are the time it takes for the active circuits to settle and for the thermal gradients on the chip to stabilize. Figure 28 shows the turn-on settling time for the ADR291.

APPLICATIONS INFORMATION

NEGATIVE PRECISION REFERENCE WITHOUT PRECISION RESISTORS

In many current-output CMOS DAC applications, where the output signal voltage must be of the same polarity as the reference voltage, it is often necessary to reconfigure a current-switching DAC into a voltage-switching DAC through the use of a 1.25 V reference, an op amp, and a pair of resistors. Directly using a current-switching DAC requires an additional operational amplifier at the output to reinvert the signal. A negative voltage reference is then desirable from the point that an additional operational amplifier is not required for either reinversion (current-switching mode) or amplification (voltage-switching mode) of the DAC output voltage. In general, any positive voltage reference can be converted into a negative voltage reference through the use of an operational amplifier and a pair of matched resistors in an inverting configuration. The disadvantage to that approach is that the largest single source of error in the circuit is the relative matching of the resistors used.

The circuit illustrated in Figure 33 avoids the need for tightly matched resistors with the use of an active integrator circuit. In this circuit, the output of the voltage reference provides the input drive for the integrator. To maintain circuit equilibrium, the integrator adjusts its output to establish the proper relationship between the reference's V_{OUT} and GND. Thus, any negative output voltage desired can be chosen by simply substituting for the appropriate reference IC. There is one caveat with this approach: although rail-to-rail output amplifiers work best in the application, these operational amplifiers require a finite amount (mV) of headroom when required to provide any load current. The choice for the circuit's negative supply should take this issue into account.

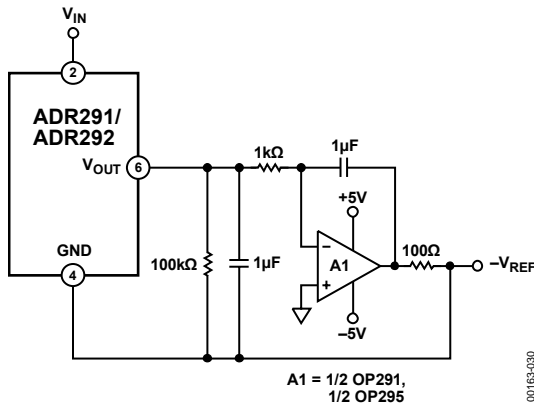

Figure 33. A Negative Precision Voltage Reference Uses No Precision Resistors

PRECISION CURRENT SOURCE

In low power applications, there is often a need for a precision current source that can operate on low supply voltages. As shown in Figure 34, any one of the devices in the ADR291/ADR292 family of references can be configured as a precision current source. The circuit configuration illustrated is a floating current source with a grounded load. The reference's output voltage is bootstrapped across R_{SET} , which sets the output current into the load. With this configuration, circuit precision is maintained for load currents in the range from the reference's supply current, typically 12 μ A to approximately 5 mA.

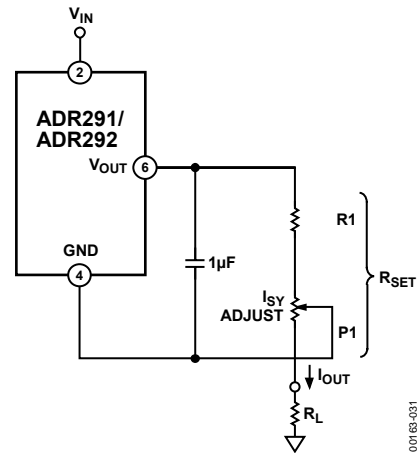

Figure 34. A Precision Current Source

HIGH VOLTAGE FLOATING CURRENT SOURCE

The circuit shown in Figure 35 can be used to generate a floating current source with minimal self-heating. This particular configuration operates on high supply voltages determined by the breakdown voltage of the N-channel JFET.

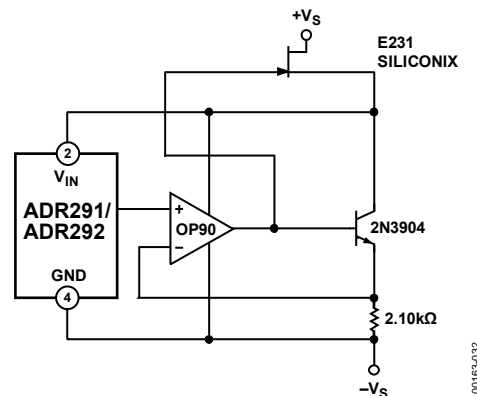
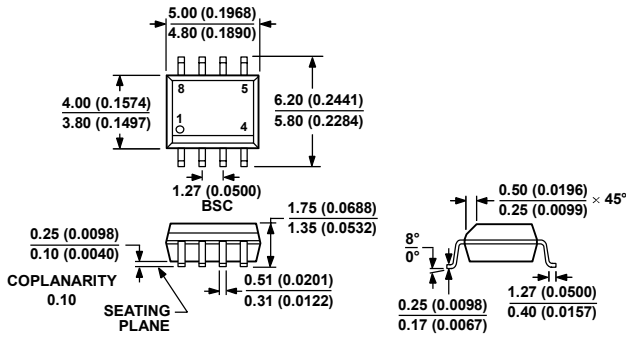

Figure 35. High Voltage Floating Current Source

OUTLINE DIMENSIONS



COMPLIANT TO JEDEC STANDARDS MS-012-AA
 CONTROLLING DIMENSIONS ARE IN MILLIMETERS; INCH DIMENSIONS (IN PARENTHESES) ARE ROUNDED-OFF MILLIMETER EQUIVALENTS FOR REFERENCE ONLY AND ARE NOT APPROPRIATE FOR USE IN DESIGN.

Figure 39. 8-Lead Standard Small Outline Package [SOIC_N]
 Narrow Body
 (R-8)
 Dimensions shown in millimeters and (inches)

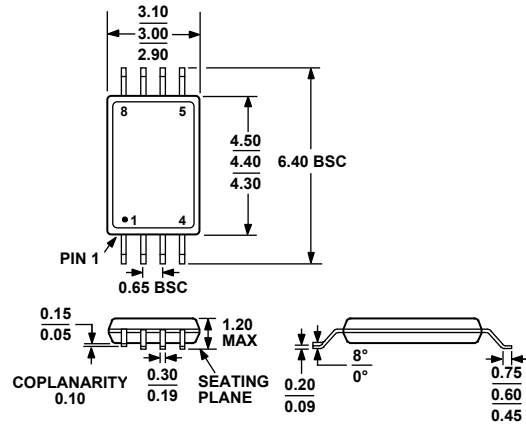

COMPLIANT TO JEDEC STANDARDS MO-153-AA

Figure 40. 8-Lead Thin Shrink Small Outline Package [TSSOP]
 (RU-8)
 Dimensions shown in millimeters

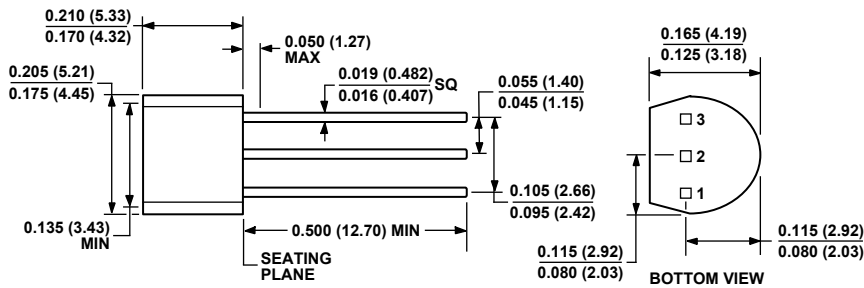

COMPLIANT TO JEDEC STANDARDS TO-226-AA
 CONTROLLING DIMENSIONS ARE IN INCHES; MILLIMETER DIMENSIONS (IN PARENTHESES) ARE ROUNDED-OFF EQUIVALENTS FOR REFERENCE ONLY AND ARE NOT APPROPRIATE FOR USE IN DESIGN.

Figure 41. 3-Lead Plastic Header-Style Package [TO-92]
 (T-3)
 Dimensions shown in inches and (millimeters)

ORDERING GUIDE

Model	Output Voltage	Initial Accuracy (±%)	Temperature Coefficient Max (ppm/°C)	Package Description	Package Option	Ordering Quantity
ADR291ER	2.50	0.08	8	8-Lead SOIC_N	R-8	98
ADR291ER-REEL7	2.50	0.08	8	8-Lead SOIC_N	R-8	1,000
ADR291ERZ ¹	2.50	0.08	8	8-Lead SOIC_N	R-8	98
ADR291ERZ-REEL7 ¹	2.50	0.08	8	8-Lead SOIC_N	R-8	1,000
ADR291FR	2.50	0.12	15	8-Lead SOIC_N	R-8	98
ADR291FR-REEL	2.50	0.12	15	8-Lead SOIC_N	R-8	2,500
ADR291FR-REEL7	2.50	0.12	15	8-Lead SOIC_N	R-8	1,000
ADR291FRZ ¹	2.50	0.12	15	8-Lead SOIC_N	R-8	98
ADR291FRZ-REEL ¹	2.50	0.12	15	8-Lead SOIC_N	R-8	2,500
ADR291FRZ-REEL7 ¹	2.50	0.12	15	8-Lead SOIC_N	R-8	1,000
ADR291GR	2.50	0.24	25	8-Lead SOIC_N	R-8	98
ADR291GR-REEL	2.50	0.24	25	8-Lead SOIC_N	R-8	2,500
ADR291GR-REEL7	2.50	0.24	25	8-Lead SOIC_N	R-8	1,000
ADR291GRZ ¹	2.50	0.24	25	8-Lead SOIC_N	R-8	98
ADR291GRZ-REEL ¹	2.50	0.24	25	8-Lead SOIC_N	R-8	2,500
ADR291GRZ-REEL7 ¹	2.50	0.24	25	8-Lead SOIC_N	R-8	1,000
ADR291GRU	2.50	0.24	25	8-Lead TSSOP	RU-8	98
ADR291GRU-REEL7	2.50	0.24	25	8-Lead TSSOP	RU-8	1,000
ADR291GRUZ ¹	2.50	0.24	25	8-Lead TSSOP	RU-8	98
ADR291GRUZ-REEL ¹	2.50	0.24	25	8-Lead TSSOP	RU-8	1,000
ADR291GRUZ-REEL7 ¹	2.50	0.24	25	8-Lead TSSOP	RU-8	1,000
ADR291GT9	2.50	0.24	25	3-Lead TO-92	T-3	98
ADR291GT9-REEL	2.50	0.24	25	3-Lead TO-92	T-3	2,000
ADR291GT9Z ¹	2.50	0.24	25	3-Lead TO-92	T-3	98
ADR292ER	4.096	0.07	8	8-Lead SOIC_N	R-8	98
ADR292ER-REEL	4.096	0.07	8	8-Lead SOIC_N	R-8	2,500
ADR292ERZ ¹	4.096	0.07	8	8-Lead SOIC_N	R-8	98
ADR292ERZ-REEL ¹	4.096	0.07	8	8-Lead SOIC_N	R-8	2,500
ADR292FR	4.096	0.10	15	8-Lead SOIC_N	R-8	98
ADR292FR-REEL	4.096	0.10	15	8-Lead SOIC_N	R-8	2,500
ADR292FR-REEL7	4.096	0.10	15	8-Lead SOIC_N	R-8	1,000
ADR292FRZ ¹	4.096	0.10	15	8-Lead SOIC_N	R-8	98
ADR292FRZ-REEL ¹	4.096	0.10	15	8-Lead SOIC_N	R-8	2,500
ADR292FRZ-REEL7 ¹	4.096	0.10	15	8-Lead SOIC_N	R-8	1,000
ADR292GR	4.096	0.15	25	8-Lead SOIC_N	R-8	98
ADR292GR-REEL7	4.096	0.15	25	8-Lead SOIC_N	R-8	1,000
ADR292GRZ ¹	4.096	0.15	25	8-Lead SOIC_N	R-8	98
ADR292GRZ-REEL7 ¹	4.096	0.15	25	8-Lead SOIC_N	R-8	1,000
ADR292GRU	4.096	0.24	25	8-Lead TSSOP	RU-8	98
ADR292GRU-REEL7	4.096	0.15	25	8-Lead TSSOP	RU-8	1,000
ADR292GRUZ ¹	4.096	0.24	25	8-Lead TSSOP	RU-8	98
ADR292GRUZ-REEL7 ¹	4.096	0.15	25	8-Lead TSSOP	RU-8	1,000

¹ Z = RoHS Compliant Part.

ADR291/ADR292

NOTES

NOTES

NOTES