



18-Mbit (512K × 36/1M × 18) Flow-Through SRAM with NoBL™ Architecture (With ECC)

Features

- No Bus Latency™ (NoBL™) architecture eliminates dead cycles between write and read cycles
- Supports up to 133 MHz bus operations with zero wait states
 - Data is transferred on every clock
- Pin-compatible and functionally equivalent to ZBT™ devices
- Internally self-timed output buffer control to eliminate the need to use OE
- Registered inputs for flow through operation
- Byte write capability
- 3.3 V/2.5 V I/O power supply (V_{DDQ})
- Fast clock-to-output times
 - 6.5 ns (for 133 MHz device)
- Clock enable (\overline{CEN}) pin to enable clock and suspend operation
- Synchronous self-timed writes
- Asynchronous output enable
- Available in JEDEC-standard Pb-free 100-pin TQFP packages
- Three chip enables for simple depth expansion
- Automatic power-down feature available using ZZ mode or CE deselect
- Burst capability – linear or interleaved burst order
- Low standby power
- On chip Error Correction Code (ECC) to reduce Soft Error Rate (SER)

Functional Description

The CY7C1371KV33/CY7C1371KVE33/CY7C1373KV33 are 3.3 V, 512K × 36/1M × 18 synchronous flow through burst SRAM designed specifically to support unlimited true back-to-back read/write operations with no wait state insertion. The CY7C1371KV33/CY7C1371KVE33/CY7C1373KV33 are equipped with the advanced No Bus Latency (NoBL) logic required to enable consecutive read/write operations with data being transferred on every clock cycle. This feature dramatically improves the throughput of data through the SRAM, especially in systems that require frequent write-read transitions.

All synchronous inputs pass through input registers controlled by the rising edge of the clock. The clock input is qualified by the clock enable (\overline{CEN}) signal, which when deasserted suspends operation and extends the previous clock cycle. Maximum access delay from the clock rise is 6.5 ns (133 MHz device).

Write operations are controlled by the two or four byte write select (BW_X) and a write enable (\overline{WE}) input. All writes are conducted with on-chip synchronous self-timed write circuitry.

Three synchronous chip enables (\overline{CE}_1 , \overline{CE}_2 , \overline{CE}_3) and an asynchronous output enable (\overline{OE}) provide for easy bank selection and output tristate control. To avoid bus contention, the output drivers are synchronously tristated during the data portion of a write sequence.

Selection Guide

Description		133 MHz	100 MHz	Unit
Maximum access time		6.5	8.5	ns
Maximum operating current	× 18	129	114	mA
	× 36	149	134	mA

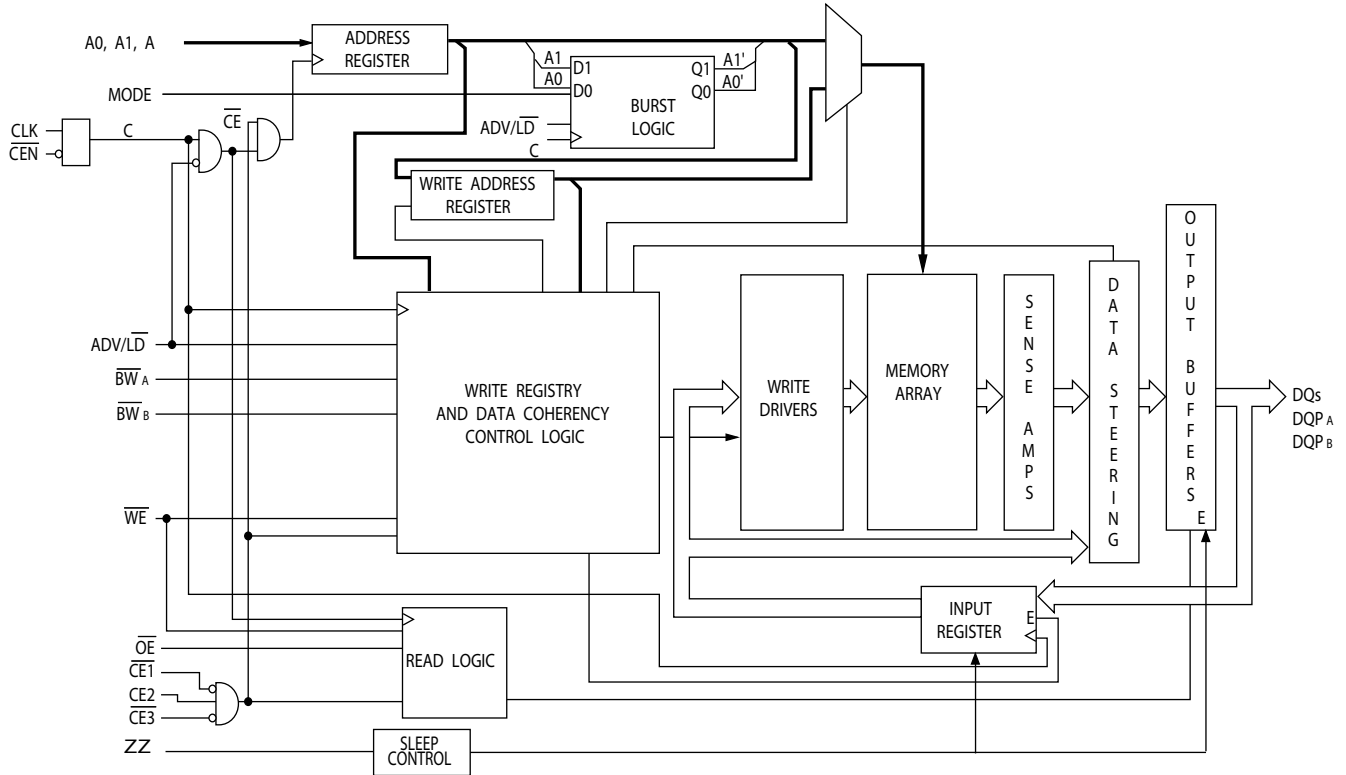
Logic Block Diagram – CY7C1373KV33

Contents

Pin Configurations	5	Capacitance	15
Pin Definitions	7	Thermal Resistance	15
Functional Overview	9	AC Test Loads and Waveforms	15
Single Read Accesses	9	Switching Characteristics	16
Burst Read Accesses	9	Switching Waveforms	17
Single Write Accesses	9	Ordering Information	20
Burst Write Accesses	9	Ordering Code Definitions	20
Sleep Mode	10	Package Diagrams	21
Interleaved Burst Address Table	10	Acronyms	22
Linear Burst Address Table	10	Document Conventions	22
ZZ Mode Electrical Characteristics	10	Units of Measure	22
Truth Table	11	Document History Page	23
Partial Truth Table for Read/Write	12	Sales, Solutions, and Legal Information	24
Partial Truth Table for Read/Write	12	Worldwide Sales and Design Support	24
Maximum Ratings	13	Products	24
Operating Range	13	PSoC® Solutions	24
Neutron Soft Error Immunity	13	Cypress Developer Community	24
Electrical Characteristics	13	Technical Support	24

Pin Configurations

Figure 1. 100-pin TQFP (14 × 20 × 1.4 mm) pinout

CY7C1371KV33/CY7C1371KVE33

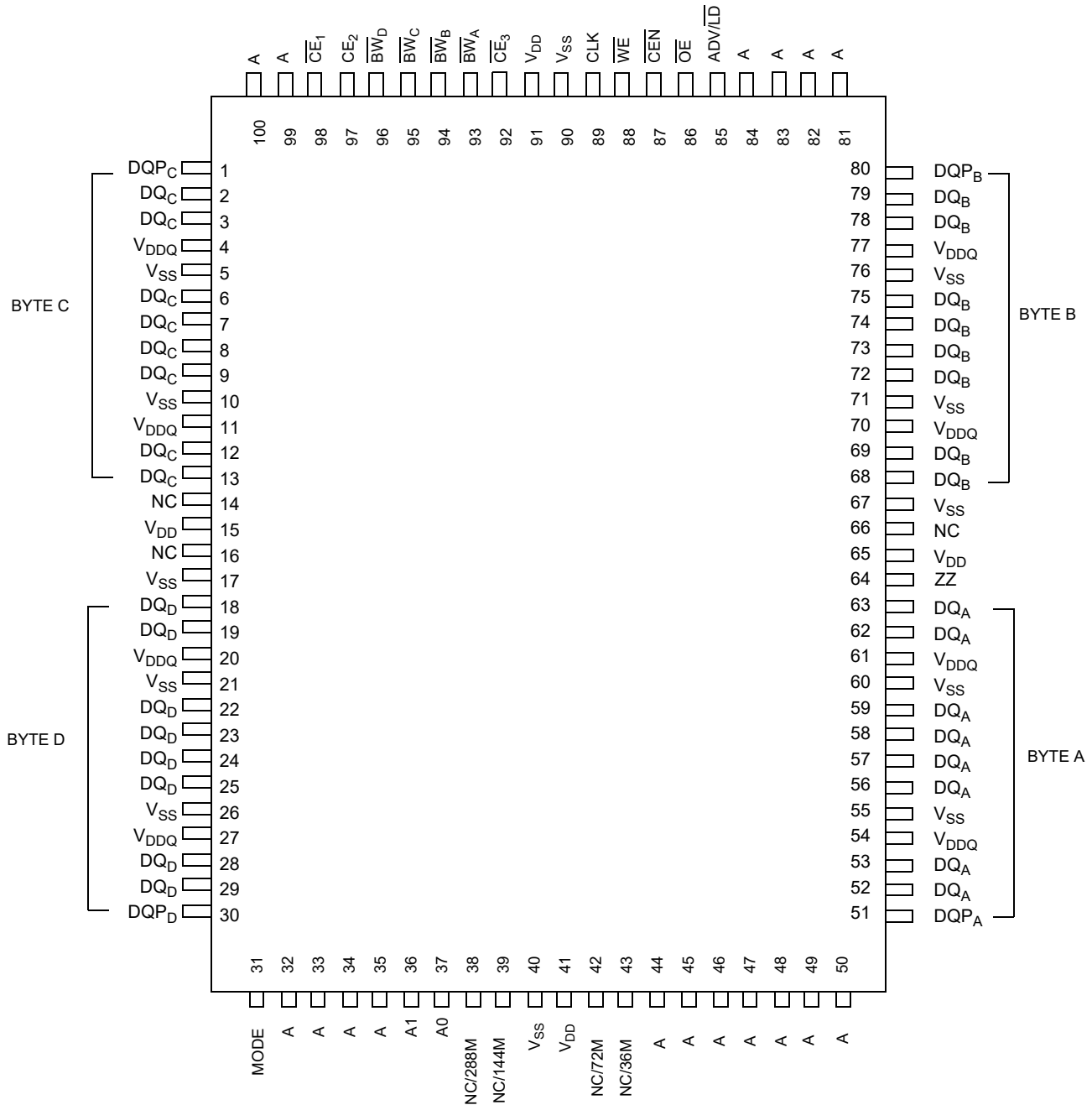

Pin Configurations (continued)

Figure 2. 100-pin TQFP (14 × 20 × 1.4 mm) pinout

CY7C1373KV33

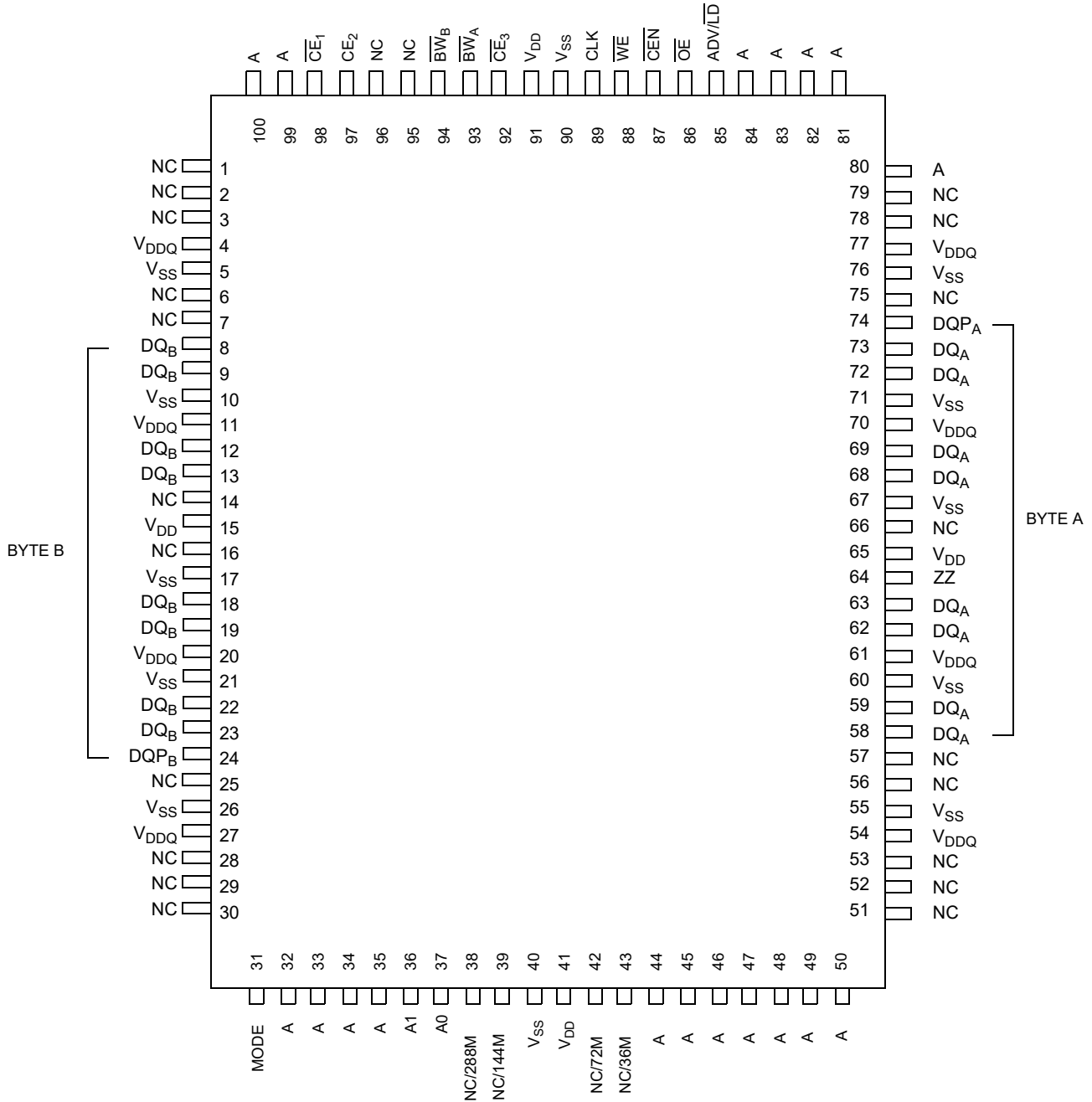

Pin Definitions

Name	I/O	Description
A ₀ , A ₁ , A	Input-synchronous	Address inputs used to select one of the address locations. Sampled at the rising edge of the CLK. A _[1:0] are fed to the two-bit burst counter.
\overline{BW}_A , \overline{BW}_B , \overline{BW}_C , \overline{BW}_D	Input-synchronous	Byte write inputs, active LOW. Qualified with \overline{WE} to conduct writes to the SRAM. Sampled on the rising edge of CLK.
\overline{WE}	Input-synchronous	Write enable input, active LOW. Sampled on the rising edge of CLK if \overline{CEN} is active LOW. This signal must be asserted LOW to initiate a write sequence.
ADV/ \overline{LD}	Input-synchronous	Advance/load input. Used to advance the on-chip address counter or load a new address. When HIGH (and \overline{CEN} is asserted LOW) the internal burst counter is advanced. When LOW, a new address can be loaded into the device for an access. After being deselected, ADV/ \overline{LD} must be driven LOW to load a new address.
CLK	Input-clock	Clock input. Used to capture all synchronous inputs to the device. CLK is qualified with \overline{CEN} . CLK is only recognized if \overline{CEN} is active LOW.
\overline{CE}_1	Input-synchronous	Chip enable 1 input, active LOW. Sampled on the rising edge of CLK. Used in conjunction with \overline{CE}_2 and \overline{CE}_3 to select/deselect the device.
\overline{CE}_2	Input-synchronous	Chip enable 2 input, active HIGH. Sampled on the rising edge of CLK. Used in conjunction with \overline{CE}_1 and \overline{CE}_3 to select/deselect the device.
\overline{CE}_3	Input-synchronous	Chip enable 3 input, active LOW. Sampled on the rising edge of CLK. Used in conjunction with \overline{CE}_1 and \overline{CE}_2 to select/deselect the device.
\overline{OE}	Input-asynchronous	Output enable, asynchronous input, active LOW. Combined with the synchronous logic block inside the device to control the direction of the I/O pins. When LOW, the I/O pins are allowed to behave as outputs. When deasserted HIGH, I/O pins are tristated, and act as input data pins. \overline{OE} is masked during the data portion of a write sequence, during the first clock when emerging from a deselected state, when the device has been deselected.
\overline{CEN}	Input-synchronous	Clock enable input, active LOW. When asserted LOW the Clock signal is recognized by the SRAM. When deasserted HIGH the Clock signal is masked. While deasserting \overline{CEN} does not deselect the device, use \overline{CEN} to extend the previous cycle when required.
ZZ	Input-asynchronous	ZZ "sleep" input. This active HIGH input places the device in a non-time critical "sleep" condition with data integrity preserved. For normal operation, this pin has to be LOW or left floating. ZZ pin has an internal pull-down.

Pin Definitions (continued)

Name	I/O	Description
DQ _s	I/O-synchronous	Bidirectional data I/O lines. As inputs, they feed into an on-chip data register that is triggered by the rising edge of CLK. As outputs, they deliver the data contained in the memory location specified by the addresses presented during the previous clock rise of the read cycle. The direction of the pins is controlled by OE. When OE is asserted LOW, the pins behave as outputs. When HIGH, DQ _s and DQP _[A:D] are placed in a tristate condition. The outputs are automatically tristated during the data portion of a write sequence, during the first clock when emerging from a deselected state, and when the device is deselected, regardless of the state of OE.
DQP _x	I/O-synchronous	Bidirectional data parity I/O lines. Functionally, these signals are identical to DQ _s .
MODE	Input strap pin	Mode input. Selects the burst order of the device. When tied to Gnd selects linear burst sequence. When tied to V _{DD} or left floating selects interleaved burst sequence.
V _{DD}	Power supply	Power supply inputs to the core of the device.
V _{DDQ}	I/O power supply	Power supply for the I/O circuitry.
V _{SS}	Ground	Ground for the device.
NC	–	No connects. Not internally connected to the die. NC/(36M, 72M, 144M, 288M, 576M, 1G) are address expansion pins and are not internally connected to the die.

Functional Overview

The CY7C1371KV33/CY7C1371KVE33/CY7C1373KV33 is a synchronous flow through burst SRAM designed specifically to eliminate wait states during write-read transitions. All synchronous inputs pass through input registers controlled by the rising edge of the clock. The clock signal is qualified with the clock enable input signal (\overline{CEN}). If \overline{CEN} is HIGH, the clock signal is not recognized and all internal states are maintained. All synchronous operations are qualified with \overline{CEN} . Maximum access delay from the clock rise (t_{CDV}) is 6.5 ns (133 MHz device).

Accesses can be initiated by asserting all three chip enables (\overline{CE}_1 , \overline{CE}_2 , \overline{CE}_3) active at the rising edge of the clock. If clock enable (\overline{CEN}) is active LOW and $\overline{ADV/LD}$ is asserted LOW, the address presented to the device is latched. The access can either be a read or write operation, depending on the status of the write enable (\overline{WE}). \overline{BW}_X can be used to conduct byte write operations.

Write operations are qualified by the write enable (\overline{WE}). All writes are simplified with on-chip synchronous self-timed write circuitry.

Three synchronous chip enables (\overline{CE}_1 , \overline{CE}_2 , \overline{CE}_3) and an asynchronous output enable (\overline{OE}) simplify depth expansion. All operations (reads, writes, and deselections) are pipelined. $\overline{ADV/LD}$ must be driven LOW after the device has been deselected to load a new address for the next operation.

Single Read Accesses

A read access is initiated when these conditions are satisfied at clock rise:

- \overline{CEN} is asserted LOW
- \overline{CE}_1 , \overline{CE}_2 , and \overline{CE}_3 are all asserted active
- The write enable input signal \overline{WE} is deasserted HIGH
- $\overline{ADV/LD}$ is asserted LOW.

The address presented to the address inputs is latched into the address register and presented to the memory array and control logic. The control logic determines that a read access is in progress and allows the requested data to propagate to the output buffers. The data is available within 6.5 ns (133-MHz device) provided \overline{OE} is active LOW. After the first clock of the read access, the output buffers are controlled by \overline{OE} and the internal control logic. \overline{OE} must be driven LOW in order for the device to drive out the requested data. On the subsequent clock, another operation (read/write/deselect) can be initiated. When the SRAM is deselected at clock rise by one of the chip enable signals, its output is tristated immediately.

Burst Read Accesses

The CY7C1371KV33/CY7C1371KVE33/CY7C1373KV33 has an on-chip burst counter that allows the user the ability to supply a single address and conduct up to four reads without reasserting the address inputs. $\overline{ADV/LD}$ must be driven LOW to load a new address into the SRAM, as described in the [Single](#)

[Read Accesses](#) section above. The sequence of the burst counter is determined by the MODE input signal. A LOW input on MODE selects a linear burst mode, a HIGH selects an interleaved burst sequence. Both burst counters use A_0 and A_1 in the burst sequence, and wraps around when incremented sufficiently. A HIGH input on $\overline{ADV/LD}$ increments the internal burst counter regardless of the state of chip enable inputs or \overline{WE} . \overline{WE} is latched at the beginning of a burst cycle. Therefore, the type of access (read or write) is maintained throughout the burst sequence.

Single Write Accesses

Write access are initiated when the following conditions are satisfied at clock rise: (1) \overline{CEN} is asserted LOW, (2) \overline{CE}_1 , \overline{CE}_2 , and \overline{CE}_3 are all asserted active, and (3) the write signal \overline{WE} is asserted LOW. The address presented to the address bus is loaded into the address register. The write signals are latched into the control logic block. The data lines are automatically tristated regardless of the state of the \overline{OE} input signal. This allows the external logic to present the data on DQs and \overline{DQP}_X .

On the next clock rise the data presented to DQs and \overline{DQP}_X (or a subset for byte write operations, see truth table for details) inputs is latched into the device and the write is complete. Additional accesses (read/write/deselect) can be initiated on this cycle.

The data written during the write operation is controlled by \overline{BW}_X signals. The CY7C1371KV33/CY7C1371KVE33/ CY7C1373KV33 provides byte write capability that is described in the truth table. Asserting the write enable input (\overline{WE}) with the selected byte write select input selectively writes to only the desired bytes. Bytes not selected during a byte write operation remains unaltered. A synchronous self-timed write mechanism has been provided to simplify the write operations. Byte write capability has been included to greatly simplify read/modify/write sequences, which can be reduced to simple byte write operations.

Because the CY7C1371KV33/CY7C1371KVE33/ CY7C1373KV33 is a common I/O device, data must not be driven into the device while the outputs are active. The output enable (\overline{OE}) can be deasserted HIGH before presenting data to the DQs and \overline{DQP}_X inputs. Doing so tristates the output drivers. As a safety precaution, DQs and \overline{DQP}_X are automatically tristated during the data portion of a write cycle, regardless of the state of \overline{OE} .

Burst Write Accesses

The CY7C1371KV33/CY7C1371KVE33/CY7C1373KV33 has an on-chip burst counter that allows the user the ability to supply a single address and conduct up to four write operations without reasserting the address inputs. $\overline{ADV/LD}$ must be driven LOW to load the initial address, as described in the [Single Write Accesses](#) section above. When $\overline{ADV/LD}$ is driven HIGH on the subsequent clock rise, the chip enables (\overline{CE}_1 , \overline{CE}_2 , and \overline{CE}_3) and \overline{WE} inputs are ignored and the burst counter is incremented. The correct \overline{BW}_X inputs must be driven in each cycle of the burst write, to write the correct bytes of data.

Sleep Mode

The ZZ input pin is an asynchronous input. Asserting ZZ places the SRAM in a power conservation “sleep” mode. Two clock cycles are required to enter into or exit from this “sleep” mode. While in this mode, data integrity is guaranteed. Accesses pending when entering the “sleep” mode are not considered valid nor is the completion of the operation guaranteed. The device must be deselected prior to entering the “sleep” mode. CE₁, CE₂, and CE₃, must remain inactive for the duration of t_{ZZREC} after the ZZ input returns LOW.

Interleaved Burst Address Table

(MODE = Floating or V_{DD})

First Address A1:A0	Second Address A1:A0	Third Address A1:A0	Fourth Address A1:A0
00	01	10	11
01	00	11	10
10	11	00	01
11	10	01	00

Linear Burst Address Table

(MODE = GND)

First Address A1:A0	Second Address A1:A0	Third Address A1:A0	Fourth Address A1:A0
00	01	10	11
01	10	11	00
10	11	00	01
11	00	01	10

ZZ Mode Electrical Characteristics

Parameter	Description	Test Conditions	Min	Max	Unit
I _{DDZZ}	Sleep mode standby current	ZZ ≥ V _{DD} - 0.2 V	–	65	mA
t _{ZZS}	Device operation to ZZ	ZZ ≥ V _{DD} - 0.2 V	–	2t _{CYC}	ns
t _{ZZREC}	ZZ recovery time	ZZ ≤ 0.2 V	2t _{CYC}	–	ns
t _{ZZI}	ZZ active to sleep current	This parameter is sampled	–	2t _{CYC}	ns
t _{RZZI}	ZZ Inactive to exit sleep current	This parameter is sampled	0	–	ns

Truth Table

The truth table for CY7C1371KV33/CY7C1371KVE33/CY7C1373KV33 are as follows. [1, 2, 3, 4, 5, 6, 7]

Operation	Address Used	\overline{CE}_1	CE_2	\overline{CE}_3	ZZ	ADV/LD	\overline{WE}	\overline{BW}_X	\overline{OE}	\overline{CEN}	CLK	DQ
Deselect cycle	None	H	X	X	L	L	X	X	X	L	L->H	Tristate
Deselect cycle	None	X	X	H	L	L	X	X	X	L	L->H	Tristate
Deselect cycle	None	X	L	X	L	L	X	X	X	L	L->H	Tristate
Continue deselect cycle	None	X	X	X	L	H	X	X	X	L	L->H	Tristate
Read cycle (begin burst)	External	L	H	L	L	L	H	X	L	L	L->H	Data out (Q)
Read cycle (continue burst)	Next	X	X	X	L	H	X	X	L	L	L->H	Data out (Q)
NOP/dummy read (begin burst)	External	L	H	L	L	L	H	X	H	L	L->H	Tristate
Dummy read (continue burst)	Next	X	X	X	L	H	X	X	H	L	L->H	Tristate
Write cycle (begin burst)	External	L	H	L	L	L	L	L	X	L	L->H	Data in (D)
Write cycle (continue burst)	Next	X	X	X	L	H	X	L	X	L	L->H	Data in (D)
NOP/write abort (begin burst)	None	L	H	L	L	L	L	H	X	L	L->H	Tristate
Write abort (continue burst)	Next	X	X	X	L	H	X	H	X	L	L->H	Tristate
Ignore clock edge (stall)	Current	X	X	X	L	X	X	X	X	H	L->H	–
Sleep mode	None	X	X	X	H	X	X	X	X	X	X	Tristate

Notes

1. X = "Don't Care." H = Logic HIGH, L = Logic LOW. $\overline{BW}_X = 0$ signifies at least one byte write select is active, $\overline{BW}_X = \text{valid}$ signifies that the desired byte write selects are asserted, see truth table for details.
2. Write is defined by \overline{BW}_X , and \overline{WE} . See Truth Table for read/write.
3. When a write cycle is detected, all I/Os are tristated, even during byte writes.
4. The DQs and DQP_X pins are controlled by the current cycle and the \overline{OE} signal. \overline{OE} is asynchronous and is not sampled with the clock.
5. $\overline{CEN} = H$, inserts wait states.
6. Device powers up deselected and the I/Os in a tristate condition, regardless of \overline{OE} .
7. \overline{OE} is asynchronous and is not sampled with the clock rise. It is masked internally during write cycles. During a read cycle DQs and $DQP_X = \text{tristate}$ when \overline{OE} is inactive or when the device is deselected, and DQs and $DQP_X = \text{data}$ when \overline{OE} is active.

Partial Truth Table for Read/Write

The Partial Truth Table for Read/Write for CY7C1371KV33/CY7C1371KVE33 follows. [8, 9, 10]

Function (CY7C1371KV33/CY7C1371KVE33)	\overline{WE}	\overline{BW}_A	\overline{BW}_B	\overline{BW}_C	\overline{BW}_D
Read	H	X	X	X	X
Write no bytes written	L	H	H	H	H
Write byte A – (DQ _A and DQP _A)	L	L	H	H	H
Write byte B – (DQ _B and DQP _B)	L	H	L	H	H
Write byte C – (DQ _C and DQP _C)	L	H	H	L	H
Write byte D – (DQ _D and DQP _D)	L	H	H	H	L
Write all Bytes	L	L	L	L	L

Partial Truth Table for Read/Write

The Partial Truth Table for Read/Write for CY7C1373KV33 follows. [8, 9, 10]

Function (CY7C1373KV33)	\overline{WE}	\overline{BW}_A	\overline{BW}_B
Read	H	X	X
Write - no bytes written	L	H	H
Write byte A – (DQ _A and DQP _A)	L	L	H
Write byte B – (DQ _B and DQP _B)	L	H	L
Write all bytes	L	L	L

Notes

8. X = "Don't Care." H = Logic HIGH, L = Logic LOW. $\overline{BW}_X = 0$ signifies at least one byte write select is active, $\overline{BW}_X = \text{valid}$ signifies that the desired byte write selects are asserted, see [Truth Table on page 11](#) for details.
9. Write is defined by \overline{BW}_X , and \overline{WE} . See [Truth Table on page 11](#) for read/write.
10. Table only lists a partial listing of the byte write combinations. Any Combination of \overline{BW}_X is valid Appropriate write is based on which byte write is active.

Maximum Ratings

Exceeding maximum ratings may impair the useful life of the device. These user guidelines are not tested.

Storage temperature	-65 °C to +150 °C
Ambient temperature with power applied	-55 °C to +125 °C
Supply voltage on V _{DD} relative to GND	-0.5 V to +4.6 V
Supply voltage on V _{DDQ} relative to GND	-0.5 V to +V _{DD}
DC voltage applied to outputs in tristate	-0.5 V to V _{DDQ} + 0.5 V
DC input voltage	-0.5 V to V _{DD} + 0.5 V
Current into outputs (LOW)	20 mA
Static discharge voltage (MIL-STD-883, method 3015)	> 2001 V
Latch up current	> 200 mA

Operating Range

Range	Ambient Temperature	V _{DD}	V _{DDQ}
Commercial	0 °C to +70 °C	3.3 V – 5% / + 10%	2.5 V – 5% to V _{DD}
Industrial	-40 °C to +85 °C		

Neutron Soft Error Immunity

Parameter	Description	Test Conditions	Typ	Max*	Unit
LSBU (Device without ECC)	Logical Single-Bit Upsets	25 °C	<5	5	FIT/Mb
			0	0.01	FIT/Mb
LMBU	Logical Multi-Bit Upsets	25 °C	0	0.01	FIT/Mb
SEL	Single Event Latch up	85 °C	0	0.1	FIT/Dev

* No LMBU or SEL events occurred during testing; this column represents a statistical χ^2 , 95% confidence limit calculation. For more details refer to Application Note AN54908 "Accelerated Neutron SER Testing and Calculation of Terrestrial Failure Rates".

Electrical Characteristics

Over the Operating Range

Parameter ^[11, 12]	Description	Test Conditions	Min	Max	Unit
V _{DD}	Power Supply Voltage		3.135	3.6	V
V _{DDQ}	I/O Supply Voltage	for 3.3 V I/O	3.135	V _{DD}	V
		for 2.5 V I/O	2.375	2.625	V
V _{OH}	Output HIGH Voltage	for 3.3 V I/O, I _{OH} = -4.0 mA	2.4	-	V
		for 2.5 V I/O, I _{OH} = -1.0 mA	2.0	-	V
V _{OL}	Output LOW Voltage	for 3.3 V I/O, I _{OL} = 8.0 mA	-	0.4	V
		for 2.5 V I/O, I _{OL} = 1.0 mA	-	0.4	V
V _{IH}	Input HIGH Voltage ^[11]	for 3.3 V I/O	2.0	V _{DD} + 0.3	V
		for 2.5 V I/O	1.7	V _{DD} + 0.3	V
V _{IL}	Input LOW Voltage ^[11]	for 3.3 V I/O	-0.3	0.8	V
		for 2.5 V I/O	-0.3	0.7	V
I _X	Input Leakage Current except ZZ and MODE	GND ≤ V _I ≤ V _{DDQ}	-5	5	μA
	Input Current of MODE	Input = V _{SS}	-30	-	μA
		Input = V _{DD}	-	5	μA
	Input Current of ZZ	Input = V _{SS}	-5	-	μA
Input = V _{DD}		-	30	μA	

Notes

- Overshoot: V_{IH(AC)} < V_{DD} + 1.5 V (Pulse width less than t_{CYC/2}), undershoot: V_{IL(AC)} > -2 V (Pulse width less than t_{CYC/2}).
- T_{Power-up}: Assumes a linear ramp from 0 V to V_{DD(min.)} of at least 200 ms. During this time V_{IH} < V_{DD} and V_{DDQ} ≤ V_{DD}.

Electrical Characteristics (continued)

Over the Operating Range

Parameter ^[11, 12]	Description	Test Conditions		Min	Max	Unit	
I_{OZ}	Output Leakage Current	GND $\leq V_I \leq V_{DDQ}$, Output Disabled		-5	5	μ A	
I_{DD}	V_{DD} Operating Supply	$V_{DD} = \text{Max.}$, $I_{OUT} = 0 \text{ mA}$, $f = f_{MAX} = 1/t_{CYC}$	100 MHz	× 18	-	114	mA
				× 36	-	134	
			133 MHz	× 18	-	129	
				× 36	-	149	
I_{SB1}	Automatic CE Power-down Current – TTL Inputs	Max. V_{DD} , Device Deselected, $V_{IN} \geq V_{IH}$ or $V_{IN} \leq V_{IL}$, $f = f_{MAX} = 1/t_{CYC}$	100 MHz	× 18	-	75	mA
				× 36	-	80	
			133 MHz	× 18	-	75	
				× 36	-	80	
I_{SB2}	Automatic CE Power-down Current – CMOS Inputs	Max. V_{DD} , Device Deselected, $V_{IN} \leq 0.3 \text{ V}$ or $V_{IN} \geq V_{DDQ} - 0.3 \text{ V}$, $f = 0$	All speed grades	× 18	-	65	mA
				× 36	-	70	
I_{SB3}	Automatic CE Power-down Current – CMOS Inputs	Max. V_{DD} , Device Deselected, $V_{IN} \leq 0.3 \text{ V}$ or $V_{IN} \geq V_{DDQ} - 0.3 \text{ V}$, $f = f_{MAX} = 1/t_{CYC}$	100 MHz	× 18	-	75	mA
				× 36	-	80	
			133 MHz	× 18	-	75	
				× 36	-	80	
I_{SB4}	Automatic CE Power-down Current – TTL Inputs	Max. V_{DD} , Device Deselected, $V_{IN} \geq V_{IH}$ or $V_{IN} \leq V_{IL}$, $f = 0$	All speed grades	× 18	-	65	mA
				× 36	-	70	

Capacitance

Parameter	Description	Test Conditions	100-pin TQFP Package	Unit
C_{IN}	Input capacitance	$T_A = 25\text{ }^\circ\text{C}$, $f = 1\text{ MHz}$, $V_{DD} = 3.3\text{ V}$, $V_{DDQ} = 2.5\text{ V}$	5	pF
C_{CLK}	Clock input capacitance		5	pF
C_{IO}	Input/output capacitance		5	pF

Thermal Resistance

Parameter	Description	Test Conditions	100-pin TQFP Package	Unit	
Θ_{JA}	Thermal resistance (junction to ambient)	Test conditions follow standard test methods and procedures for measuring thermal impedance, per EIA/JESD51.	With Still Air (0 m/s)	37.95	$^\circ\text{C/W}$
			With Air Flow (1 m/s)	33.19	$^\circ\text{C/W}$
			With Air Flow (3 m/s)	30.44	$^\circ\text{C/W}$
Θ_{JB}	Thermal resistance (junction to board)		--	24.07	$^\circ\text{C/W}$
Θ_{JC}	Thermal resistance (junction to case)			8.36	$^\circ\text{C/W}$

AC Test Loads and Waveforms

Figure 3. AC Test Loads and Waveforms

3.3 V I/O Test Load

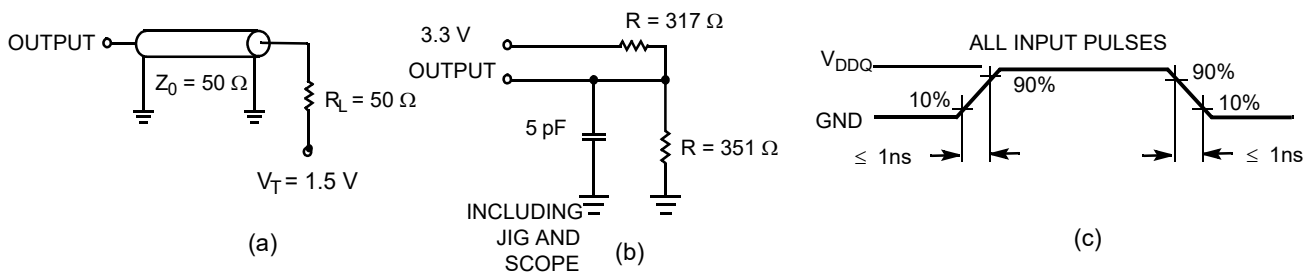

2.5 V I/O Test Load

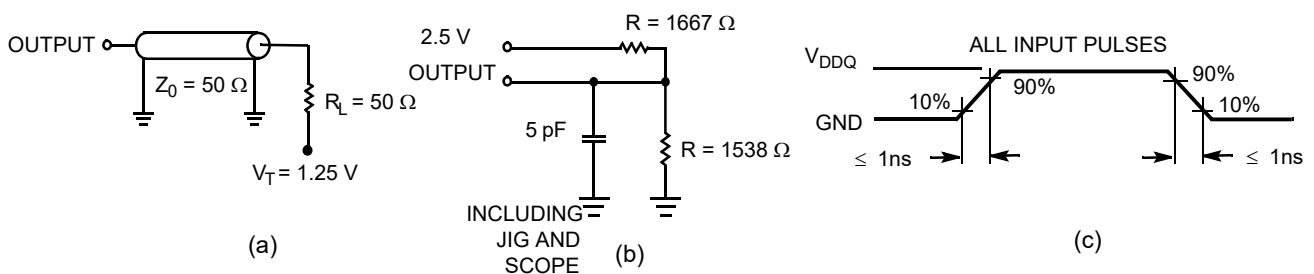

Switching Characteristics

Over the Operating Range

Parameter [13, 14]	Description	133 MHz		100 MHz		Unit
		Min	Max	Min	Max	
t _{POWER}	V _{DD} (typical) to the first access [15]	1	–	1	–	ms
Clock						
t _{CYC}	Clock cycle time	7.5	–	10	–	ns
t _{CH}	Clock HIGH	2.1	–	2.5	–	ns
t _{CL}	Clock LOW	2.1	–	2.5	–	ns
Output Times						
t _{CDV}	Data output valid after CLK rise	–	6.5	–	8.5	ns
t _{DOH}	Data output hold after CLK rise	2.0	–	2.0	–	ns
t _{CLZ}	Clock to low Z [16, 17, 18]	2.0	–	2.0	–	ns
t _{CHZ}	Clock to high Z [16, 17, 18]	–	4.0	–	5.0	ns
t _{OEV}	$\overline{\text{OE}}$ LOW to output valid	–	3.2	–	3.8	ns
t _{OELZ}	$\overline{\text{OE}}$ LOW to output low Z [16, 17, 18]	0	–	0	–	ns
t _{OEZH}	$\overline{\text{OE}}$ HIGH to output high Z [16, 17, 18]	–	4.0	–	5.0	ns
Setup Times						
t _{AS}	Address setup before CLK rise	1.5	–	1.5	–	ns
t _{ALS}	ADV/LD setup before CLK rise	1.5	–	1.5	–	ns
t _{WES}	$\overline{\text{WE}}$, $\overline{\text{BW}}_X$ setup before CLK rise	1.5	–	1.5	–	ns
t _{CENS}	$\overline{\text{CEN}}$ setup before CLK rise	1.5	–	1.5	–	ns
t _{DS}	Data input setup before CLK rise	1.5	–	1.5	–	ns
t _{CES}	Chip enable setup before CLK rise	1.5	–	1.5	–	ns
Hold Times						
t _{AH}	Address hold after CLK rise	0.5	–	0.5	–	ns
t _{ALH}	ADV/LD hold after CLK rise	0.5	–	0.5	–	ns
t _{WEH}	$\overline{\text{WE}}$, $\overline{\text{BW}}_X$ hold after CLK rise	0.5	–	0.5	–	ns
t _{CENH}	$\overline{\text{CEN}}$ hold after CLK rise	0.5	–	0.5	–	ns
t _{DH}	Data input hold after CLK rise	0.5	–	0.5	–	ns
t _{CEH}	Chip enable hold after CLK rise	0.5	–	0.5	–	ns

Notes

13. Timing reference level is 1.5 V when V_{DDQ} = 3.3 V and is 1.25 V when V_{DDQ} = 2.5 V.

14. Test conditions shown in (a) of Figure 3 on page 15 unless otherwise noted.

15. This part has a voltage regulator internally; t_{POWER} is the time that the power needs to be supplied above V_{DD(minimum)} initially, before a read or write operation can be initiated.

16. t_{CHZ}, t_{CLZ}, t_{OELZ}, and t_{OEZH} are specified with AC test conditions shown in part (b) of Figure 3 on page 15. Transition is measured ±200 mV from steady-state voltage.

17. At any voltage and temperature, t_{OEZH} is less than t_{OELZ} and t_{CHZ} is less than t_{CLZ} to eliminate bus contention between SRAMs when sharing the same data bus.

These specifications do not imply a bus contention condition, but reflect parameters guaranteed over worst case user conditions. Device is designed to achieve high Z prior to low Z under the same system conditions.

18. This parameter is sampled and not 100% tested.

Switching Waveforms

Figure 4. Read/Write Waveforms [19, 20, 21]

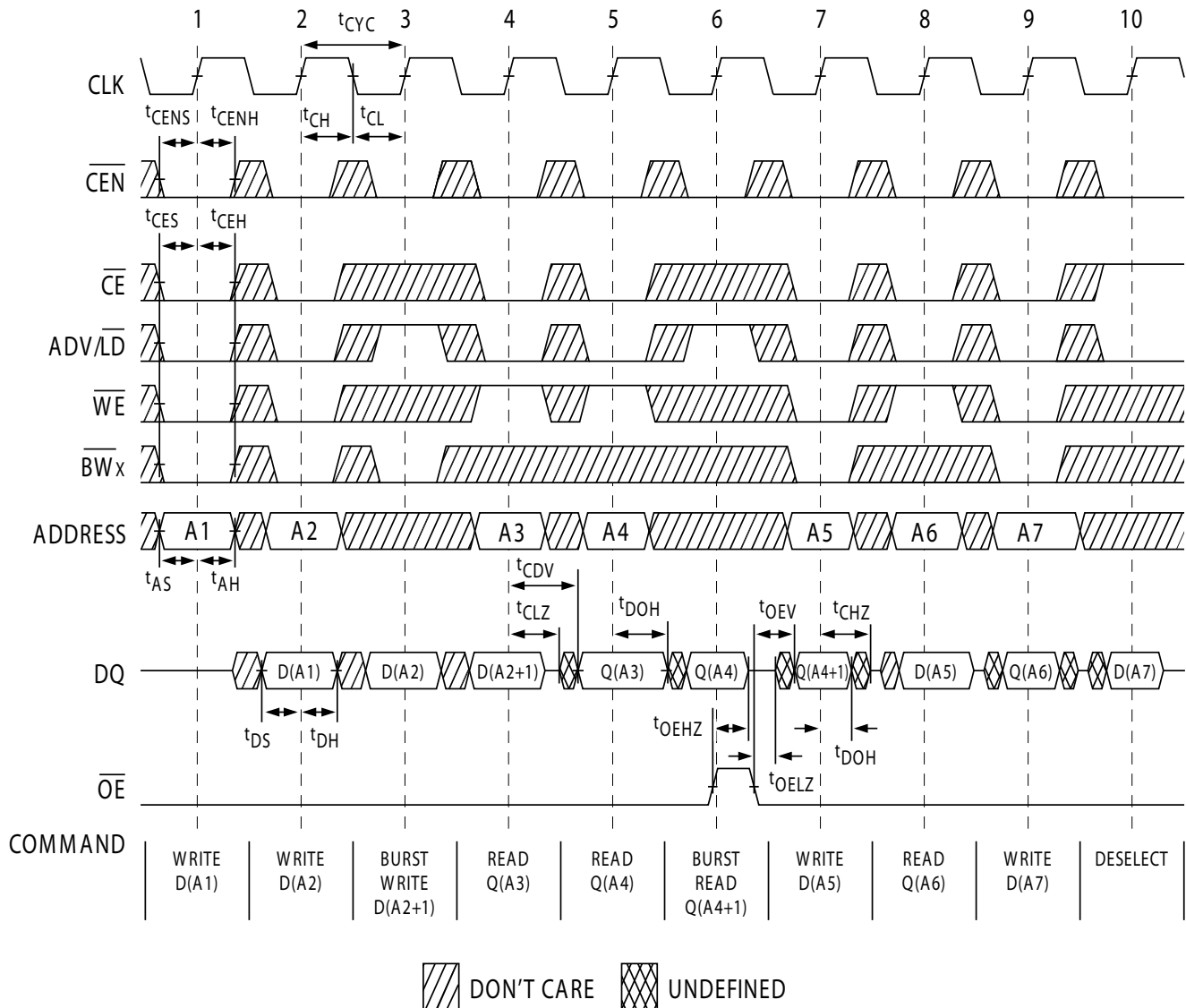

Notes

19. For this waveform ZZ is tied LOW.

20. When \overline{CE} is LOW, \overline{CE}_1 is LOW, \overline{CE}_2 is HIGH and \overline{CE}_3 is LOW. When \overline{CE} is HIGH, \overline{CE}_1 is HIGH or \overline{CE}_2 is LOW or \overline{CE}_3 is HIGH.

21. Order of the burst sequence is determined by the status of the MODE (0 = Linear, 1 = Interleaved). Burst operations are optional.

Switching Waveforms (continued)

Figure 5. NOP, STALL AND DESELECT Cycles [22, 23, 24]

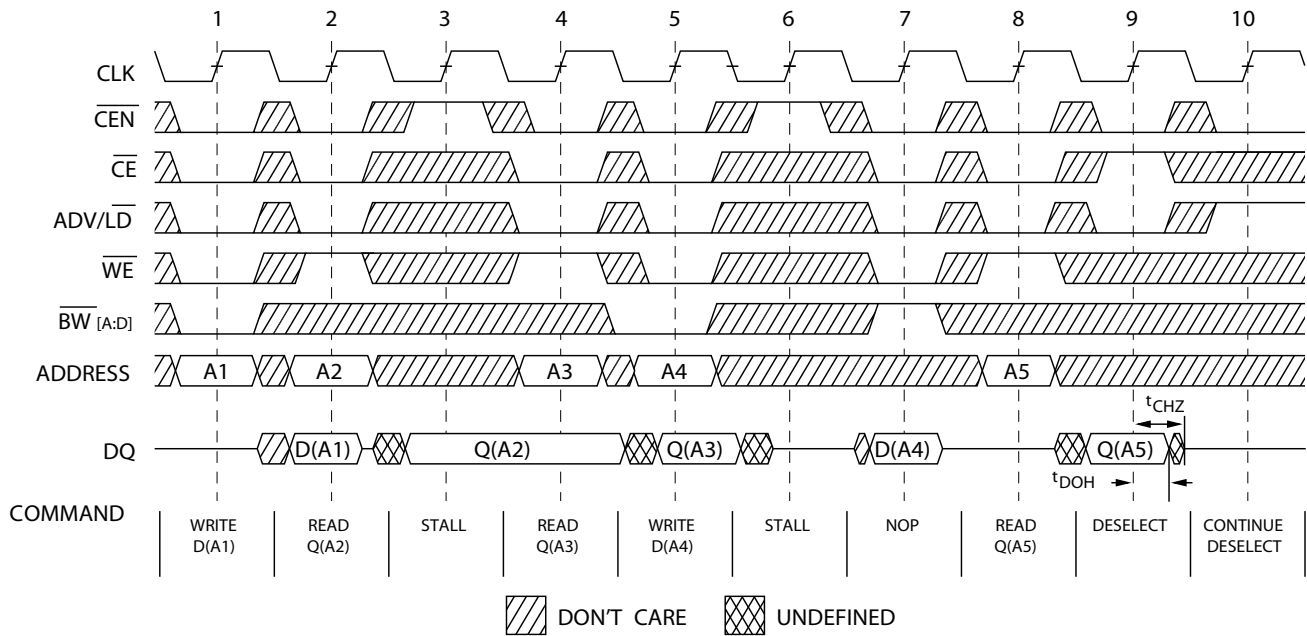

Notes

- 22. For this waveform ZZ is tied LOW.
- 23. When \overline{CE} is LOW, \overline{CE}_1 is LOW, CE_2 is HIGH and \overline{CE}_3 is LOW. When \overline{CE} is HIGH, \overline{CE}_1 is HIGH or CE_2 is LOW or \overline{CE}_3 is HIGH.
- 24. The IGNORE CLOCK EDGE or STALL cycle (Clock 3) illustrates CEN being used to create a pause. A write is not performed during this cycle.

Switching Waveforms (continued)

Figure 6. ZZ Mode Timing [25, 26]

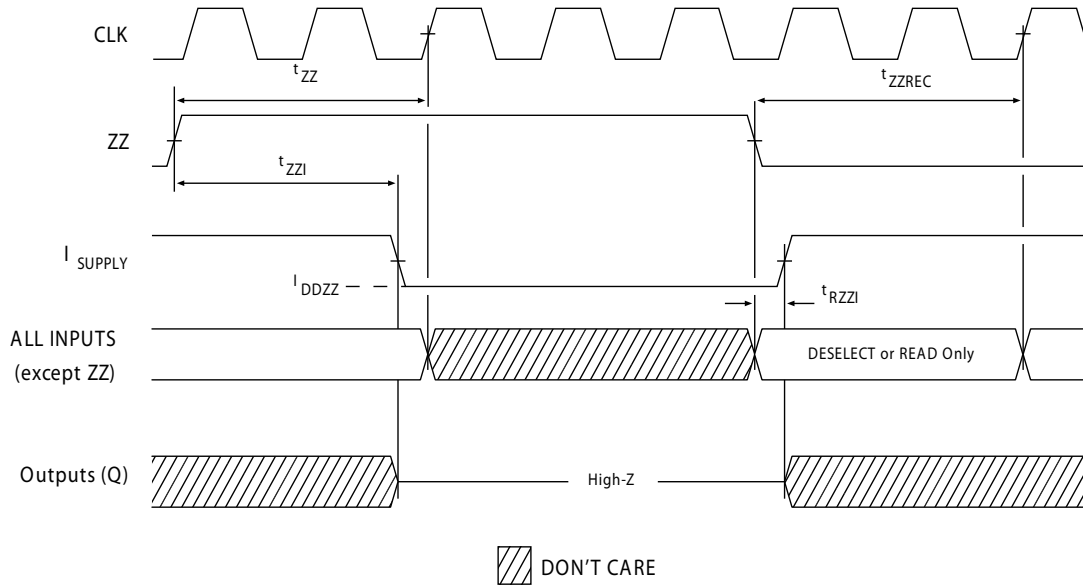

Notes

- 25. Device must be deselected when entering ZZ mode. See truth table for all possible signal conditions to deselect the device.
- 26. DQs are in high Z when exiting ZZ sleep mode.

Ordering Information

Cypress offers other versions of this type of product in many different configurations and features. The below table contains only the list of parts that are currently available. For a complete listing of all options, visit the Cypress website at www.cypress.com and refer to the product summary page at <http://www.cypress.com/products> or contact your local sales representative. Cypress maintains a worldwide network of offices, solution centers, manufacturer's representatives and distributors. To find the office closest to you, visit us at <http://www.cypress.com/go/datasheet/offices>.

Speed (MHz)	Ordering Code	Package Diagram	Part and Package Type	Operating Range
133	CY7C1371KV33-133AXC	51-85050	100-pin TQFP (14 × 20 × 1.4 mm) Pb-free	Commercial
	CY7C1373KV33-133AXI			Industrial
	CY7C1371KVE33-133AXI			
100	CY7C1371KV33-100AXC	51-85050	100-pin TQFP (14 × 20 × 1.4 mm) Pb-free	Commercial
	CY7C1373KV33-100AXC			
	CY7C1371KV33-100AXI			Industrial
	CY7C1371KVE33-100AXI			

Ordering Code Definitions

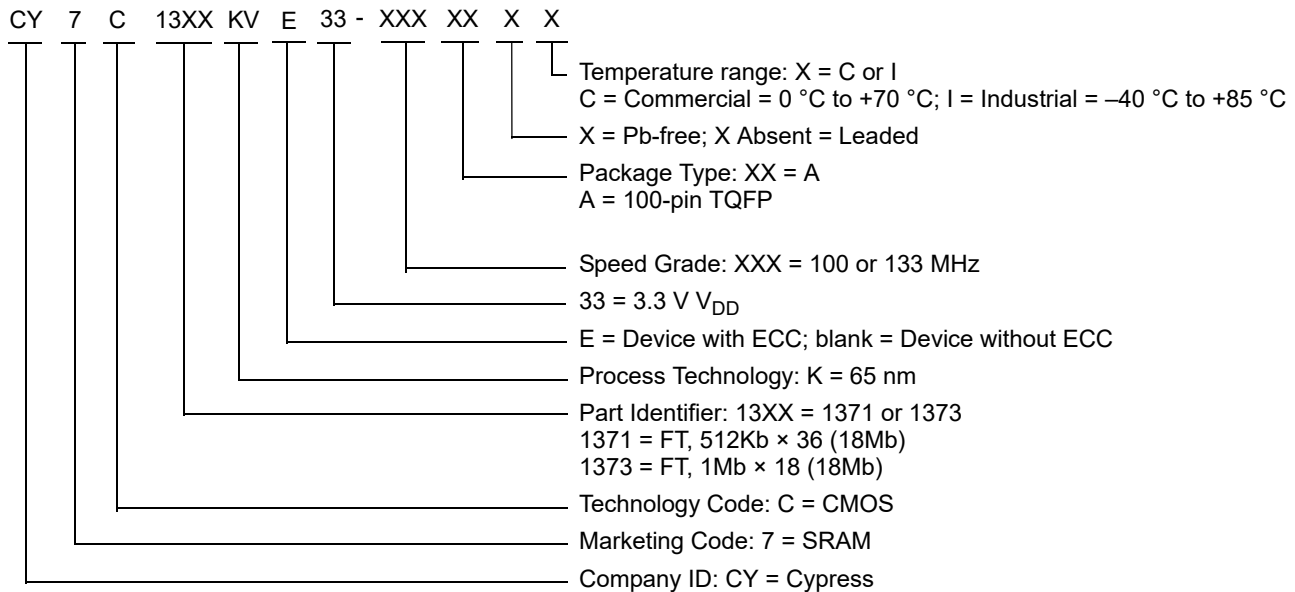

Package Diagrams

Figure 7. 100-pin TQFP (14 × 20 × 1.4 mm) A100RA Package Outline, 51-85050

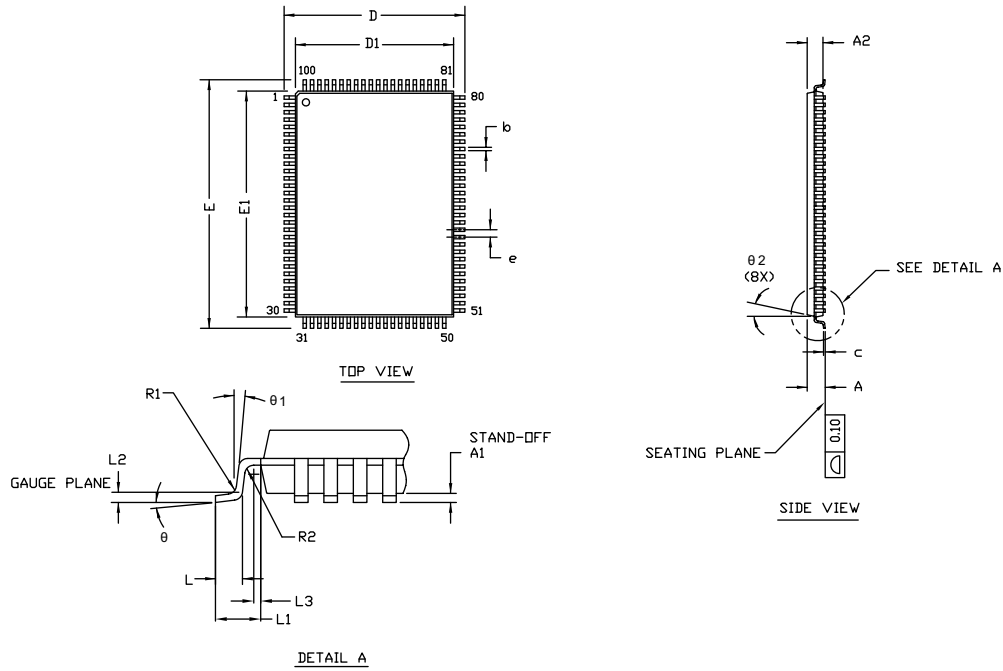

SYMBOL	DIMENSIONS		
	MIN.	NOM.	MAX.
A	—	—	1.60
A1	0.05	—	0.15
A2	1.35	1.40	1.45
D	15.80	16.00	16.20
D1	13.90	14.00	14.10
E	21.80	22.00	22.20
E1	19.90	20.00	20.10
R1	0.08	—	0.20
R2	0.08	—	0.20
θ	0°	—	7°
θ1	0°	—	—
θ2	11°	12°	13°
c	—	—	0.20
b	0.22	0.30	0.38
L	0.45	0.60	0.75
L1	1.00 REF		
L2	0.25 BSC		
L3	0.20	—	—
e	0.65 TYP		

NOTE:
 1. ALL DIMENSIONS ARE IN MILLIMETERS.
 2. BODY LENGTH DIMENSION DOES NOT INCLUDE MOLD PROTRUSION/END FLASH. MOLD PROTRUSION/END FLASH SHALL NOT EXCEED 0.0098 in (0.25 mm) PER SIDE. BODY LENGTH DIMENSIONS ARE MAX PLASTIC BODY SIZE INCLUDING MOLD MISMATCH.
 3. JEDEC SPECIFICATION NO. REF: MS-026.

51-85050 *G

Acronyms

Acronym	Description
CMOS	Complementary Metal Oxide Semiconductor
$\overline{\text{CE}}$	Chip Enable
$\overline{\text{CEN}}$	Clock Enable
EIA	Electronic Industries Alliance
I/O	Input/Output
JEDEC	Joint Electron Devices Engineering Council
JTAG	Joint Test Action Group
LSB	Least Significant Bit
MSB	Most Significant Bit
NoBL	No Bus Latency
$\overline{\text{OE}}$	Output Enable
SRAM	Static Random Access Memory
TAP	Test Access Port
TCK	Test Clock
TDI	Test Data Input
TMS	Test Mode Select
TDO	Test Data Output
TQFP	Thin Quad Flat Pack
TTL	Transistor-Transistor Logic
$\overline{\text{WE}}$	Write Enable

Document Conventions

Units of Measure

Symbol	Unit of Measure
°C	degree Celsius
MHz	megahertz
μA	microampere
mA	milliampere
mm	millimeter
ms	millisecond
mV	millivolt
nm	nanometer
ns	nanosecond
Ω	ohm
%	percent
pF	picofarad
V	volt
W	watt

Document History Page

Document Title: CY7C1371KV33/CY7C1371KVE33/CY7C1373KV33, 18-Mbit (512K × 36/1M × 18) Flow-Through SRAM with NoBL™ Architecture (With ECC) Document Number: 001-97852				
Rev.	ECN No.	Orig. of Change	Submission Date	Description of Change
*C	4983482	DEVM	10/23/2015	Changed status from Preliminary to Final.
*D	5085569	DEVM	01/14/2016	Post to external web.
*E	5333298	PRIT	07/01/2016	Updated Neutron Soft Error Immunity : Updated values in "Typ" and "Max" columns corresponding to LSBU (Device without ECC) parameter. Updated to new template.
*F	6063409	CNX	02/08/2018	Updated Package Diagrams : spec 51-85050 – Changed revision from *E to *G. Updated to new template.

Sales, Solutions, and Legal Information

Worldwide Sales and Design Support

Cypress maintains a worldwide network of offices, solution centers, manufacturer's representatives, and distributors. To find the office closest to you, visit us at [Cypress Locations](#).

Products

Arm® Cortex® Microcontrollers	cypress.com/arm
Automotive	cypress.com/automotive
Clocks & Buffers	cypress.com/clocks
Interface	cypress.com/interface
Internet of Things	cypress.com/iot
Memory	cypress.com/memory
Microcontrollers	cypress.com/mcu
PSoC	cypress.com/psoc
Power Management ICs	cypress.com/pmic
Touch Sensing	cypress.com/touch
USB Controllers	cypress.com/usb
Wireless Connectivity	cypress.com/wireless

PSoC® Solutions

[PSoC 1](#) | [PSoC 3](#) | [PSoC 4](#) | [PSoC 5LP](#) | [PSoC 6 MCU](#)

Cypress Developer Community

[Community](#) | [Projects](#) | [Video](#) | [Blogs](#) | [Training](#) | [Components](#)

Technical Support

cypress.com/support

© Cypress Semiconductor Corporation, 2015-2018. This document is the property of Cypress Semiconductor Corporation and its subsidiaries, including Spansion LLC ("Cypress"). This document, including any software or firmware included or referenced in this document ("Software"), is owned by Cypress under the intellectual property laws and treaties of the United States and other countries worldwide. Cypress reserves all rights under such laws and treaties and does not, except as specifically stated in this paragraph, grant any license under its patents, copyrights, trademarks, or other intellectual property rights. If the Software is not accompanied by a license agreement and you do not otherwise have a written agreement with Cypress governing the use of the Software, then Cypress hereby grants you a personal, non-exclusive, nontransferable license (without the right to sublicense) (1) under its copyright rights in the Software (a) for Software provided in source code form, to modify and reproduce the Software solely for use with Cypress hardware products, only internally within your organization, and (b) to distribute the Software in binary code form externally to end users (either directly or indirectly through resellers and distributors), solely for use on Cypress hardware product units, and (2) under those claims of Cypress's patents that are infringed by the Software (as provided by Cypress, unmodified) to make, use, distribute, and import the Software solely for use with Cypress hardware products. Any other use, reproduction, modification, translation, or compilation of the Software is prohibited.

TO THE EXTENT PERMITTED BY APPLICABLE LAW, CYPRESS MAKES NO WARRANTY OF ANY KIND, EXPRESS OR IMPLIED, WITH REGARD TO THIS DOCUMENT OR ANY SOFTWARE OR ACCOMPANYING HARDWARE, INCLUDING, BUT NOT LIMITED TO, THE IMPLIED WARRANTIES OF MERCHANTABILITY AND FITNESS FOR A PARTICULAR PURPOSE. To the extent permitted by applicable law, Cypress reserves the right to make changes to this document without further notice. Cypress does not assume any liability arising out of the application or use of any product or circuit described in this document. Any information provided in this document, including any sample design information or programming code, is provided only for reference purposes. It is the responsibility of the user of this document to properly design, program, and test the functionality and safety of any application made of this information and any resulting product. Cypress products are not designed, intended, or authorized for use as critical components in systems designed or intended for the operation of weapons, weapons systems, nuclear installations, life-support devices or systems, other medical devices or systems (including resuscitation equipment and surgical implants), pollution control or hazardous substances management, or other uses where the failure of the device or system could cause personal injury, death, or property damage ("Unintended Uses"). A critical component is any component of a device or system whose failure to perform can be reasonably expected to cause the failure of the device or system, or to affect its safety or effectiveness. Cypress is not liable, in whole or in part, and you shall and hereby do release Cypress from any claim, damage, or other liability arising from or related to all Unintended Uses of Cypress products. You shall indemnify and hold Cypress harmless from and against all claims, costs, damages, and other liabilities, including claims for personal injury or death, arising from or related to any Unintended Uses of Cypress products.

Cypress, the Cypress logo, Spansion, the Spansion logo, and combinations thereof, WICED, PSoC, CapSense, EZ-USB, F-RAM, and Traveo are trademarks or registered trademarks of Cypress in the United States and other countries. For a more complete list of Cypress trademarks, visit cypress.com. Other names and brands may be claimed as property of their respective owners.