

# SN74LS259

## 8-Bit Addressable Latch

The SN74LS259 is a high-speed 8-Bit Addressable Latch designed for general purpose storage applications in digital systems. It is a multifunctional device capable of storing single line data in eight addressable latches, and also a 1-of-8 decoder and demultiplexer with active HIGH outputs. The device also incorporates an active LOW common Clear for resetting all latches, as well as, an active LOW Enable.

- Serial-to-Parallel Conversion
- Eight Bits of Storage With Output of Each Bit Available
- Random (Addressable) Data Entry
- Active High Demultiplexing or Decoding Capability
- Easily Expandable
- Common Clear

### GUARANTEED OPERATING RANGES

Symbol	Parameter	Min	Typ	Max	Unit
$V_{CC}$	Supply Voltage	4.75	5.0	5.25	V
$T_A$	Operating Ambient Temperature Range	0	25	70	°C
$I_{OH}$	Output Current - High			-0.4	mA
$I_{OL}$	Output Current - Low			8.0	mA



ON Semiconductor™

<http://onsemi.com>

LOW  
POWER  
SCHOTTKY

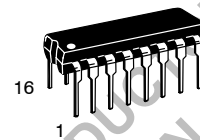

PLASTIC  
N SUFFIX  
CASE 648

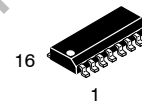

SOIC  
D SUFFIX  
CASE 751B

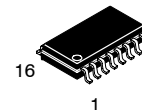

SOEIAJ  
M SUFFIX  
CASE 966

### ORDERING INFORMATION

Device	Package	Shipping
SN74LS259N	16 Pin DIP	2000 Units/Box
SN74LS259D	SOIC-16	38 Units/Rail
SN74LS259DR2	SOIC-16	2500/Tape & Reel
SN74LS259M	SOEIAJ-16	See Note 1
SN74LS259MEL	SOEIAJ-16	See Note 1

1. For ordering information on the EIAJ version of the SOIC package, please contact your local ON Semiconductor representative.

# SN74LS259

## CONNECTION DIAGRAM DIP (TOP VIEW)

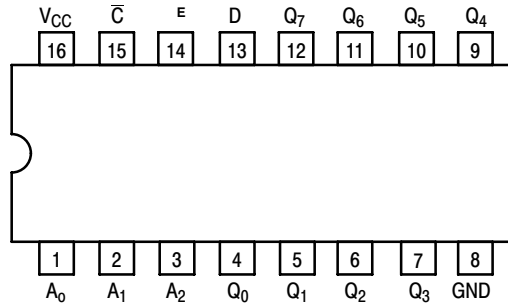

PIN NAMES		LOADING (Note a)	
		HIGH	LOW
A <sub>0</sub> , A <sub>1</sub> , A <sub>2</sub>	Address Inputs	0.5 U.L.	0.25 U.L.
D	Data Input	0.5 U.L.	0.25 U.L.
E	Enable (Active LOW) Input	1.0 U.L.	0.5 U.L.
C̄	Clear (Active LOW) Input	0.5 U.L.	0.25 U.L.
Q <sub>0</sub> - Q <sub>7</sub>	Parallel Latch Outputs	10 U.L.	5 U.L.

### NOTES:

a) 1 TTL Unit Load (U.L.) = 40  $\mu$ A HIGH/1.6 mA LOW.

OBSOLETE

THIS DEVICE IS OBSOLETE  
PLEASE CONTACT YOUR ON SEMICONDUCTOR  
REPRESENTATIVE FOR INFORMATION

# SN74LS259

## LOGIC DIAGRAM

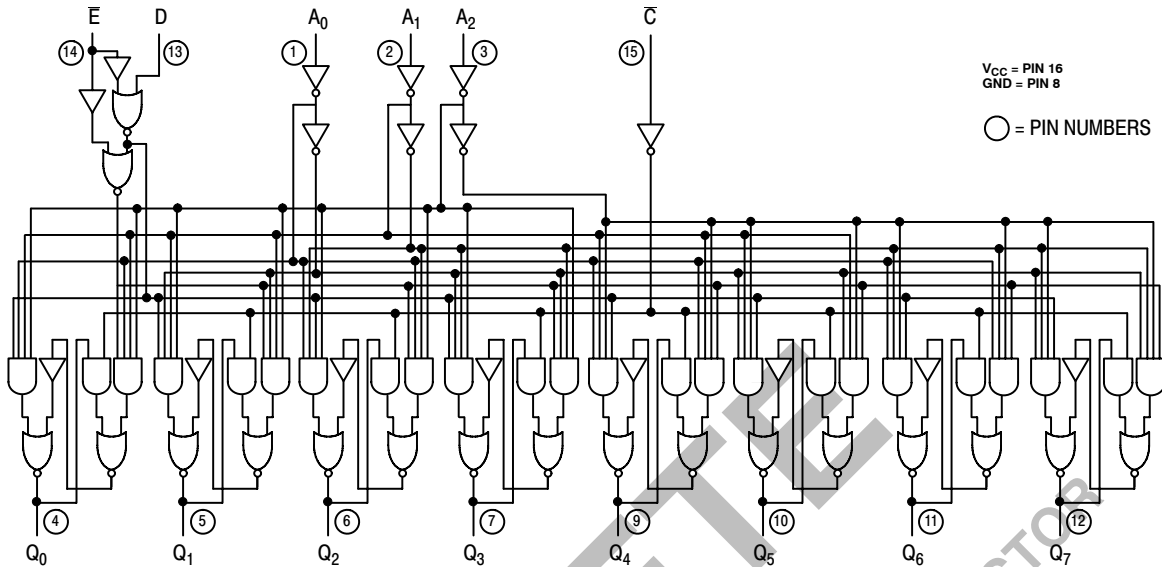

V<sub>CC</sub> = PIN 16  
GND = PIN 8

○ = PIN NUMBERS

### FUNCTIONAL DESCRIPTION

The SN74LS259 has four modes of operation as shown in the mode selection table. In the addressable latch mode, data on the Data line (D) is written into the addressed latch. The addressed latch will follow the data input with all non-addressed latches remaining in their previous states. In the memory mode, all latches remain in their previous state and are unaffected by the Data or Address inputs.

In the one-of-eight decoding or demultiplexing mode, the addressed output will follow the state of the D input with all

other inputs in the LOW state. In the clear mode all outputs are LOW and unaffected by the address and data inputs.

When operating the SN74LS259 as an addressable latch, changing more than one bit of the address could impose a transient wrong address. Therefore, this should only be done while in the memory mode.

The truth table below summarizes the operations.

### TRUTH TABLE

#### PRESENT OUTPUT STATES

MODE SELECTION			PRESENT OUTPUT STATES															
E	C̄	MODE	C̄	Ē	D	A <sub>0</sub>	A <sub>1</sub>	A <sub>2</sub>	Q <sub>0</sub>	Q <sub>1</sub>	Q <sub>2</sub>	Q <sub>3</sub>	Q <sub>4</sub>	Q <sub>5</sub>	Q <sub>6</sub>	Q <sub>7</sub>	MODE	
L	H	Addressable Latch	L	H	X	X	X	X	L	L	L	L	L	L	L	L	L	Clear Demultiplex
L	L		L	L	L	L	L	L	L	L	L	L	L	L	L	L	L	
H	H		L	L	H	L	L	L	H	L	L	L	L	L	L	L	L	
L	L		L	L	L	H	L	L	L	L	L	L	L	L	L	L	L	
L	L	Active HIGH Eight-Channel Demultiplexer	L	L	L	H	L	L	L	L	L	L	L	L	L	L	L	Memory
L	L		L	L	H	H	L	L	L	H	L	L	L	L	L	L	L	
L	L		L	L	H	H	H	L	L	L	L	L	L	L	L	L	L	
L	L		L	L	H	H	H	H	L	L	L	L	L	L	L	L	L	
H	L	Clear	L	L	H	H	H	H	L	L	L	L	L	L	L	L	H	Addressable Latch
H	L		L	L	X	X	X	X	Q <sub>N-1</sub>	Q <sub>N-1</sub>	Q <sub>N-1</sub>	Q <sub>N-1</sub>	Q <sub>N-1</sub>	Q <sub>N-1</sub>	Q <sub>N-1</sub>	Q <sub>N-1</sub>	Q <sub>N-1</sub>	
H	L		L	L	L	L	L	L	L	Q <sub>N-1</sub>	Q <sub>N-1</sub>	Q <sub>N-1</sub>	Q <sub>N-1</sub>	Q <sub>N-1</sub>	Q <sub>N-1</sub>	Q <sub>N-1</sub>	Q <sub>N-1</sub>	
H	L		L	L	L	L	L	L	L	Q <sub>N-1</sub>	Q <sub>N-1</sub>	Q <sub>N-1</sub>	Q <sub>N-1</sub>	Q <sub>N-1</sub>	Q <sub>N-1</sub>	Q <sub>N-1</sub>	Q <sub>N-1</sub>	
H	L	Memory	L	L	L	L	L	L	Q <sub>N-1</sub>	Q <sub>N-1</sub>	Q <sub>N-1</sub>	Q <sub>N-1</sub>	Q <sub>N-1</sub>	Q <sub>N-1</sub>	Q <sub>N-1</sub>	Q <sub>N-1</sub>	Q <sub>N-1</sub>	Addressable Latch
H	L		L	L	L	L	L	L	Q <sub>N-1</sub>	Q <sub>N-1</sub>	Q <sub>N-1</sub>	Q <sub>N-1</sub>	Q <sub>N-1</sub>	Q <sub>N-1</sub>	Q <sub>N-1</sub>	Q <sub>N-1</sub>	Q <sub>N-1</sub>	
H	L		L	L	L	L	L	L	Q <sub>N-1</sub>	Q <sub>N-1</sub>	Q <sub>N-1</sub>	Q <sub>N-1</sub>	Q <sub>N-1</sub>	Q <sub>N-1</sub>	Q <sub>N-1</sub>	Q <sub>N-1</sub>	Q <sub>N-1</sub>	
H	L		L	L	L	L	L	L	Q <sub>N-1</sub>	Q <sub>N-1</sub>	Q <sub>N-1</sub>	Q <sub>N-1</sub>	Q <sub>N-1</sub>	Q <sub>N-1</sub>	Q <sub>N-1</sub>	Q <sub>N-1</sub>	Q <sub>N-1</sub>	
H	L	Clear	L	L	L	L	L	L	Q <sub>N-1</sub>	Q <sub>N-1</sub>	Q <sub>N-1</sub>	Q <sub>N-1</sub>	Q <sub>N-1</sub>	Q <sub>N-1</sub>	Q <sub>N-1</sub>	Q <sub>N-1</sub>	Q <sub>N-1</sub>	Addressable Latch
H	L		L	L	L	L	L	L	Q <sub>N-1</sub>	Q <sub>N-1</sub>	Q <sub>N-1</sub>	Q <sub>N-1</sub>	Q <sub>N-1</sub>	Q <sub>N-1</sub>	Q <sub>N-1</sub>	Q <sub>N-1</sub>	Q <sub>N-1</sub>	
H	L		L	L	L	L	L	L	Q <sub>N-1</sub>	Q <sub>N-1</sub>	Q <sub>N-1</sub>	Q <sub>N-1</sub>	Q <sub>N-1</sub>	Q <sub>N-1</sub>	Q <sub>N-1</sub>	Q <sub>N-1</sub>	Q <sub>N-1</sub>	
H	L		L	L	L	L	L	L	Q <sub>N-1</sub>	Q <sub>N-1</sub>	Q <sub>N-1</sub>	Q <sub>N-1</sub>	Q <sub>N-1</sub>	Q <sub>N-1</sub>	Q <sub>N-1</sub>	Q <sub>N-1</sub>	Q <sub>N-1</sub>	

X = Don't Care Condition  
L = LOW Voltage Level  
H = HIGH Voltage Level  
Q<sub>N-1</sub> = Previous Output State

# SN74LS259

## DC CHARACTERISTICS OVER OPERATING TEMPERATURE RANGE (unless otherwise specified)

Symbol	Parameter	Limits			Unit	Test Conditions
		Min	Typ	Max		
V <sub>IH</sub>	Input HIGH Voltage	2.0			V	Guaranteed Input HIGH Voltage for All Inputs
V <sub>IL</sub>	Input LOW Voltage			0.8	V	Guaranteed Input LOW Voltage for All Inputs
V <sub>IK</sub>	Input Clamp Diode Voltage		-0.65	-1.5	V	V <sub>CC</sub> = MIN, I <sub>IN</sub> = -18 mA
V <sub>OH</sub>	Output HIGH Voltage	2.7	3.5		V	V <sub>CC</sub> = MIN, I <sub>OH</sub> = MAX, V <sub>IN</sub> = V <sub>IH</sub> or V <sub>IL</sub> per Truth Table
V <sub>OL</sub>	Output LOW Voltage		0.25	0.4	V	I <sub>OL</sub> = 4.0 mA I <sub>OL</sub> = 8.0 mA
			0.35	0.5	V	
I <sub>IH</sub>	Input HIGH Current			20	μA	V <sub>CC</sub> = MAX, V <sub>IN</sub> = 2.7 V
				0.1	mA	V <sub>CC</sub> = MAX, V <sub>IN</sub> = 7.0 V
I <sub>IL</sub>	Input LOW Current			-0.4	mA	V <sub>CC</sub> = MAX, V <sub>IN</sub> = 0.4 V
I <sub>OS</sub>	Short Circuit Current (Note 2)	-20		-100	mA	V <sub>CC</sub> = MAX
I <sub>CC</sub>	Power Supply Current			36	mA	V <sub>CC</sub> = MAX

2. Not more than one output should be shorted at a time, nor for more than 1 second.

## AC CHARACTERISTICS (T<sub>A</sub> = 25°C, V<sub>CC</sub> = 5.0 V)

Symbol	Parameter	Limits			Unit	Test Conditions
		Min	Typ	Max		
t <sub>PLH</sub> t <sub>PHL</sub>	Turn-Off Delay, Enable to Output Turn-On Delay, Enable to Output		22 15	35 24	ns ns	C <sub>L</sub> = 15 pF
t <sub>PLH</sub> t <sub>PHL</sub>	Turn-Off Delay, Data to Output Turn-On Delay, Data to Output		20 13	32 21	ns ns	
t <sub>PLH</sub> t <sub>PHL</sub>	Turn-Off Delay, Address to Output Turn-On Delay, Address to Output		24 18	38 29	ns ns	
t <sub>PHL</sub>	Turn-On Delay, Clear to Output		17	27	ns	

## AC SET-UP REQUIREMENTS (T<sub>A</sub> = 25°C, V<sub>CC</sub> = 5.0 V)

Symbol	Parameter	Limits			Unit
		Min	Typ	Max	
t <sub>s</sub>	Input Setup Time	20			ns
t <sub>w</sub>	Pulse Width, Clear or Enable	15			ns
t <sub>h</sub>	Hold Time, Data	5.0			ns
t <sub>h</sub>	Hold Time, Address	20			ns

AC WAVEFORMS

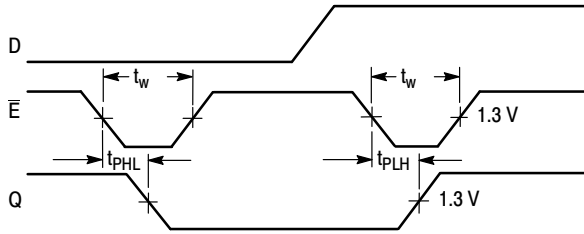

OTHER CONDITIONS:  $\bar{C} = H, A = \text{STABLE}$

Figure 1. Turn-on and Turn-off Delays, Enable To Output and Enable Pulse Width

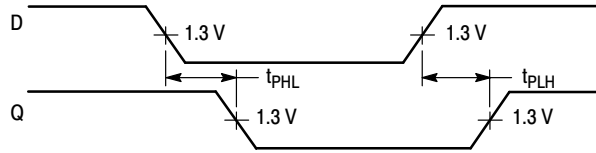

OTHER CONDITIONS:  $\bar{E} = L, \bar{C} = H, A = \text{STABLE}$

Figure 2. Turn-on and Turn-off Delays, Data to Output

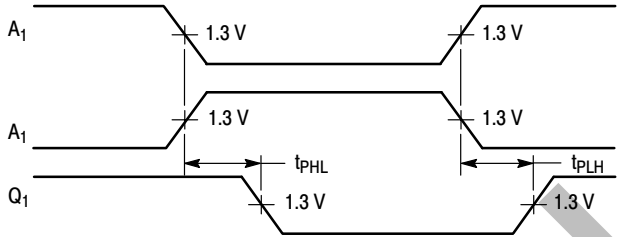

OTHER CONDITIONS:  $\bar{E} = L, \bar{C} = L, D = H$

Figure 3. Turn-on and Turn-off Delays, Address to Output

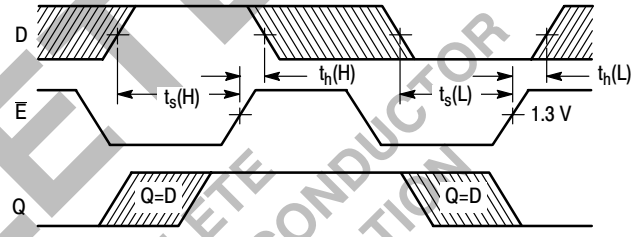

OTHER CONDITIONS:  $\bar{C} = H, A = \text{STABLE}$

Figure 4. Setup and Hold Time, Data to Enable

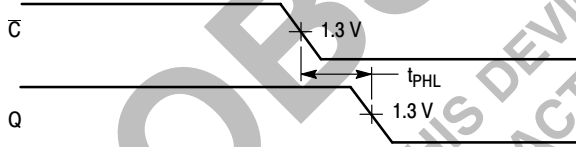

OTHER CONDITIONS:  $\bar{E} = H$

Figure 5. Turn-on Delay, Clear to Output

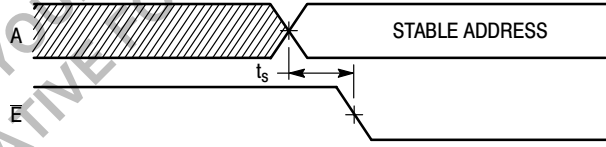

OTHER CONDITIONS:  $\bar{C} = H$

Figure 6. Setup Time, Address to Enable (See Notes 1 and 2)

NOTES:

1. The Address to Enable Setup Time is the time before the HIGH-to-LOW Enable transition that the Address must be stable so that the correct latch is addressed and the other latches are not affected.
2. The shaded areas indicate when the inputs are permitted to change for predictable output performance.

# SN74LS259

## PACKAGE DIMENSIONS

N SUFFIX  
 PLASTIC PACKAGE  
 CASE 648-08  
 ISSUE R

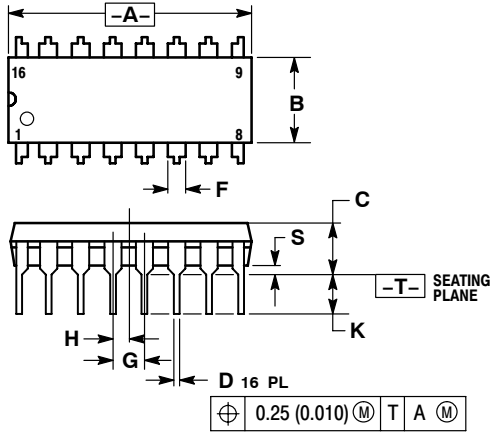

NOTES:

1. DIMENSIONING AND TOLERANCING PER ANSI Y14.5M, 1982.
2. CONTROLLING DIMENSION: INCH.
3. DIMENSION L TO CENTER OF LEADS WHEN FORMED PARALLEL.
4. DIMENSION B DOES NOT INCLUDE MOLD FLASH.
5. ROUNDED CORNERS OPTIONAL.

DIM	INCHES		MILLIMETERS	
	MIN	MAX	MIN	MAX
A	0.740	0.770	18.80	19.55
B	0.250	0.270	6.35	6.85
C	0.145	0.175	3.69	4.44
D	0.015	0.021	0.39	0.53
F	0.040	0.70	1.02	1.77
G	0.100 BSC		2.54 BSC	
H	0.050 BSC		1.27 BSC	
J	0.008	0.015	0.21	0.38
K	0.110	0.130	2.80	3.30
L	0.295	0.305	7.50	7.74
M	0°	10°	0°	10°
S	0.020	0.040	0.51	1.01

OBSOLETE

THIS DEVICE IS OBSOLETE  
 PLEASE CONTACT YOUR ON SEMICONDUCTOR  
 REPRESENTATIVE FOR INFORMATION

# SN74LS259

## PACKAGE DIMENSIONS

**D SUFFIX**  
 PLASTIC SOIC PACKAGE  
 CASE 751B-05  
 ISSUE J

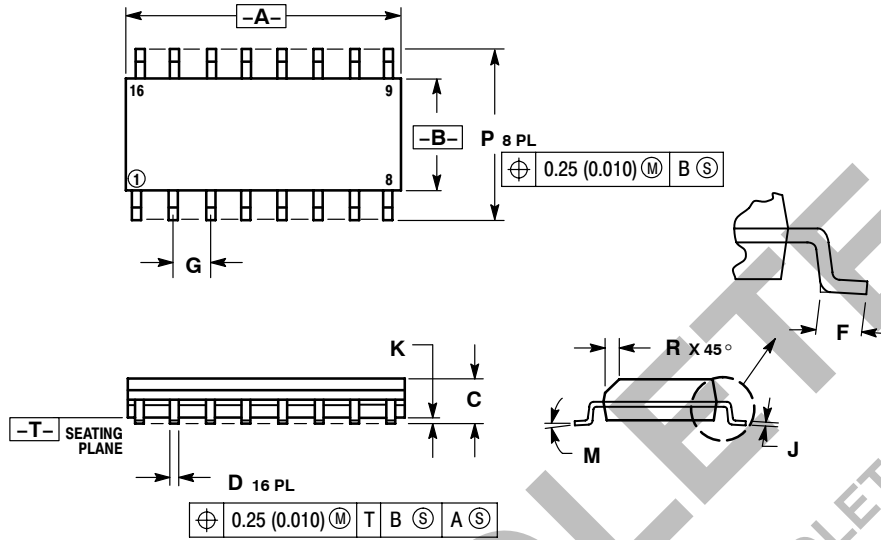

- NOTES:
1. DIMENSIONING AND TOLERANCING PER ANSI Y14.5M, 1982.
  2. CONTROLLING DIMENSION: MILLIMETER.
  3. DIMENSIONS A AND B DO NOT INCLUDE MOLD PROTRUSION.
  4. MAXIMUM MOLD PROTRUSION 0.15 (0.006) PER SIDE.
  5. DIMENSION D DOES NOT INCLUDE DAMBAR PROTRUSION. ALLOWABLE DAMBAR PROTRUSION SHALL BE 0.127 (0.005) TOTAL IN EXCESS OF THE D DIMENSION AT MAXIMUM MATERIAL CONDITION.

DIM	MILLIMETERS		INCHES	
	MIN	MAX	MIN	MAX
A	9.80	10.00	0.386	0.393
B	3.80	4.00	0.150	0.157
C	1.35	1.75	0.054	0.068
D	0.35	0.49	0.014	0.019
F	0.40	1.25	0.016	0.049
G	1.27 BSC		0.050 BSC	
J	0.19	0.25	0.008	0.009
K	0.10	0.25	0.004	0.009
M	0°		7°	
P	5.80	6.20	0.229	0.244
R	0.25	0.50	0.010	0.019

OBSOLETE

THIS DEVICE IS OBSOLETE  
 PLEASE CONTACT YOUR ON SEMICONDUCTOR  
 REPRESENTATIVE FOR INFORMATION

# SN74LS259

## PACKAGE DIMENSIONS

M SUFFIX  
SOEIAJ PACKAGE  
CASE 966-01  
ISSUE O

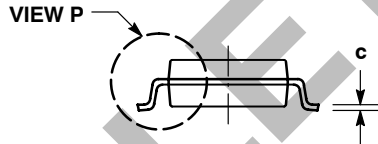
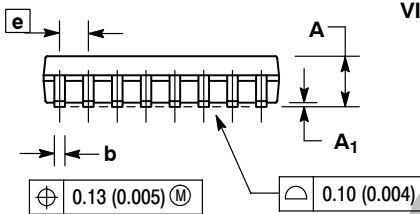
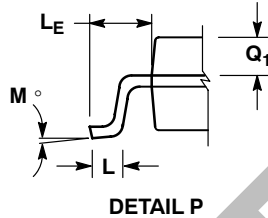
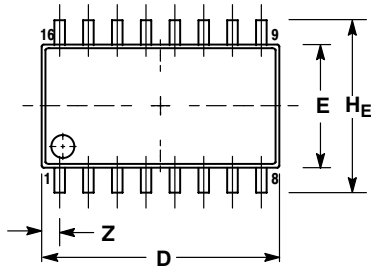

NOTES:

1. DIMENSIONING AND TOLERANCING PER ANSI Y14.5M, 1982.
2. CONTROLLING DIMENSION: MILLIMETER.
3. DIMENSIONS D AND E DO NOT INCLUDE MOLD FLASH OR PROTRUSIONS AND ARE MEASURED AT THE PARTING LINE. MOLD FLASH OR PROTRUSIONS SHALL NOT EXCEED 0.15 (0.006) PER SIDE.
4. TERMINAL NUMBERS ARE SHOWN FOR REFERENCE ONLY.
5. THE LEAD WIDTH DIMENSION (b) DOES NOT INCLUDE DAMBAR PROTRUSION. ALLOWABLE DAMBAR PROTRUSION SHALL BE 0.08 (0.003) TOTAL IN EXCESS OF THE LEAD WIDTH DIMENSION AT MAXIMUM MATERIAL CONDITION. DAMBAR CANNOT BE LOCATED ON THE LOWER RADIUS OR THE FOOT. MINIMUM SPACE BETWEEN PROTRUSIONS AND ADJACENT LEAD TO BE 0.46 (0.018).

DIM	MILLIMETERS		INCHES	
	MIN	MAX	MIN	MAX
A	---	2.05	---	0.081
A <sub>1</sub>	0.05	0.20	0.002	0.008
b	0.35	0.50	0.014	0.020
c	0.18	0.27	0.007	0.011
D	9.90	10.50	0.390	0.413
E	5.10	5.45	0.201	0.215
e	1.27 BSC		0.050 BSC	
HE	7.40	8.20	0.291	0.323
L	0.50	0.85	0.020	0.033
LE	1.10	1.50	0.043	0.059
M	0° 10°		0° 10°	
Q <sub>1</sub>	0.70	0.90	0.028	0.035
Z	---	0.78	---	0.031

ON Semiconductor and are registered trademarks of Semiconductor Components Industries, LLC (SCILLC). SCILLC reserves the right to make changes without further notice to any products herein. SCILLC makes no warranty, representation or guarantee regarding the suitability of its products for any particular purpose, nor does SCILLC assume any liability arising out of the application or use of any product or circuit, and specifically disclaims any and all liability, including without limitation special, consequential or incidental damages. "Typical" parameters which may be provided in SCILLC data sheets and/or specifications can and do vary in different applications and actual performance may vary over time. All operating parameters, including "Typicals" must be validated for each customer application by customer's technical experts. SCILLC does not convey any license under its patent rights nor the rights of others. SCILLC products are not designed, intended, or authorized for use as components in systems intended for surgical implant into the body, or other applications intended to support or sustain life, or for any other application in which the failure of the SCILLC product could create a situation where personal injury or death may occur. Should Buyer purchase or use SCILLC products for any such unintended or unauthorized application, Buyer shall indemnify and hold SCILLC and its officers, employees, subsidiaries, affiliates, and distributors harmless against all claims, costs, damages, and expenses, and reasonable attorney fees arising out of, directly or indirectly, any claim of personal injury or death associated with such unintended or unauthorized use, even if such claim alleges that SCILLC was negligent regarding the design or manufacture of the part. SCILLC is an Equal Opportunity/Affirmative Action Employer. This literature is subject to all applicable copyright laws and is not for resale in any manner.

### PUBLICATION ORDERING INFORMATION

**LITERATURE FULFILLMENT:**

Literature Distribution Center for ON Semiconductor  
P.O. Box 5163, Denver, Colorado 80217 USA  
Phone: 303-675-2175 or 800-344-3860 Toll Free USA/Canada  
Fax: 303-675-2176 or 800-344-3867 Toll Free USA/Canada  
Email: orderlit@onsemi.com

**N. American Technical Support:** 800-282-9855 Toll Free  
USA/Canada  
**Europe, Middle East and Africa Technical Support:**  
Phone: 421 33 790 2910  
**Japan Customer Focus Center**  
Phone: 81-3-5773-3850

**ON Semiconductor Website:** [www.onsemi.com](http://www.onsemi.com)

**Order Literature:** <http://www.onsemi.com/orderlit>

For additional information, please contact your local Sales Representative

SN74LS259/D