

N-Channel 200 V (D-S) 175 °C MOSFET

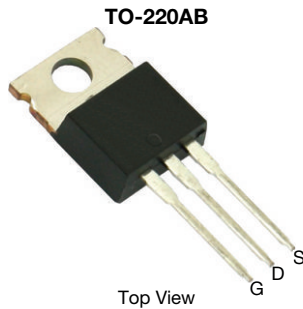

FEATURES

- ThunderFET® power MOSFET
- Low R_{DS} - Q_g figure-of-merit (FOM)
- Maximum 175 °C junction temperature
- 100 % R_g and UIS tested
- Material categorization:
for definitions of compliance please see www.vishay.com/doc?99912



RoHS
COMPLIANT
HALOGEN
FREE

APPLICATIONS

- Synchronous rectification
- Power supplies
- DC/AC inverter
- DC/DC converter
- Solar micro inverter
- Motor drive switch

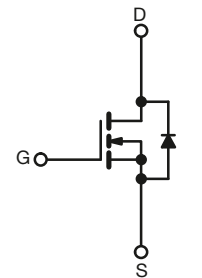

N-Channel MOSFET

PRODUCT SUMMARY

V_{DS} (V)	200
$R_{DS(on)}$ max. (Ω) at $V_{GS} = 10$ V	0.0216
$R_{DS(on)}$ max. (Ω) at $V_{GS} = 7.5$ V	0.0235
Q_g typ. (nC)	31.6
I_D (A)	64
Configuration	Single

ORDERING INFORMATION

Package	TO-220AB
Lead (Pb)-free and halogen-free	SUP90220E-GE3

ABSOLUTE MAXIMUM RATINGS ($T_A = 25$ °C, unless otherwise noted)

PARAMETER	SYMBOL	LIMIT	UNIT
Drain-source voltage	V_{DS}	200	V
Gate-source voltage	V_{GS}	± 20	
Continuous drain current	I_D	$T_C = 25$ °C	64
		$T_C = 125$ °C	37
Pulsed drain current ($t = 100$ μ s)	I_{DM}	100	A
Continuous source-drain diode current	I_S	64.7	
Single pulse avalanche current ^a	I_{AS}	45	mJ
Single pulse avalanche energy ^a			
Maximum power dissipation	P_D	$T_C = 25$ °C	230 ^b
		$T_C = 125$ °C	77 ^b
Operating junction and storage temperature range	T_J, T_{stg}	-55 to +175	°C
Soldering recommendations (peak temperature) ^c		260	

THERMAL RESISTANCE RATINGS

PARAMETER	SYMBOL	MAXIMUM	UNIT
Maximum junction-to-ambient (PCB mount) ^c	R_{thJA}	40	°C/W
Maximum junction-to-case (drain)	R_{thJC}	0.65	

Notes

- Duty cycle ≤ 1 %.
- See SOA curve for voltage derating.
- When mounted on 1" square PCB (FR4 material).



SPECIFICATIONS (T _J = 25 °C, unless otherwise noted)						
PARAMETER	SYMBOL	TEST CONDITIONS	MIN.	TYP.	MAX.	UNIT
Static						
Drain-source breakdown voltage	V _{DS}	V _{GS} = 0 V, I _D = 250 μA	200	-	-	V
Gate-source threshold voltage	V _{GS(th)}	V _{DS} = V _{GS} , I _D = 250 μA	2	-	4	V
Gate-source leakage	I _{GSS}	V _{DS} = 0 V, V _{GS} = ± 20 V	-	-	250	nA
Zero gate voltage drain current	I _{DSS}	V _{DS} = 200 V, V _{GS} = 0 V	-	-	1	μA
		V _{DS} = 200 V, V _{GS} = 0 V, T _J = 125 °C	-	-	150	
		V _{DS} = 200 V, V _{GS} = 0 V, T _J = 175 °C	-	-	5	mA
On-state drain current ^a	I _{D(on)}	V _{DS} ≥ 10 V, V _{GS} = 10 V	30	-	-	A
Drain-source on-state resistance ^a	R _{DS(on)}	V _{GS} = 10 V, I _D = 15 A	-	0.0180	0.0216	Ω
		V _{GS} = 7.5 V, I _D = 10 A	-	0.0188	0.0235	
Forward transconductance ^a	g _{fs}	V _{DS} = 15 V, I _D = 15 A	-	37	-	S
Dynamic ^b						
Input capacitance	C _{iss}	V _{DS} = 100 V, V _{GS} = 0 V, f = 1 MHz	-	1950	-	pF
Output capacitance	C _{oss}		-	170	-	
Reverse transfer capacitance	C _{rss}		-	15	-	
Total gate charge	Q _g	V _{DS} = 100 V, V _{GS} = 10 V, I _D = 15 A	-	31.6	48	nC
Gate-source charge	Q _{gs}		-	8.6	-	
Gate-drain charge	Q _{gd}		-	7.6	-	
Gate resistance	R _g	f = 1 MHz	0.6	3	6	Ω
Turn-on delay time	t _{d(on)}	V _{DD} = 100 V, R _L = 8.3 Ω, I _D ≅ 12 A, V _{GEN} = 10 V, R _g = 1 Ω	-	15	30	ns
Rise time	t _r		-	35	53	
Turn-off delay time	t _{d(off)}		-	28	42	
Fall time	t _f		-	38	57	
Drain-Source Body Diode Characteristics						
Pulse diode forward current (t = 100 μs)	I _{SM}		-	-	100	A
Body diode voltage	V _{SD}	I _F = 12 A, V _{GS} = 0 V	-	0.85	1.5	V
Body diode reverse recovery time	t _{rr}	I _F = 12 A, di/dt = 100 A/μs	-	120	180	ns
Body diode reverse recovery charge	Q _{rr}		-	0.91	1.37	μC
Reverse recovery fall time	t _a		-	95	-	ns
Reverse recovery rise time	t _b		-	25	-	
Body diode peak reverse recovery charge	I _{RM(REC)}		-	-	12	18

Notes

- Pulse test; pulse width ≤ 300 μs, duty cycle ≤ 2 %.
- Guaranteed by design, not subject to production testing.
- Independent of operating temperature.

Stresses beyond those listed under "Absolute Maximum Ratings" may cause permanent damage to the device. These are stress ratings only, and functional operation of the device at these or any other conditions beyond those indicated in the operational sections of the specifications is not implied. Exposure to absolute maximum rating conditions for extended periods may affect device reliability.

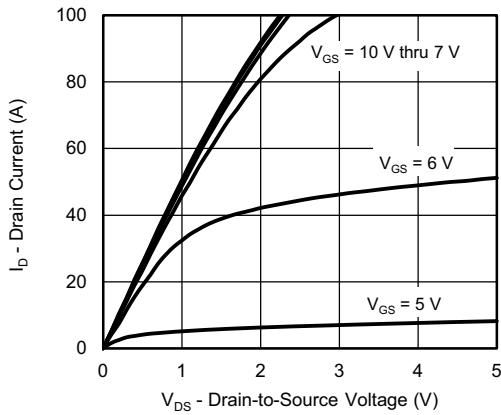
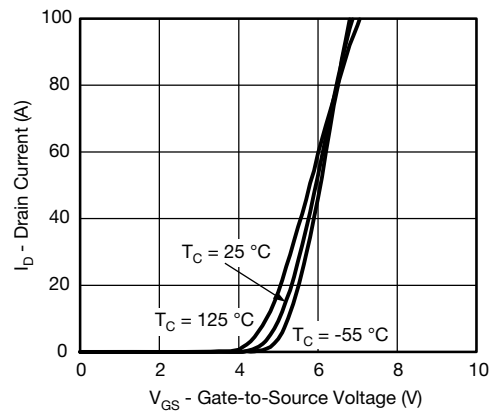
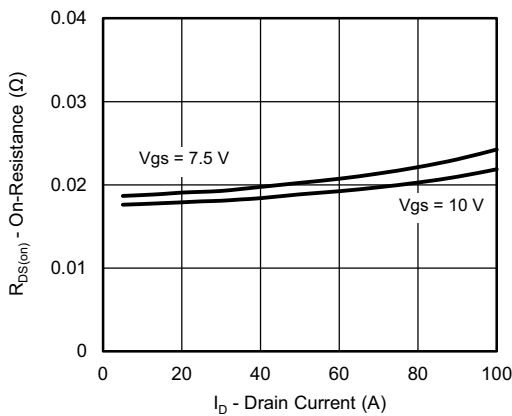
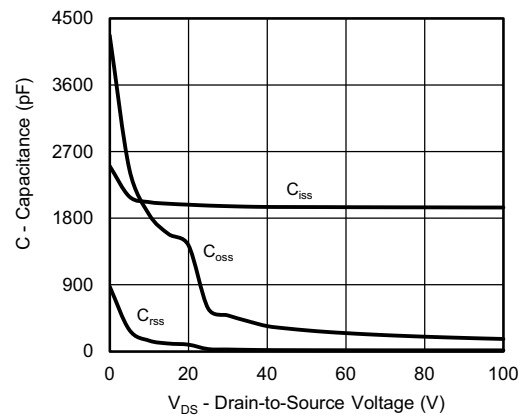
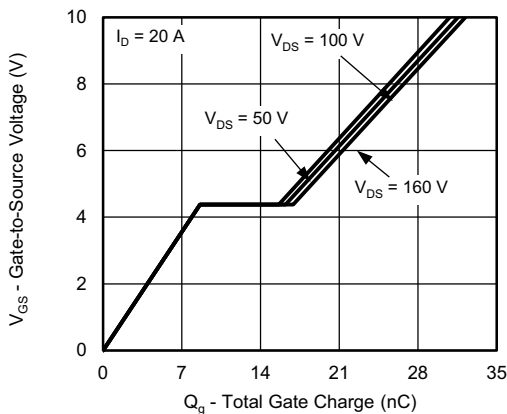
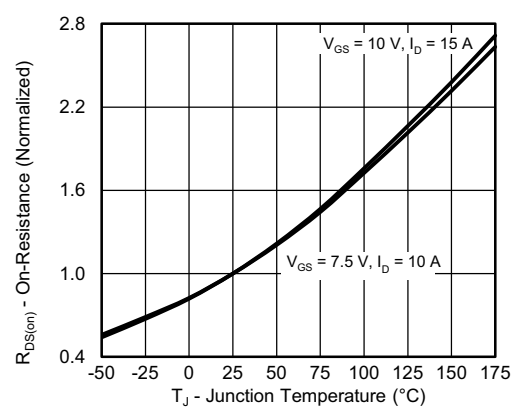
TYPICAL CHARACTERISTICS (25 °C, unless otherwise noted)

Output Characteristics

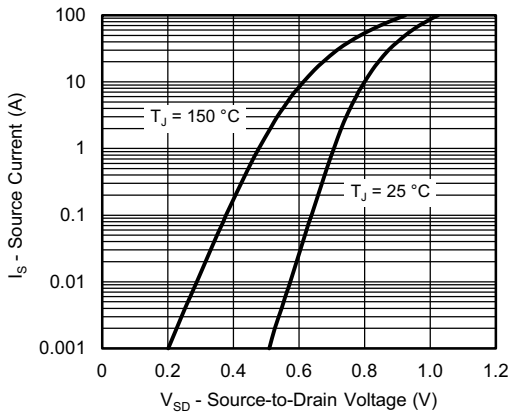
Transfer Characteristics

On-Resistance vs. Drain Current and Gate Voltage

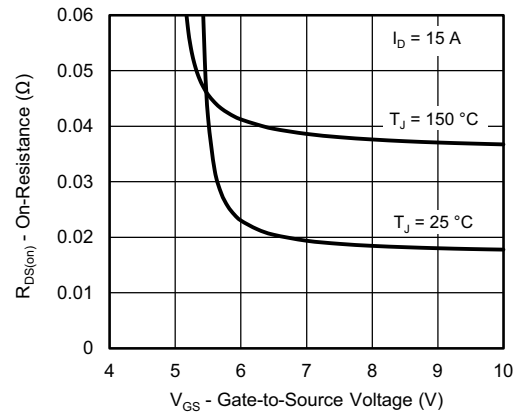
Capacitance

Gate Charge

On-Resistance vs. Junction Temperature

TYPICAL CHARACTERISTICS (25 °C, unless otherwise noted)



Source-Drain Diode Forward Voltage



On-Resistance vs. Gate-to-Source Voltage

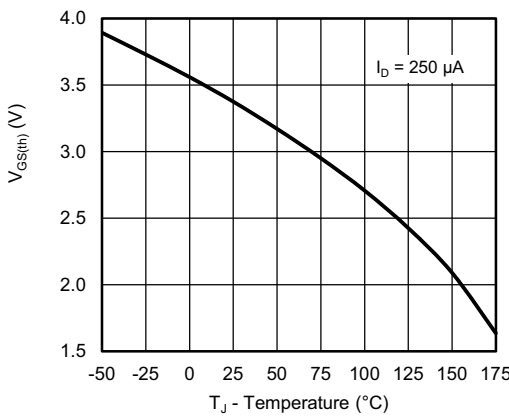

Threshold Voltage

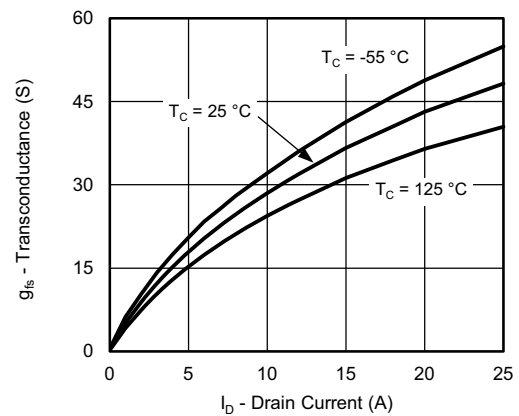

Transconductance

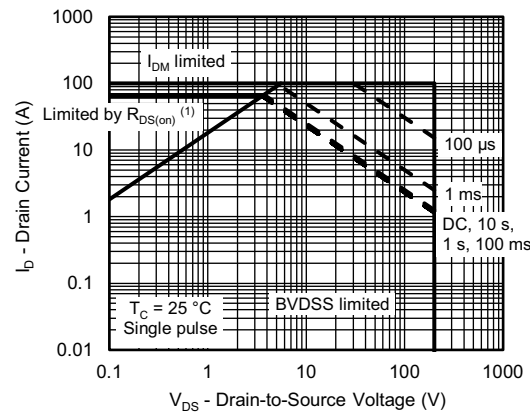

Safe Operating Area, Junction-to-Ambient

TYPICAL CHARACTERISTICS (25 °C, unless otherwise noted)

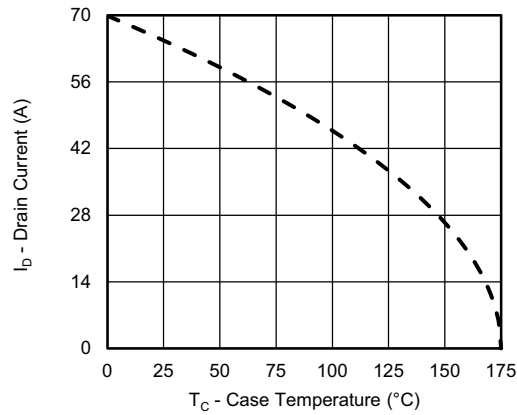

Current Derating ^a

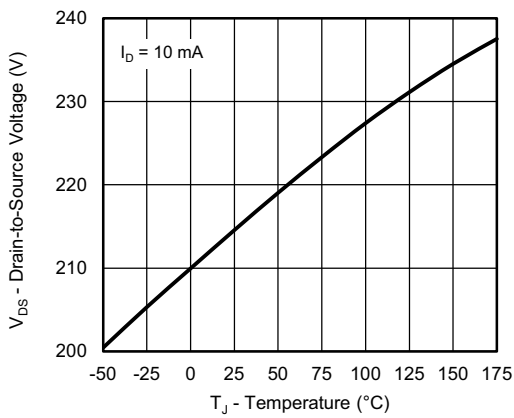

Drain Source Breakdown vs. Junction Temperature

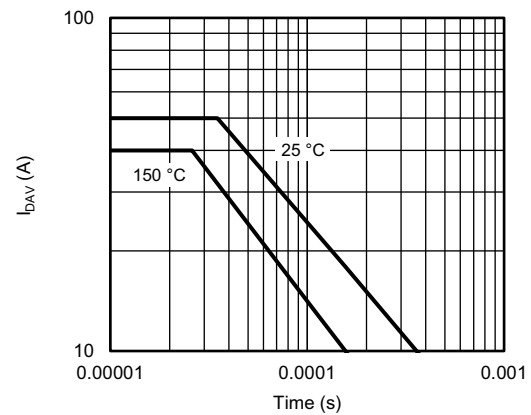

I_{DAV} vs. Time

Note

- a. The power dissipation P_D is based on T_J max. = 25 °C, using junction-to-case thermal resistance, and is more useful in settling the upper dissipation limit for cases where additional heatsinking is used. It is used to determine the current rating, when this rating falls below the package limit.



TYPICAL CHARACTERISTICS (25 °C, unless otherwise noted)

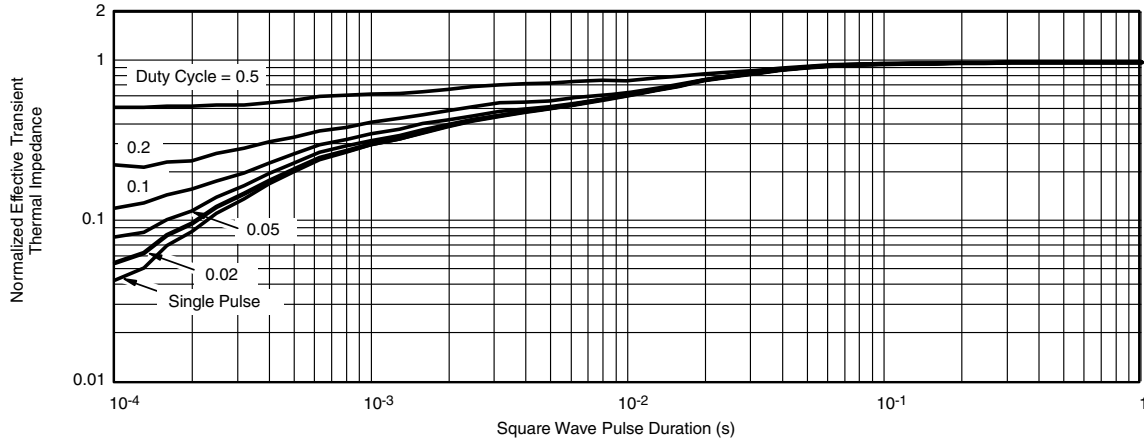

Normalized Thermal Transient Impedance, Junction-to-Ambient

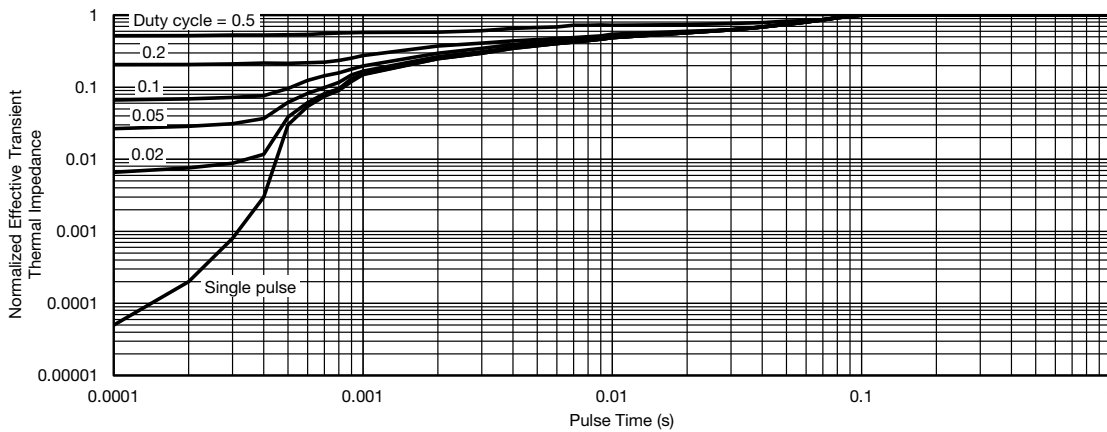

Normalized Thermal Transient Impedance, Junction-to-Case

Vishay Siliconix maintains worldwide manufacturing capability. Products may be manufactured at one of several qualified locations. Reliability data for Silicon Technology and Package Reliability represent a composite of all qualified locations. For related documents such as package/tape drawings, part marking, and reliability data, see www.vishay.com/ppg?75261.



TO-220AB



DIM.	MILLIMETERS		INCHES	
	MIN.	MAX.	MIN.	MAX.
A	4.25	4.65	0.167	0.183
b	0.69	1.01	0.027	0.040
b(1)	1.20	1.73	0.047	0.068
c	0.36	0.61	0.014	0.024
D	14.85	15.49	0.585	0.610
D2	12.19	12.70	0.480	0.500
E	10.04	10.51	0.395	0.414
e	2.41	2.67	0.095	0.105
e(1)	4.88	5.28	0.192	0.208
F	1.14	1.40	0.045	0.055
H(1)	6.09	6.48	0.240	0.255
J(1)	2.41	2.92	0.095	0.115
L	13.35	14.02	0.526	0.552
L(1)	3.32	3.82	0.131	0.150
$\varnothing P$	3.54	3.94	0.139	0.155
Q	2.60	3.00	0.102	0.118

ECN: T14-0413-Rev. P, 16-Jun-14
DWG: 5471

Note

* M = 1.32 mm to 1.62 mm (dimension including protrusion)
Heatsink hole for HVM

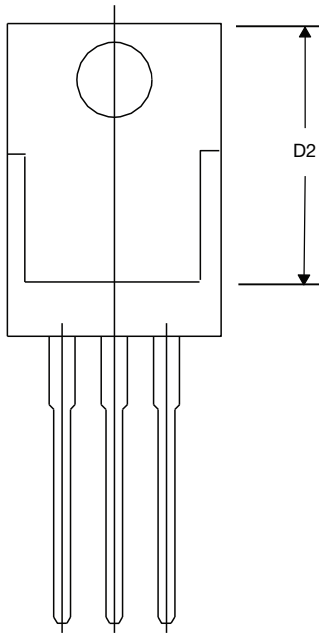



Disclaimer

ALL PRODUCT, PRODUCT SPECIFICATIONS AND DATA ARE SUBJECT TO CHANGE WITHOUT NOTICE TO IMPROVE RELIABILITY, FUNCTION OR DESIGN OR OTHERWISE.

Vishay Intertechnology, Inc., its affiliates, agents, and employees, and all persons acting on its or their behalf (collectively, "Vishay"), disclaim any and all liability for any errors, inaccuracies or incompleteness contained in any datasheet or in any other disclosure relating to any product.

Vishay makes no warranty, representation or guarantee regarding the suitability of the products for any particular purpose or the continuing production of any product. To the maximum extent permitted by applicable law, Vishay disclaims (i) any and all liability arising out of the application or use of any product, (ii) any and all liability, including without limitation special, consequential or incidental damages, and (iii) any and all implied warranties, including warranties of fitness for particular purpose, non-infringement and merchantability.

Statements regarding the suitability of products for certain types of applications are based on Vishay's knowledge of typical requirements that are often placed on Vishay products in generic applications. Such statements are not binding statements about the suitability of products for a particular application. It is the customer's responsibility to validate that a particular product with the properties described in the product specification is suitable for use in a particular application. Parameters provided in datasheets and / or specifications may vary in different applications and performance may vary over time. All operating parameters, including typical parameters, must be validated for each customer application by the customer's technical experts. Product specifications do not expand or otherwise modify Vishay's terms and conditions of purchase, including but not limited to the warranty expressed therein.

Hyperlinks included in this datasheet may direct users to third-party websites. These links are provided as a convenience and for informational purposes only. Inclusion of these hyperlinks does not constitute an endorsement or an approval by Vishay of any of the products, services or opinions of the corporation, organization or individual associated with the third-party website. Vishay disclaims any and all liability and bears no responsibility for the accuracy, legality or content of the third-party website or for that of subsequent links.

Except as expressly indicated in writing, Vishay products are not designed for use in medical, life-saving, or life-sustaining applications or for any other application in which the failure of the Vishay product could result in personal injury or death. Customers using or selling Vishay products not expressly indicated for use in such applications do so at their own risk. Please contact authorized Vishay personnel to obtain written terms and conditions regarding products designed for such applications.

No license, express or implied, by estoppel or otherwise, to any intellectual property rights is granted by this document or by any conduct of Vishay. Product names and markings noted herein may be trademarks of their respective owners.