

MC78L00A Series, NCV78L00A

100 mA Positive Voltage Regulators

The MC78L00A Series of positive voltage regulators are inexpensive, easy-to-use devices suitable for a multitude of applications that require a regulated supply of up to 100 mA. Like their higher powered MC7800 and MC78M00 Series cousins, these regulators feature internal current limiting and thermal shutdown making them remarkably rugged. No external components are required with the MC78L00 devices in many applications.

These devices offer a substantial performance advantage over the traditional zener diode-resistor combination, as output impedance and quiescent current are substantially reduced.

Features

- Wide Range of Available, Fixed Output Voltages
- Low Cost
- Internal Short Circuit Current Limiting
- Internal Thermal Overload Protection
- No External Components Required
- Complementary Negative Regulators Offered (MC79L00A Series)
- Pb-Free Packages are Available
- NCV Prefix for Automotive and Other Applications Requiring Site and Control Changes

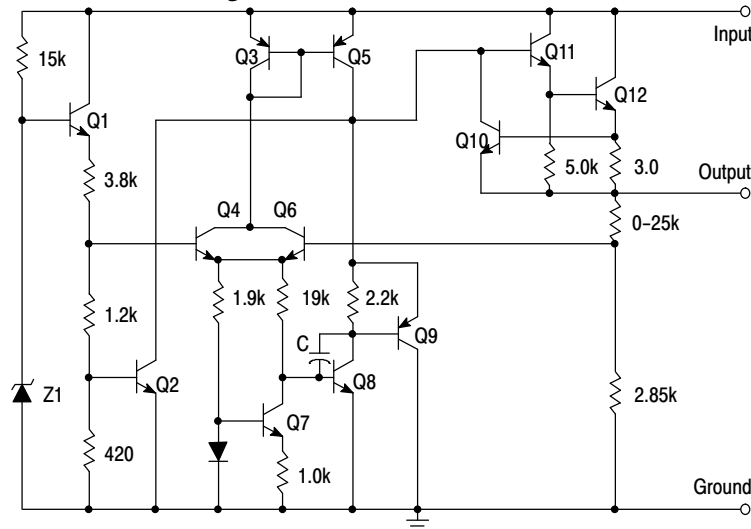

Figure 1. Representative Schematic Diagram

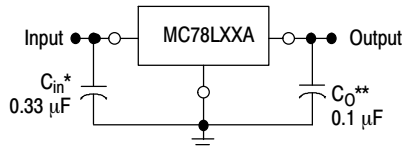

Figure 2. Standard Application

A common ground is required between the input and the output voltages. The input voltage must remain typically 2.0 V above the output voltage even during the low point on the input ripple voltage.

* C_{in} is required if regulator is located an appreciable distance from power supply filter.

** C_o is not needed for stability; however, it does improve transient response.



ON Semiconductor®

<http://onsemi.com>

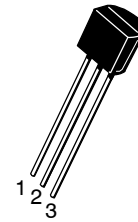

STRAIGHT LEAD
BULK PACK

TO-92
P SUFFIX
CASE 029

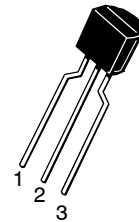

BENT LEAD
TAPE & REEL
AMMO PACK

Pin: 1. Output
2. Ground
3. Input



SOIC-8*
D SUFFIX
CASE 751

*SOIC-8 is an internally modified SO-8 package. Pins 2, 3, 6, and 7 are electrically common to the die attach flag. This internal lead frame modification decreases package thermal resistance and increases power dissipation capability when appropriately mounted on a printed circuit board. SOIC-8 conforms to all external dimensions of the standard SO-8 package.

PIN CONNECTIONS

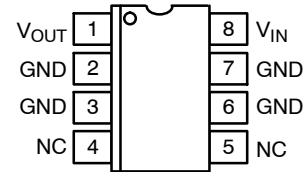

(Top View)

ORDERING INFORMATION

See detailed ordering and shipping information in the package dimensions section on page 10 of this data sheet.

DEVICE MARKING INFORMATION

See general marking information in the device marking section on page 16 of this data sheet.

MC78L00A Series, NCV78L00A

ABSOLUTE MAXIMUM RATINGS

Rating	Symbol	Value	Unit
Input Voltage (5.0 V–9.0 V) (12 V–18 V) (24 V)	V_I	30 35 40	Vdc
Storage Temperature Range	T_{stg}	-65 to +150	°C
Maximum Junction Temperature	T_J	150	°C
Moisture Sensitivity Level	MSL	1	–
ESD Capability, Human Body Model (Note 1)	ESD _{HBM}	2000	V
ESD Capability, Machine Model (Note 1)	ESD _{MM}	200	V
ESD Capability, Charged Device Model (Note 1)	ESD _{CDM}	2000	V

Stresses exceeding Maximum Ratings may damage the device. Maximum Ratings are stress ratings only. Functional operation above the Recommended Operating Conditions is not implied. Extended exposure to stresses above the Recommended Operating Conditions may affect device reliability.

- This device series incorporates ESD protection and is tested by the following methods:
 ESD Human Body Model tested per AEC-Q100-002 (EIA/JESD22-A114)
 ESD Machine Model tested per AEC-Q100-003 (EIA/JESD22-A115)
 ESD Charged Device Model tested per EIA/JES D22/C101, Field Induced Charge Model.

THERMAL CHARACTERISTICS

Rating	Symbol	Value	Unit
Package Dissipation	PD	Internally Limited	W
Thermal Characteristics, TO-92 Thermal Resistance, Junction-to-Ambient	$R_{\theta JA}$	200	°C/W
Thermal Characteristics, SOIC8 Thermal Resistance, Junction-to-Ambient	$R_{\theta JA}$	Refer to Figure 8	°C/W

- Thermal Resistance, Junction-to-Ambient depends on P.C.B. Copper area. See details in Figure 8.

Thermal Resistance, Junction-to-Case is not defined. SOIC 8 lead and TO-92 packages that do not have a heat sink like other packages may have. This is the reason that a Theta JC is never specified. A little heat transfer will occur through the package but since it is plastic, it is minimal. The majority of the heat that is transferred is through the leads where they connect to the circuit board.

MC78L00A Series, NCV78L00A

ELECTRICAL CHARACTERISTICS ($V_I = 10\text{ V}$, $I_O = 40\text{ mA}$, $C_I = 0.33\text{ }\mu\text{F}$, $C_O = 0.1\text{ }\mu\text{F}$, $-40^\circ\text{C} < T_J < +125^\circ\text{C}$ (for MC78LXXAB, NCV78L05A), $0^\circ\text{C} < T_J < +125^\circ\text{C}$ (for MC78LXXAC), unless otherwise noted.)

Characteristics	Symbol	MC78L05AC, AB, NCV78L05A			Unit
		Min	Typ	Max	
Output Voltage ($T_J = +25^\circ\text{C}$)	V_O	4.8	5.0	5.2	Vdc
Line Regulation ($T_J = +25^\circ\text{C}$, $I_O = 40\text{ mA}$) $7.0\text{ Vdc} \leq V_I \leq 20\text{ Vdc}$ $8.0\text{ Vdc} \leq V_I \leq 20\text{ Vdc}$	Reg_{line}	– –	55 45	150 100	mV
Load Regulation ($T_J = +25^\circ\text{C}$, $1.0\text{ mA} \leq I_O \leq 100\text{ mA}$) ($T_J = +25^\circ\text{C}$, $1.0\text{ mA} \leq I_O \leq 40\text{ mA}$)	Reg_{load}	– –	11 5.0	60 30	mV
Output Voltage ($7.0\text{ Vdc} \leq V_I \leq 20\text{ Vdc}$, $1.0\text{ mA} \leq I_O \leq 40\text{ mA}$) ($V_I = 10\text{ V}$, $1.0\text{ mA} \leq I_O \leq 70\text{ mA}$)	V_O	4.75 4.75	– –	5.25 5.25	Vdc
Input Bias Current ($T_J = +25^\circ\text{C}$) ($T_J = +125^\circ\text{C}$)	I_{IB}	– –	3.8 –	6.0 5.5	mA
Input Bias Current Change ($8.0\text{ Vdc} \leq V_I \leq 20\text{ Vdc}$) ($1.0\text{ mA} \leq I_O \leq 40\text{ mA}$)	ΔI_{IB}	– –	– –	1.5 0.1	mA
Output Noise Voltage ($T_A = +25^\circ\text{C}$, $10\text{ Hz} \leq f \leq 100\text{ kHz}$)	V_n	–	40	–	μV
Ripple Rejection ($I_O = 40\text{ mA}$, $f = 120\text{ Hz}$, $8.0\text{ Vdc} \leq V_I \leq 18\text{ V}$, $T_J = +25^\circ\text{C}$)	RR	41	49	–	dB
Dropout Voltage ($T_J = +25^\circ\text{C}$)	$V_I - V_O$	–	1.7	–	Vdc

NOTE: NCV78L05A: $T_{\text{low}} = -40^\circ\text{C}$, $T_{\text{high}} = +125^\circ\text{C}$. Guaranteed by design. NCV prefix is for automotive and other applications requiring site and change control.

MC78L00A Series, NCV78L00A

ELECTRICAL CHARACTERISTICS ($V_I = 14\text{ V}$, $I_O = 40\text{ mA}$, $C_I = 0.33\text{ }\mu\text{F}$, $C_O = 0.1\text{ }\mu\text{F}$, $-40^\circ\text{C} < T_J < +125^\circ\text{C}$ (for MC78LXXAB), $0^\circ\text{C} < T_J < +125^\circ\text{C}$ (for MC78LXXAC), unless otherwise noted.)

Characteristics	Symbol	MC78L08AC, AB			Unit
		Min	Typ	Max	
Output Voltage ($T_J = +25^\circ\text{C}$)	V_O	7.7	8.0	8.3	Vdc
Line Regulation ($T_J = +25^\circ\text{C}$, $I_O = 40\text{ mA}$) $10.5\text{ Vdc} \leq V_I \leq 23\text{ Vdc}$ $11\text{ Vdc} \leq V_I \leq 23\text{ Vdc}$	Reg_{line}	– –	20 12	175 125	mV
Load Regulation ($T_J = +25^\circ\text{C}$, $1.0\text{ mA} \leq I_O \leq 100\text{ mA}$) ($T_J = +25^\circ\text{C}$, $1.0\text{ mA} \leq I_O \leq 40\text{ mA}$)	Reg_{load}	– –	15 8.0	80 40	mV
Output Voltage ($10.5\text{ Vdc} \leq V_I \leq 23\text{ Vdc}$, $1.0\text{ mA} \leq I_O \leq 40\text{ mA}$) ($V_I = 14\text{ V}$, $1.0\text{ mA} \leq I_O \leq 70\text{ mA}$)	V_O	7.6 7.6	– –	8.4 8.4	Vdc
Input Bias Current ($T_J = +25^\circ\text{C}$) ($T_J = +125^\circ\text{C}$)	I_{IB}	– –	3.0 –	6.0 5.5	mA
Input Bias Current Change ($11\text{ Vdc} \leq V_I \leq 23\text{ Vdc}$) ($1.0\text{ mA} \leq I_O \leq 40\text{ mA}$)	ΔI_{IB}	– –	– –	1.5 0.1	mA
Output Noise Voltage ($T_A = +25^\circ\text{C}$, $10\text{ Hz} \leq f \leq 100\text{ kHz}$)	V_n	–	60	–	μV
Ripple Rejection ($I_O = 40\text{ mA}$, $f = 120\text{ Hz}$, $12\text{ V} \leq V_I \leq 23\text{ V}$, $T_J = +25^\circ\text{C}$)	RR	37	57	–	dB
Dropout Voltage ($T_J = +25^\circ\text{C}$)	$V_I - V_O$	–	1.7	–	Vdc

ELECTRICAL CHARACTERISTICS ($V_I = 15\text{ V}$, $I_O = 40\text{ mA}$, $C_I = 0.33\text{ }\mu\text{F}$, $C_O = 0.1\text{ }\mu\text{F}$, $-40^\circ\text{C} < T_J < +125^\circ\text{C}$ (for MC78LXXAB), $0^\circ\text{C} < T_J < +125^\circ\text{C}$ (for MC78LXXAC), unless otherwise noted.)

Characteristics	Symbol	MC78L09AC, AB			Unit
		Min	Typ	Max	
Output Voltage ($T_J = +25^\circ\text{C}$)	V_O	8.6	9.0	9.4	Vdc
Line Regulation ($T_J = +25^\circ\text{C}$, $I_O = 40\text{ mA}$) $11.5\text{ Vdc} \leq V_I \leq 24\text{ Vdc}$ $12\text{ Vdc} \leq V_I \leq 24\text{ Vdc}$	Reg_{line}	– –	20 12	175 125	mV
Load Regulation ($T_J = +25^\circ\text{C}$, $1.0\text{ mA} \leq I_O \leq 100\text{ mA}$) ($T_J = +25^\circ\text{C}$, $1.0\text{ mA} \leq I_O \leq 40\text{ mA}$)	Reg_{load}	– –	15 8.0	90 40	mV
Output Voltage ($11.5\text{ Vdc} \leq V_I \leq 24\text{ Vdc}$, $1.0\text{ mA} \leq I_O \leq 40\text{ mA}$) ($V_I = 15\text{ V}$, $1.0\text{ mA} \leq I_O \leq 70\text{ mA}$)	V_O	8.5 8.5	– –	9.5 9.5	Vdc
Input Bias Current ($T_J = +25^\circ\text{C}$) ($T_J = +125^\circ\text{C}$)	I_{IB}	– –	3.0 –	6.0 5.5	mA
Input Bias Current Change ($11\text{ Vdc} \leq V_I \leq 23\text{ Vdc}$) ($1.0\text{ mA} \leq I_O \leq 40\text{ mA}$)	ΔI_{IB}	– –	– –	1.5 0.1	mA
Output Noise Voltage ($T_A = +25^\circ\text{C}$, $10\text{ Hz} \leq f \leq 100\text{ kHz}$)	V_n	–	60	–	μV
Ripple Rejection ($I_O = 40\text{ mA}$, $f = 120\text{ Hz}$, $13\text{ V} \leq V_I \leq 24\text{ V}$, $T_J = +25^\circ\text{C}$)	RR	37	57	–	dB
Dropout Voltage ($T_J = +25^\circ\text{C}$)	$V_I - V_O$	–	1.7	–	Vdc

MC78L00A Series, NCV78L00A

ELECTRICAL CHARACTERISTICS ($V_I = 19\text{ V}$, $I_O = 40\text{ mA}$, $C_I = 0.33\text{ }\mu\text{F}$, $C_O = 0.1\text{ }\mu\text{F}$, $-40^\circ\text{C} < T_J < +125^\circ\text{C}$ (for MC78LXXAB), $0^\circ\text{C} < T_J < +125^\circ\text{C}$ (for MC78LXXAC), unless otherwise noted.)

Characteristics	Symbol	MC78L12AC, AB			Unit
		Min	Typ	Max	
Output Voltage ($T_J = +25^\circ\text{C}$)	V_O	11.5	12	12.5	Vdc
Line Regulation ($T_J = +25^\circ\text{C}$, $I_O = 40\text{ mA}$) $14.5\text{ Vdc} \leq V_I \leq 27\text{ Vdc}$ $16\text{ Vdc} \leq V_I \leq 27\text{ Vdc}$	Reg_{line}	– –	120 100	250 200	mV
Load Regulation ($T_J = +25^\circ\text{C}$, $1.0\text{ mA} \leq I_O \leq 100\text{ mA}$) ($T_J = +25^\circ\text{C}$, $1.0\text{ mA} \leq I_O \leq 40\text{ mA}$)	Reg_{load}	– –	20 10	100 50	mV
Output Voltage ($14.5\text{ Vdc} \leq V_I \leq 27\text{ Vdc}$, $1.0\text{ mA} \leq I_O \leq 40\text{ mA}$) ($V_I = 19\text{ V}$, $1.0\text{ mA} \leq I_O \leq 70\text{ mA}$)	V_O	11.4 11.4	– –	12.6 12.6	Vdc
Input Bias Current ($T_J = +25^\circ\text{C}$) ($T_J = +125^\circ\text{C}$)	I_{IB}	– –	4.2 –	6.5 6.0	mA
Input Bias Current Change ($16\text{ Vdc} \leq V_I \leq 27\text{ Vdc}$) ($1.0\text{ mA} \leq I_O \leq 40\text{ mA}$)	ΔI_{IB}	– –	– –	1.5 0.1	mA
Output Noise Voltage ($T_A = +25^\circ\text{C}$, $10\text{ Hz} \leq f \leq 100\text{ kHz}$)	V_n	–	80	–	μV
Ripple Rejection ($I_O = 40\text{ mA}$, $f = 120\text{ Hz}$, $15\text{ V} \leq V_I \leq 25\text{ V}$, $T_J = +25^\circ\text{C}$)	RR	37	42	–	dB
Dropout Voltage ($T_J = +25^\circ\text{C}$)	$V_I - V_O$	–	1.7	–	Vdc

ELECTRICAL CHARACTERISTICS ($V_I = 23\text{ V}$, $I_O = 40\text{ mA}$, $C_I = 0.33\text{ }\mu\text{F}$, $C_O = 0.1\text{ }\mu\text{F}$, $-40^\circ\text{C} < T_J < +125^\circ\text{C}$ (for MC78LXXAB), $0^\circ\text{C} < T_J < +125^\circ\text{C}$ (for MC78LXXAC), unless otherwise noted.)

Characteristics	Symbol	MC78L15AC, AB / NCV78L15A			Unit
		Min	Typ	Max	
Output Voltage ($T_J = +25^\circ\text{C}$)	V_O	14.4	15	15.6	Vdc
Line Regulation ($T_J = +25^\circ\text{C}$, $I_O = 40\text{ mA}$) $17.5\text{ Vdc} \leq V_I \leq 30\text{ Vdc}$ $20\text{ Vdc} \leq V_I \leq 30\text{ Vdc}$	Reg_{line}	– –	130 110	300 250	mV
Load Regulation ($T_J = +25^\circ\text{C}$, $1.0\text{ mA} \leq I_O \leq 100\text{ mA}$) ($T_J = +25^\circ\text{C}$, $1.0\text{ mA} \leq I_O \leq 40\text{ mA}$)	Reg_{load}	– –	25 12	150 75	mV
Output Voltage ($17.5\text{ Vdc} \leq V_I \leq 30\text{ Vdc}$, $1.0\text{ mA} \leq I_O \leq 40\text{ mA}$) ($V_I = 23\text{ V}$, $1.0\text{ mA} \leq I_O \leq 70\text{ mA}$)	V_O	14.25 14.25	– –	15.75 15.75	Vdc
Input Bias Current ($T_J = +25^\circ\text{C}$) ($T_J = +125^\circ\text{C}$)	I_{IB}	– –	4.4 –	6.5 6.0	mA
Input Bias Current Change ($20\text{ Vdc} \leq V_I \leq 30\text{ Vdc}$) ($1.0\text{ mA} \leq I_O \leq 40\text{ mA}$)	ΔI_{IB}	– –	– –	1.5 0.1	mA
Output Noise Voltage ($T_A = +25^\circ\text{C}$, $10\text{ Hz} \leq f \leq 100\text{ kHz}$)	V_n	–	90	–	μV
Ripple Rejection ($I_O = 40\text{ mA}$, $f = 120\text{ Hz}$, $18.5\text{ V} \leq V_I \leq 28.5\text{ V}$, $T_J = +25^\circ\text{C}$)	RR	34	39	–	dB
Dropout Voltage ($T_J = +25^\circ\text{C}$)	$V_I - V_O$	–	1.7	–	Vdc

MC78L00A Series, NCV78L00A

ELECTRICAL CHARACTERISTICS ($V_I = 27\text{ V}$, $I_O = 40\text{ mA}$, $C_I = 0.33\text{ }\mu\text{F}$, $C_O = 0.1\text{ }\mu\text{F}$, $0^\circ\text{C} < T_J < +125^\circ\text{C}$, unless otherwise noted.)

Characteristics	Symbol	MC78L18AC			Unit
		Min	Typ	Max	
Output Voltage ($T_J = +25^\circ\text{C}$)	V_O	17.3	18	18.7	Vdc
Line Regulation ($T_J = +25^\circ\text{C}$, $I_O = 40\text{ mA}$) 21.4 Vdc $\leq V_I \leq 33\text{ Vdc}$ 20.7 Vdc $\leq V_I \leq 33\text{ Vdc}$ 22 Vdc $\leq V_I \leq 33\text{ Vdc}$ 21 Vdc $\leq V_I \leq 33\text{ Vdc}$	Reg_{line}	–	45	325	mV
Load Regulation ($T_J = +25^\circ\text{C}$, $1.0\text{ mA} \leq I_O \leq 100\text{ mA}$) ($T_J = +25^\circ\text{C}$, $1.0\text{ mA} \leq I_O \leq 40\text{ mA}$)	Reg_{load}	–	30	170	mV
Output Voltage (21.4 Vdc $\leq V_I \leq 33\text{ Vdc}$, $1.0\text{ mA} \leq I_O \leq 40\text{ mA}$) (20.7 Vdc $\leq V_I \leq 33\text{ Vdc}$, $1.0\text{ mA} \leq I_O \leq 40\text{ mA}$) ($V_I = 27\text{ V}$, $1.0\text{ mA} \leq I_O \leq 70\text{ mA}$) ($V_I = 27\text{ V}$, $1.0\text{ mA} \leq I_O \leq 70\text{ mA}$)	V_O	17.1	–	18.9	Vdc
Input Bias Current ($T_J = +25^\circ\text{C}$) ($T_J = +125^\circ\text{C}$)	I_{IB}	–	3.1	6.5	mA
Input Bias Current Change (22 Vdc $\leq V_I \leq 33\text{ Vdc}$) (21 Vdc $\leq V_I \leq 33\text{ Vdc}$) (1.0 mA $\leq I_O \leq 40\text{ mA}$)	ΔI_{IB}	–	–	1.5	mA
Output Noise Voltage ($T_A = +25^\circ\text{C}$, $10\text{ Hz} \leq f \leq 100\text{ kHz}$)	V_n	–	150	–	μV
Ripple Rejection ($I_O = 40\text{ mA}$, $f = 120\text{ Hz}$, $23\text{ V} \leq V_I \leq 33\text{ V}$, $T_J = +25^\circ\text{C}$)	RR	33	48	–	dB
Dropout Voltage ($T_J = +25^\circ\text{C}$)	$V_I - V_O$	–	1.7	–	Vdc

MC78L00A Series, NCV78L00A

ELECTRICAL CHARACTERISTICS ($V_I = 33\text{ V}$, $I_O = 40\text{ mA}$, $C_I = 0.33\text{ }\mu\text{F}$, $C_O = 0.1\text{ }\mu\text{F}$, $0^\circ\text{C} < T_J < +125^\circ\text{C}$, unless otherwise noted.)

Characteristics	Symbol	MC78L24AC			Unit
		Min	Typ	Max	
Output Voltage ($T_J = +25^\circ\text{C}$)	V_O	23	24	25	Vdc
Line Regulation ($T_J = +25^\circ\text{C}$, $I_O = 40\text{ mA}$) $27.5\text{ Vdc} \leq V_I \leq 38\text{ Vdc}$ $28\text{ Vdc} \leq V_I \leq 80\text{ Vdc}$ $27\text{ Vdc} \leq V_I \leq 38\text{ Vdc}$	Reg_{line}	–	–	–	mV
Load Regulation ($T_J = +25^\circ\text{C}$, $1.0\text{ mA} \leq I_O \leq 100\text{ mA}$) ($T_J = +25^\circ\text{C}$, $1.0\text{ mA} \leq I_O \leq 40\text{ mA}$)	Reg_{load}	–	40	200	mV
Output Voltage ($28\text{ Vdc} \leq V_I \leq 38\text{ Vdc}$, $1.0\text{ mA} \leq I_O \leq 40\text{ mA}$) ($27\text{ Vdc} \leq V_I \leq 38\text{ Vdc}$, $1.0\text{ mA} \leq I_O \leq 40\text{ mA}$) ($28\text{ Vdc} \leq V_I = 33\text{ Vdc}$, $1.0\text{ mA} \leq I_O \leq 70\text{ mA}$) ($27\text{ Vdc} \leq V_I \leq 33\text{ Vdc}$, $1.0\text{ mA} \leq I_O \leq 70\text{ mA}$)	V_O	22.8	–	25.2	Vdc
Input Bias Current ($T_J = +25^\circ\text{C}$) ($T_J = +125^\circ\text{C}$)	I_{IB}	–	3.1	6.5	mA
Input Bias Current Change ($28\text{ Vdc} \leq V_I \leq 38\text{ Vdc}$) ($1.0\text{ mA} \leq I_O \leq 40\text{ mA}$)	ΔI_{IB}	–	–	1.5	mA
Output Noise Voltage ($T_A = +25^\circ\text{C}$, $10\text{ Hz} \leq f \leq 100\text{ kHz}$)	V_n	–	200	–	μV
Ripple Rejection ($I_O = 40\text{ mA}$, $f = 120\text{ Hz}$, $29\text{ V} \leq V_I \leq 35\text{ V}$, $T_J = +25^\circ\text{C}$)	RR	31	45	–	dB
Dropout Voltage ($T_J = +25^\circ\text{C}$)	$V_I - V_O$	–	1.7	–	Vdc

MC78L00A Series, NCV78L00A

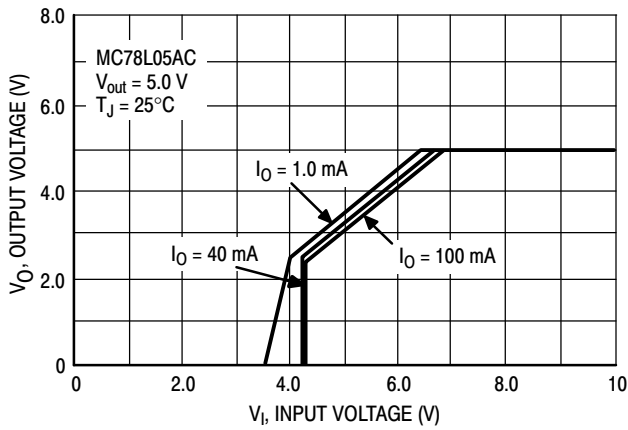

Figure 3. Dropout Characteristics

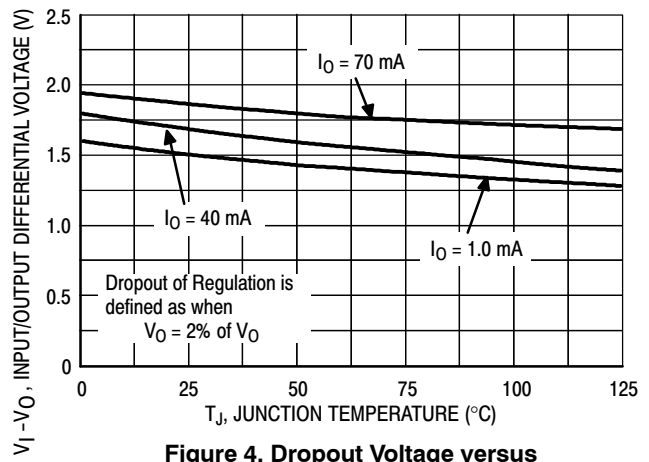

Figure 4. Dropout Voltage versus Junction Temperature

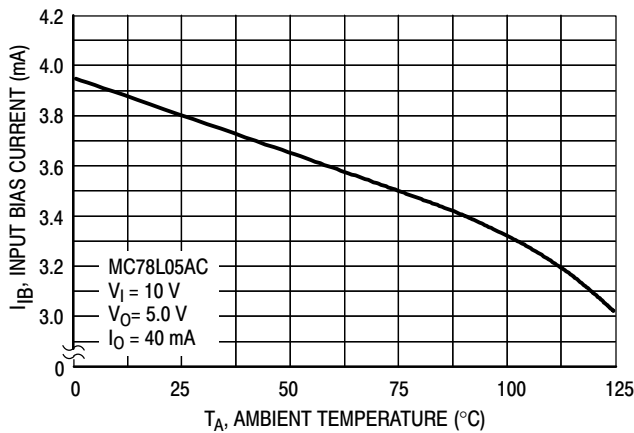

Figure 5. Input Bias Current versus Ambient Temperature

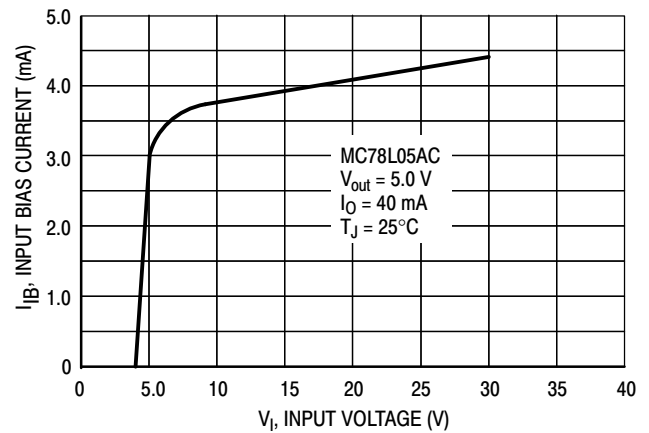

Figure 6. Input Bias Current versus Input Voltage

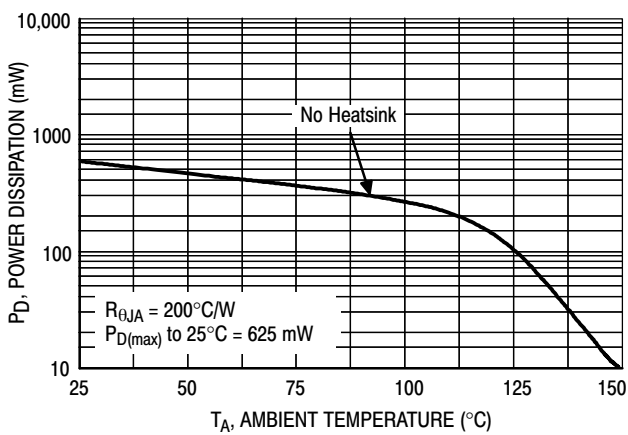

Figure 7. Maximum Average Power Dissipation versus Ambient Temperature - TO-92 Type Package

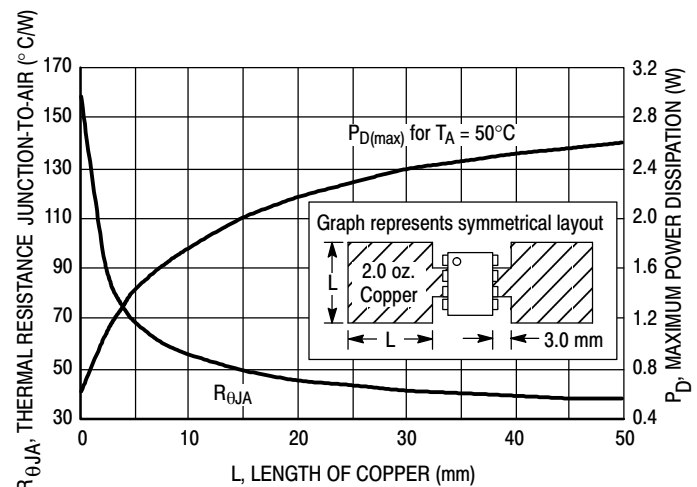

Figure 8. SOIC-8 Thermal Resistance and Maximum Power Dissipation versus P.C.B. Copper Length

MC78L00A Series, NCV78L00A

APPLICATIONS INFORMATION

Design Considerations

The MC78L00A Series of fixed voltage regulators are designed with Thermal Overload Protection that shuts down the circuit when subjected to an excessive power overload condition. Internal Short Circuit Protection limits the maximum current the circuit will pass.

In many low current applications, compensation capacitors are not required. However, it is recommended that the regulator input be bypassed with a capacitor if the regulator is connected to the power supply filter with long wire lengths, or if the output load capacitance is large. The

input bypass capacitor should be selected to provide good high-frequency characteristics to insure stable operation under all load conditions. A 0.33 μF or larger tantalum, mylar, or other capacitor having low internal impedance at high frequencies should be chosen. The bypass capacitor should be mounted with the shortest possible leads directly across the regulators input terminals. Good construction techniques should be used to minimize ground loops and lead resistance drops since the regulator has no external sense lead. Bypassing the output is also recommended.

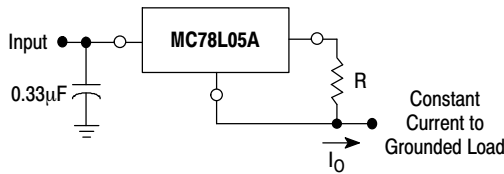

The MC78L00 regulators can also be used as a current source when connected as above. In order to minimize dissipation the MC78L05C is chosen in this application. Resistor R determines the current as follows:

$$I_O = \frac{5.0 \text{ V}}{R} + I_B$$

$$I_B = 3.8 \text{ mA over line and load changes}$$

For example, a 100 mA current source would require R to be a 50 Ω, 1/2 W resistor and the output voltage compliance would be the input voltage less 7 V.

Figure 9. Current Regulator

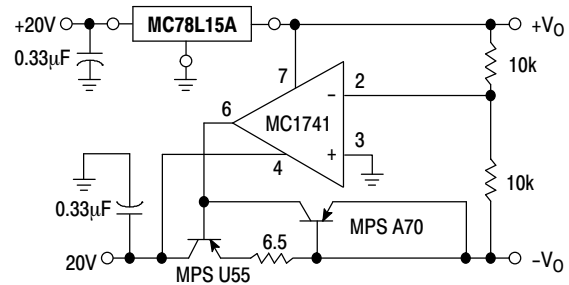

Figure 10. ± 15 V Tracking Voltage Regulator

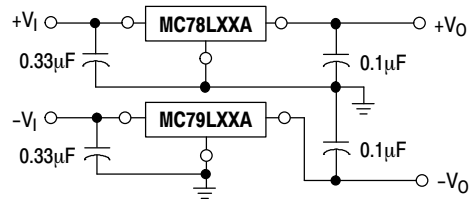

Figure 11. Positive and Negative Regulator

MC78L00A Series, NCV78L00A

ORDERING INFORMATION

Device	Output Voltage	Operating Temperature Range	Package	Shipping [†]
MC78L05ABD	5.0 V	$T_J = -40^\circ \text{ to } +125^\circ \text{C}$	SOIC-8	98 Units/Rail
MC78L05ABDG			SOIC-8 (Pb-Free)	98 Units/Rail
NCV78L05ABDG*			SOIC-8 (Pb-Free)	98 Units/Rail
MC78L05ABDR2			SOIC-8	2500 Tape & Reel
MC78L05ABDR2G			SOIC-8 (Pb-Free)	2500 Tape & Reel
NCV78L05ABDR2*			SOIC-8	2500 Tape & Reel
NCV78L05ABDR2G*			SOIC-8 (Pb-Free)	2500 Tape & Reel
MC78L05ABP			TO-92	2000 Units/Bag
MC78L05ABPG			TO-92 (Pb-Free)	2000 Units/Bag
NCV78L05ABPG*			TO-92 (Pb-Free)	2000 Units/Bag
MC78L05ABPRA			TO-92	2000 Tape & Reel
MC78L05ABPRAG			TO-92 (Pb-Free)	2000 Tape & Reel
NCV78L05ABPRAG*			TO-92 (Pb-Free)	2000 Tape & Reel
MC78L05ABPRE			TO-92	2000 Tape & Reel
MC78L05ABPREG			TO-92 (Pb-Free)	2000 Tape & Reel
NCV78L05ABPREG*			TO-92 (Pb-Free)	2000 Tape & Reel
MC78L05ABPRM			TO-92	2000 Ammo Pack
MC78L05ABPRMG			TO-92 (Pb-Free)	2000 Ammo Pack
NCV78L05ABPRMG*			TO-92 (Pb-Free)	2000 Ammo Pack
NCV78L05ABPRPG*			TO-92 (Pb-Free)	2000 Ammo Pack
MC78L05ACD	5.0 V	$T_J = 0^\circ \text{ to } +125^\circ \text{C}$	SOIC-8	98 Units/Rail
MC78L05ACDG			SOIC-8 (Pb-Free)	98 Units/Rail
MC78L05ACDR2			SOIC-8	2500 Tape & Reel
MC78L05ACDR2G			SOIC-8 (Pb-Free)	2500 Tape & Reel
MC78L05ACP			TO-92	2000 Units/Bag
MC78L05ACPG			TO-92 (Pb-Free)	2000 Units/Bag
MC78L05ACPRA			TO-92	2000 Tape & Reel
MC78L05ACPRAG			TO-92 (Pb-Free)	2000 Tape & Reel
MC78L05ACPRE			TO-92	2000 Tape & Reel
MC78L05ACPREG			TO-92 (Pb-Free)	2000 Tape & Reel
MC78L05ACPRM			TO-92	2000 Ammo Pack
MC78L05ACPRMG			TO-92 (Pb-Free)	2000 Ammo Pack
MC78L05ACPRP			TO-92	2000 Ammo Pack
MC78L05ACPRPG			TO-92 (Pb-Free)	2000 Ammo Pack

*NCV78L05A: $T_{low} = -40^\circ \text{C}$, $T_{high} = +125^\circ \text{C}$. Guaranteed by design. NCV prefix is for automotive and other applications requiring site and change control.

†For information on tape and reel specifications, including part orientation and tape sizes, please refer to our Tape and Reel Packaging Specifications Brochure, BRD8011/D.

MC78L00A Series, NCV78L00A

ORDERING INFORMATION (continued)

Device	Output Voltage	Operating Temperature Range	Package	Shipping [†]	
MC78L08ABD	8.0 V	$T_J = -40^\circ \text{ to } +125^\circ \text{C}$	SOIC-8	98 Units/Rail	
MC78L08ABDG			SOIC-8 (Pb-Free)	98 Units/Rail	
MC78L08ABDR2			SOIC-8	2500 Tape & Reel	
MC78L08ABDR2G			SOIC-8 (Pb-Free)	2500 Tape & Reel	
NCV78L08ABDR2*			SOIC-8	2500 Tape & Reel	
NCV78L08ABDR2G*			SOIC-8 (Pb-Free)	2500 Tape & Reel	
MC78L08ABP			TO-92	2000 Units/Bag	
MC78L08ABPG			TO-92 (Pb-Free)	2000 Units/Bag	
MC78L08ABPRA			TO-92	2000 Tape & Reel	
MC78L08ABPRAG			TO-92 (Pb-Free)	2000 Tape & Reel	
MC78L08ABPRP			TO-92	2000 Ammo Pack	
MC78L08ABPRPG			TO-92 (Pb-Free)	2000 Ammo Pack	
MC78L08ACD			$T_J = 0^\circ \text{ to } +125^\circ \text{C}$	SOIC-8	98 Units/Rail
MC78L08ACDG				SOIC-8 (Pb-Free)	98 Units/Rail
MC78L08ACDR2		SOIC-8		2500 Tape & Reel	
MC78L08ACDR2G		SOIC-8 (Pb-Free)		2500 Tape & Reel	
MC78L08ACP		TO-92		2000 Units/Bag	
MC78L08ACPG		TO-92 (Pb-Free)		2000 Units/Bag	
MC78L08ACPRA		TO-92		2000 Tape & Reel	
MC78L08ACPRA		TO-92 (Pb-Free)		2000 Tape & Reel	
MC78L08ACPRE		TO-92		2000 Tape & Reel	
MC78L08ACPREG		TO-92 (Pb-Free)		2000 Tape & Reel	
MC78L08ACPRP		TO-92		2000 Ammo Pack	
MC78L08ACPRPG		TO-92 (Pb-Free)		2000 Ammo Pack	

MC78L00A Series, NCV78L00A

ORDERING INFORMATION (continued)(continued)

Device	Output Voltage	Operating Temperature Range	Package	Shipping†
MC78L09ABD	9.0 V	$T_J = -40^\circ \text{ to } +125^\circ \text{C}$	SOIC-8	98 Units/Rail
MC78L09ABDG			SOIC-8 (Pb-Free)	98 Units/Rail
MC78L09ABDR2			SOIC-8	2500 Tape & Reel
MC78L09ABDR2G			SOIC-8 (Pb-Free)	2500 Tape & Reel
MC78L09ABPRA			TO-92	2000 Tape & Reel
MC78L09ABPRAG			TO-92 (Pb-Free)	2000 Tape & Reel
MC78L09ABPRP			TO-92	2000 Ammo Pack
MC78L09ABPRPG			TO-92 (Pb-Free)	2000 Ammo Pack
MC78L09ACD	9.0 V	$T_J = 0^\circ \text{ to } +125^\circ \text{C}$	SOIC-8	98 Units/Rail
MC78L09ACDG			SOIC-8 (Pb-Free)	98 Units/Rail
MC78L09ACDR2			SOIC-8	2500 Tape & Reel
MC78L09ACDR2G			SOIC-8 (Pb-Free)	2500 Tape & Reel
MC78L09ACP			TO-92	2000 Units/Bag
MC78L09ACPG			TO-92 (Pb-Free)	2000 Units/Bag

†For information on tape and reel specifications, including part orientation and tape sizes, please refer to our Tape and Reel Packaging Specifications Brochure, BRD8011/D.

MC78L00A Series, NCV78L00A

ORDERING INFORMATION (continued)

Device	Output Voltage	Operating Temperature Range	Package	Shipping [†]
MC78L12ABD	12 V	$T_J = -40^\circ \text{ to } +125^\circ \text{C}$	SOIC-8	98 Units/Rail
MC78L12ABDG			SOIC-8 (Pb-Free)	98 Units/Rail
MC78L12ABDR2			SOIC-8	2500 Tape & Reel
MC78L12ABDR2G			SOIC-8 (Pb-Free)	2500 Tape & Reel
NCV78L12ABDG*			SOIC-8 (Pb-Free)	98 Units/Rail
NCV78L12ABDR2*			SOIC-8	2500 Tape & Reel
NCV78L12ABDR2G*			SOIC-8 (Pb-Free)	2500 Tape & Reel
MC78L12ABP			TO-92	2000 Units/Bag
MC78L12ABPG			TO-92 (Pb-Free)	2000 Units/Bag
MC78L12ABPRP			TO-92	2000 Ammo Pack
MC78L12ABPRPG			TO-92 (Pb-Free)	2000 Ammo Pack
NCV78L12ABPG*			TO-92 (Pb-Free)	2000 Units/Bag
MC78L12ACD			$T_J = 0^\circ \text{ to } +125^\circ \text{C}$	SOIC-8
MC78L12ACDG		SOIC-8 (Pb-Free)		98 Units/Rail
MC78L12ACDR2		SOIC-8		2500 Tape & Reel
MC78L12ACDR2G		SOIC-8 (Pb-Free)		2500 Tape & Reel
MC78L12ACP		TO-92		2000 Units/Bag
MC78L12ACPG		TO-92 (Pb-Free)		2000 Units/Bag
MC78L12ACPRA		TO-92		2000 Tape & Reel
MC78L12ACPRA		TO-92 (Pb-Free)		2000 Tape & Reel
MC78L12ACPRE		TO-92		2000 Tape & Reel
MC78L12ACPREG	TO-92 (Pb-Free)	2000 Tape & Reel		
MC78L12ACPRM	TO-92	2000 Ammo Pack		
MC78L12ACPRMG	TO-92 (Pb-Free)	2000 Ammo Pack		
MC78L12ACPRP	TO-92	2000 Ammo Pack		
MC78L12ACPRPG	TO-92 (Pb-Free)	2000 Ammo Pack		

*NCV78L12A: $T_{low} = -40^\circ \text{C}$, $T_{high} = +125^\circ \text{C}$. Guaranteed by design. NCV prefix is for automotive and other applications requiring site and change control.
[†]For information on tape and reel specifications, including part orientation and tape sizes, please refer to our Tape and Reel Packaging Specifications Brochure, BRD8011/D.

MC78L00A Series, NCV78L00A

ORDERING INFORMATION (continued)

Device	Output Voltage	Operating Temperature Range	Package	Shipping [†]	
MC78L15ABD	15 V	$T_J = -40^\circ \text{ to } +125^\circ \text{C}$	SOIC-8	98 Units/Rail	
MC78L15ABDG			SOIC-8 (Pb-Free)	98 Units/Rail	
MC78L15ABDR2			SOIC-8	2500 Tape & Reel	
MC78L15ABDR2G			SOIC-8 (Pb-Free)	2500 Tape & Reel	
NCV78L15ABDR2G*			SOIC-8 (Pb-Free)	2500 Tape & Reel	
MC78L15ABP			TO-92	2000 Units/Bag	
MC78L15ABPG			TO-92 (Pb-Free)	2000 Units/Bag	
MC78L15ABPRA			TO-92	2000 Tape & Reel	
MC78L15ABPRAG			TO-92 (Pb-Free)	2000 Tape & Reel	
MC78L15ABPRP			TO-92	2000 Ammo Pack	
MC78L15ABPRPG			TO-92 (Pb-Free)	2000 Ammo Pack	
MC78L15ACD			SOIC-8	98 Units/Rail	
MC78L15ACDG		SOIC-8 (Pb-Free)	98 Units/Rail		
MC78L15ACDR2		SOIC-8	2500 Tape & Reel		
MC78L15ACDR2G		SOIC-8 (Pb-Free)	2500 Tape & Reel		
MC78L15ACP		TO-92	2000 Units/Bag		
MC78L15ACPG		TO-92 (Pb-Free)	2000 Units/Bag		
MC78L15ACPRA		TO-92	2000 Tape & Reel		
MC78L15ACPRAG		TO-92 (Pb-Free)	2000 Tape & Reel		
MC78L15ACPRP		TO-92	2000 Ammo Pack		
MC78L15ACPRPG		TO-92 (Pb-Free)	2000 Ammo Pack		
			$T_J = 0^\circ \text{ to } +125^\circ \text{C}$		

*NCV78L15A: $T_{low} = -40^\circ \text{C}$, $T_{high} = +125^\circ \text{C}$. Guaranteed by design. NCV prefix is for automotive and other applications requiring site and change control.

†For information on tape and reel specifications, including part orientation and tape sizes, please refer to our Tape and Reel Packaging Specifications Brochure, BRD8011/D.

MC78L00A Series, NCV78L00A

ORDERING INFORMATION (continued)

Device	Output Voltage	Operating Temperature Range	Package	Shipping†
MC78L18ABP	18 V	$T_J = -40^\circ \text{ to } +125^\circ \text{C}$	TO-92	2000 Units/Bag
MC78L18ABPG			TO-92 (Pb-Free)	2000 Units/Bag
MC78L18ACP		$T_J = 0^\circ \text{ to } +125^\circ \text{C}$	TO-92	2000 Units/Bag
MC78L18ACPG			TO-92 (Pb-Free)	2000 Units/Bag
MC78L18ACPRA			TO-92	2000 Tape & Reel
MC78L18ACPRA			TO-92 (Pb-Free)	2000 Tape & Reel
MC78L18ACPRM			TO-92	2000 Ammo Pack
MC78L18ACPRMG			TO-92 (Pb-Free)	2000 Ammo Pack
MC78L18ACPRP			TO-92	2000 Ammo Pack
MC78L18ACPRPG			TO-92 (Pb-Free)	2000 Ammo Pack
MC78L24ABP			24 V	$T_J = -40^\circ \text{ to } +125^\circ \text{C}$
MC78L24ABPG	TO-92 (Pb-Free)	2000 Units/Bag		
NCV78L24ABPRPG*	TO-92 (Pb-Free)	2000 Units/Bag		
MC78L24ACP	$T_J = 0^\circ \text{ to } +125^\circ \text{C}$	TO-92		2000 Units/Bag
MC78L24ACPG		TO-92 (Pb-Free)		2000 Units/Bag
MC78L24ACPRA		TO-92		2000 Tape & Reel
MC78L24ACPRA		TO-92 (Pb-Free)		2000 Tape & Reel
MC78L24ACPRP		TO-92		2000 Ammo Pack
MC78L24ACPRPG		TO-92 (Pb-Free)		2000 Ammo Pack

†For information on tape and reel specifications, including part orientation and tape sizes, please refer to our Tape and Reel Packaging Specifications Brochure, BRD8011/D.

MC78L00A Series, NCV78L00A

MARKING DIAGRAMS

SOIC-8 D SUFFIX CASE 751

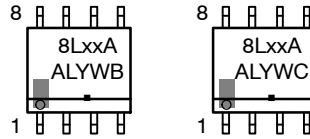

- xx = 05, 08, 09, 12, or 15
- A = Assembly Location
- L = Wafer Lot
- Y = Year
- W = Work Week
- B, C = Temperature Range
- = Pb-Free Package

TO-92 P SUFFIX CASE 029

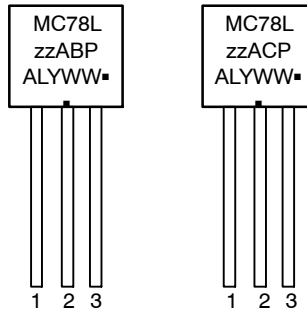

- zz = 05, 08, 09, 12, 15, 18 or 24
 - A = Assembly Location
 - L = Wafer Lot
 - Y = Year
 - WW = Work Week
 - = Pb-Free Package
- (Note: Microdot may be in either location)

MC78L00A Series, NCV78L00A

PACKAGE DIMENSIONS

SOIC-8 NB
D SUFFIX
CASE 751-07
ISSUE AJ

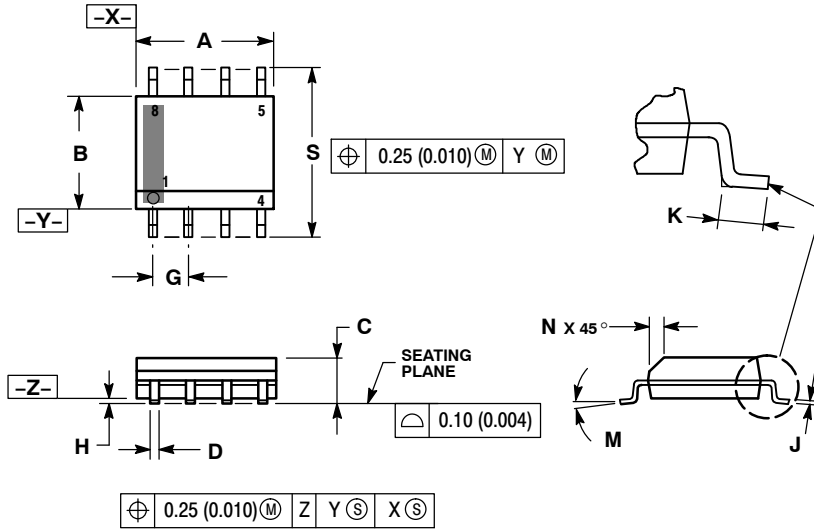

NOTES:

1. DIMENSIONING AND TOLERANCING PER ANSI Y14.5M, 1982.
2. CONTROLLING DIMENSION: MILLIMETER.
3. DIMENSION A AND B DO NOT INCLUDE MOLD PROTRUSION.
4. MAXIMUM MOLD PROTRUSION 0.15 (0.006) PER SIDE.
5. DIMENSION D DOES NOT INCLUDE DAMBAR PROTRUSION. ALLOWABLE DAMBAR PROTRUSION SHALL BE 0.127 (0.005) TOTAL IN EXCESS OF THE D DIMENSION AT MAXIMUM MATERIAL CONDITION.
6. 751-01 THRU 751-06 ARE OBSOLETE. NEW STANDARD IS 751-07.

DIM	MILLIMETERS		INCHES	
	MIN	MAX	MIN	MAX
A	4.80	5.00	0.189	0.197
B	3.80	4.00	0.150	0.157
C	1.35	1.75	0.053	0.069
D	0.33	0.51	0.013	0.020
G	1.27 BSC		0.050 BSC	
H	0.10	0.25	0.004	0.010
J	0.19	0.25	0.007	0.010
K	0.40	1.27	0.016	0.050
M	0°	8°	0°	8°
N	0.25	0.50	0.010	0.020
S	5.80	6.20	0.228	0.244

SOLDERING FOOTPRINT*

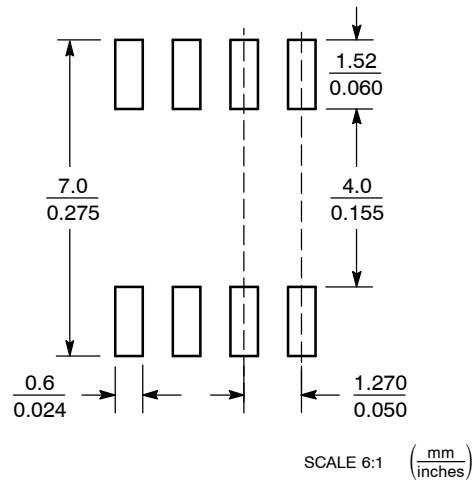

*For additional information on our Pb-Free strategy and soldering details, please download the ON Semiconductor Soldering and Mounting Techniques Reference Manual, SOLDERRM/D.

MC78L00A Series, NCV78L00A

PACKAGE DIMENSIONS

TO-92 (TO-226)
P SUFFIX
CASE 29-11
ISSUE AM

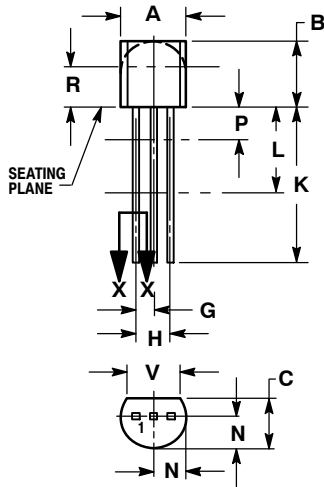

STRAIGHT LEAD
BULK PACK

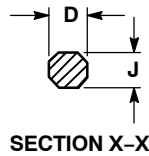

SECTION X-X

NOTES:

1. DIMENSIONING AND TOLERANCING PER ANSI Y14.5M, 1982.
2. CONTROLLING DIMENSION: INCH.
3. CONTOUR OF PACKAGE BEYOND DIMENSION R IS UNCONTROLLED.
4. LEAD DIMENSION IS UNCONTROLLED IN P AND BEYOND DIMENSION K MINIMUM.

DIM	INCHES		MILLIMETERS	
	MIN	MAX	MIN	MAX
A	0.175	0.205	4.45	5.20
B	0.170	0.210	4.32	5.33
C	0.125	0.165	3.18	4.19
D	0.016	0.021	0.407	0.533
G	0.045	0.055	1.15	1.39
H	0.095	0.105	2.42	2.66
J	0.015	0.020	0.39	0.50
K	0.500	---	12.70	---
L	0.250	---	6.35	---
N	0.080	0.105	2.04	2.66
P	---	0.100	---	2.54
R	0.115	---	2.93	---
V	0.135	---	3.43	---

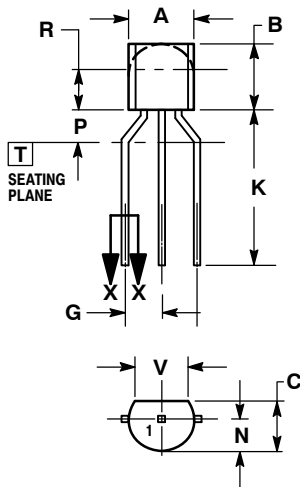

BENT LEAD
TAPE & REEL
AMMO PACK

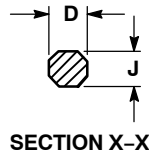

SECTION X-X

NOTES:

1. DIMENSIONING AND TOLERANCING PER ASME Y14.5M, 1994.
2. CONTROLLING DIMENSION: MILLIMETERS.
3. CONTOUR OF PACKAGE BEYOND DIMENSION R IS UNCONTROLLED.
4. LEAD DIMENSION IS UNCONTROLLED IN P AND BEYOND DIMENSION K MINIMUM.

DIM	MILLIMETERS	
	MIN	MAX
A	4.45	5.20
B	4.32	5.33
C	3.18	4.19
D	0.40	0.54
G	2.40	2.80
J	0.39	0.50
K	12.70	---
N	2.04	2.66
P	1.50	4.00
R	2.93	---
V	3.43	---

ON Semiconductor and are registered trademarks of Semiconductor Components Industries, LLC (SCILLC). SCILLC reserves the right to make changes without further notice to any products herein. SCILLC makes no warranty, representation or guarantee regarding the suitability of its products for any particular purpose, nor does SCILLC assume any liability arising out of the application or use of any product or circuit, and specifically disclaims any and all liability, including without limitation special, consequential or incidental damages. "Typical" parameters which may be provided in SCILLC data sheets and/or specifications can and do vary in different applications and actual performance may vary over time. All operating parameters, including "Typicals" must be validated for each customer application by customer's technical experts. SCILLC does not convey any license under its patent rights nor the rights of others. SCILLC products are not designed, intended, or authorized for use as components in systems intended for surgical implant into the body, or other applications intended to support or sustain life, or for any other application in which the failure of the SCILLC product could create a situation where personal injury or death may occur. Should Buyer purchase or use SCILLC products for any such unintended or unauthorized application, Buyer shall indemnify and hold SCILLC and its officers, employees, subsidiaries, affiliates, and distributors harmless against all claims, costs, damages, and expenses, and reasonable attorney fees arising out of, directly or indirectly, any claim of personal injury or death associated with such unintended or unauthorized use, even if such claim alleges that SCILLC was negligent regarding the design or manufacture of the part. SCILLC is an Equal Opportunity/Affirmative Action Employer. This literature is subject to all applicable copyright laws and is not for resale in any manner.

PUBLICATION ORDERING INFORMATION

LITERATURE FULFILLMENT:

Literature Distribution Center for ON Semiconductor
P.O. Box 5163, Denver, Colorado 80217 USA
Phone: 303-675-2175 or 800-344-3860 Toll Free USA/Canada
Fax: 303-675-2176 or 800-344-3867 Toll Free USA/Canada
Email: orderlit@onsemi.com

N. American Technical Support: 800-282-9855 Toll Free
USA/Canada
Europe, Middle East and Africa Technical Support:
Phone: 421 33 790 2910
Japan Customer Focus Center
Phone: 81-3-5773-3850

ON Semiconductor Website: www.onsemi.com

Order Literature: <http://www.onsemi.com/orderlit>

For additional information, please contact your local Sales Representative

MC78L00A/D