

32K x 8 Static RAM

Features

- High speed
 - 12 ns
- Fast t_{DOE}
- CMOS for optimum speed/power
- Low active power
 - 495 mW (Max, "L" version)
- Low standby power
 - 0.275 mW (Max, "L" version)
- 2V data retention ("L" version only)
- Easy memory expansion with \overline{CE} and \overline{OE} features
- TTL-compatible inputs and outputs
- Automatic power-down when deselected
- Available in pb-free 28-pin TSOP I and 28-pin (300-Mil) Molded DIP

Functional Description

The CY7C199 is a high-performance CMOS static RAM organized as 32,768 words by 8 bits. Easy memory expansion is provided by an active LOW Chip Enable (\overline{CE}) and active LOW Output Enable (\overline{OE}) and tri-state drivers. This device has an automatic power-down feature, reducing the power consumption by 81% when deselected. The CY7C199 is in the standard 300-mil-wide DIP, SOJ, and LCC packages.

An active LOW Write Enable signal (\overline{WE}) controls the writing/reading operation of the memory. When \overline{CE} and \overline{WE} inputs are both LOW, data on the eight data input/output pins (I/O_0 through I/O_7) is written into the memory location addressed by the address present on the address pins (A_0 through A_{14}). Reading the device is accomplished by selecting the device and enabling the outputs, \overline{CE} and \overline{OE} active LOW, while \overline{WE} remains inactive or HIGH. Under these conditions, the contents of the location addressed by the information on address pins are present on the eight data input/output pins.

The input/output pins remain in a high-impedance state unless the chip is selected, outputs are enabled, and Write Enable (\overline{WE}) is HIGH. A die coat is used to improve alpha immunity.

Logic Block Diagram

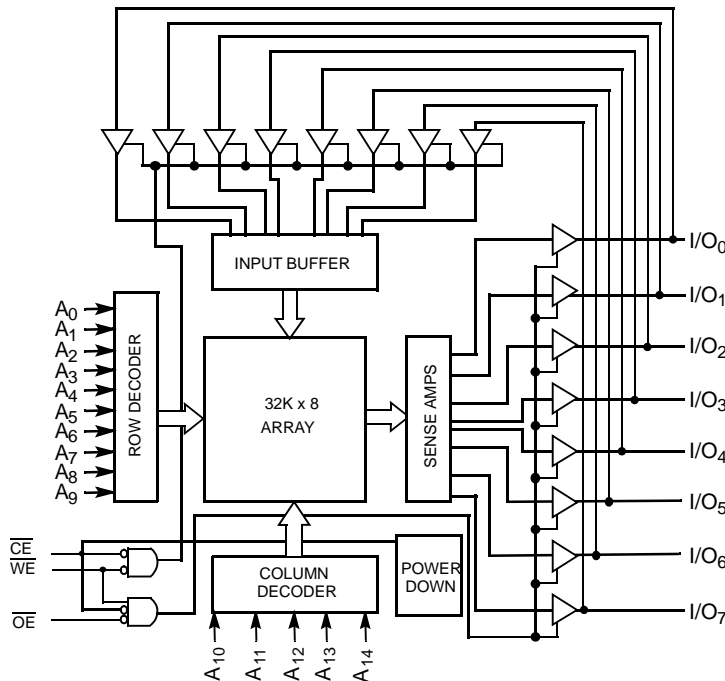

Pin Configurations

DIP
Top View

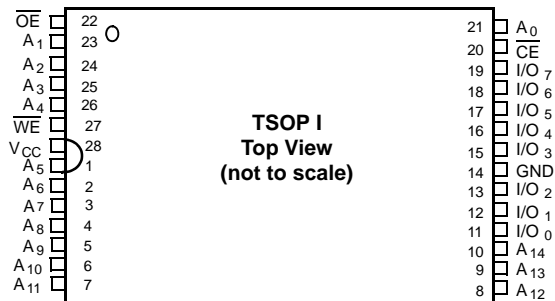
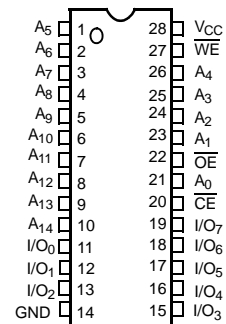

Selection Guide

	-12	-15	-20	Unit
Maximum Access Time	12	15	20	ns
Maximum Operating Current	160	155	150	mA
	L	90		
Maximum CMOS Standby Current	10	10	10	mA
	L	0.05		

Maximum Ratings

(Above which the useful life may be impaired. For user guidelines, not tested.)

Storage Temperature	-65°C to +150°C
Ambient Temperature with Power Applied	-55°C to +125°C
Supply Voltage to Ground Potential (Pin 28 to Pin 14)	-0.5V to +7.0V
DC Voltage Applied to Outputs in High-Z State ^[1]	-0.5V to $V_{CC} + 0.5V$

DC Input Voltage ^[1]	-0.5V to $V_{CC} + 0.5V$
Output Current into Outputs (LOW)	20 mA
Static Discharge Voltage	> 2001V (per MIL-STD-883, Method 3015)
Latch-up Current	> 200 mA

Operating Range

Range	Ambient Temperature ^[2]	V_{CC}
Commercial	0°C to +70°C	5V ± 10%

Electrical Characteristics Over the Operating Range ^[3]

Parameter	Description	Test Conditions	-12		-15		-20		Unit	
			Min.	Max.	Min.	Max.	Min.	Max.		
V_{OH}	Output HIGH Voltage	$V_{CC} = \text{Min.}, I_{OH} = -4.0 \text{ mA}$	2.4		2.4		2.4		V	
V_{OL}	Output LOW Voltage	$V_{CC} = \text{Min.}, I_{OL} = 8.0 \text{ mA}$		0.4		0.4		0.4	V	
V_{IH}	Input HIGH Voltage		2.2	$V_{CC} + 0.3V$	2.2	$V_{CC} + 0.3V$	2.2	$V_{CC} + 0.3V$	V	
V_{IL}	Input LOW Voltage		-0.5	0.8	-0.5	0.8	-0.5	0.8	V	
I_{IX}	Input Leakage Current	$GND \leq V_I \leq V_{CC}$	-5	+5	-5	+5	-5	+5	µA	
I_{OZ}	Output Leakage Current	$GND \leq V_O \leq V_{CC}$, Output Disabled	-5	+5	-5	+5	-5	+5	µA	
I_{CC}	V_{CC} Operating Supply Current	$V_{CC} = \text{Max.}, I_{OUT} = 0 \text{ mA}, f = f_{MAX} = 1/t_{RC}$	Com'l		160		155		150	mA
			L				90			mA
I_{SB1}	Automatic CE Power-down Current—TTL Inputs	Max. V_{CC} , $\overline{CE} \geq V_{IH}$, $V_{IN} \geq V_{IH}$ or $V_{IN} \leq V_{IL}$, $f = f_{MAX}$	Com'l		30		30		30	mA
			L				5			mA
I_{SB2}	Automatic CE Power-down Current—CMOS Inputs	Max. V_{CC} , $\overline{CE} \geq V_{CC} - 0.3V$, $V_{IN} \geq V_{CC} - 0.3V$ or $V_{IN} \leq 0.3V$, $f = 0$	Com'l		10		10		10	mA
			L				0.05			mA

Notes:

- $V_{IL}(\text{min.}) = -2.0V$ for pulse durations of less than 20 ns.
- T_A is the "instant on" case temperature.
- See the last page of this specification for Group A subgroup testing information.

Capacitance^[4]

Parameter	Description	Test Conditions	Max.	Unit
C _{IN}	Input Capacitance	T _A = 25°C, f = 1 MHz, V _{CC} = 5.0V	8	pF
C _{OUT}	Output Capacitance		8	pF

AC Test Loads and Waveforms^[5]

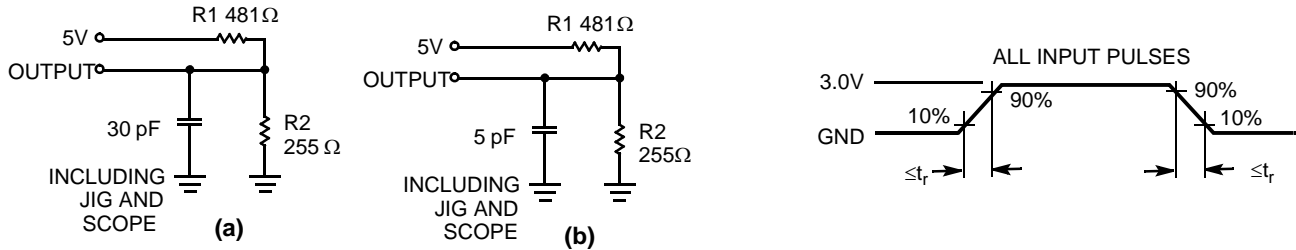

Equivalent to: THÉVENIN EQUIVALENT
 167Ω
 OUTPUT ——— 1.73V

Data Retention Characteristics Over the Operating Range (L-version only)

Parameter	Description	Conditions ^[6]	Min.	Max.	Unit
V _{DR}	V _{CC} for Data Retention		2.0		V
I _{CCDR}	Data Retention Current	V _{CC} = V _{DR} = 2.0V, CE ≥ V _{CC} - 0.3V, V _{IN} ≥ V _{CC} - 0.3V or V _{IN} ≤ 0.3V		10	μA
t _{CDR} ^[4]	Chip Deselect to Data Retention Time		0		ns
t _R ^[5]	Operation Recovery Time		200		μs

Data Retention Waveform

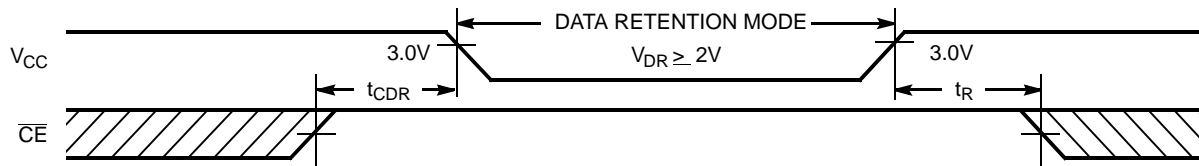

Notes:

- 4. Tested initially and after any design or process changes that may affect these parameters.
- 5. t_R ≤ 3 ns for the -12 and the -15 speeds. t_R ≤ 5 ns for the -20 and slower speeds.
- 6. No input may exceed V_{CC} + 0.5V.

Switching Characteristics Over the Operating Range ^[3,7]

Parameter	Description	-12		-15		-20		Unit
		Min.	Max.	Min.	Max.	Min.	Max.	
Read Cycle								
t_{RC}	Read Cycle Time	12		15		20		ns
t_{AA}	Address to Data Valid		12		15		20	ns
t_{OHA}	Data Hold from Address Change	3		3		3		ns
t_{ACE}	\overline{CE} LOW to Data Valid		12		15		20	ns
t_{DOE}	\overline{OE} LOW to Data Valid		5		7		9	ns
t_{LZOE}	\overline{OE} LOW to Low-Z ^[8]	0		0		0		ns
t_{HZOE}	\overline{OE} HIGH to High-Z ^[8, 9]		5		7		9	ns
t_{LZCE}	\overline{CE} LOW to Low-Z ^[8]	3		3		3		ns
t_{HZCE}	\overline{CE} HIGH to High-Z ^[8, 9]		5		7		9	ns
t_{PU}	\overline{CE} LOW to Power-up	0		0		0		ns
t_{PD}	\overline{CE} HIGH to Power-down		12		15		20	ns
Write Cycle^[10, 11]								
t_{WC}	Write Cycle Time	12		15		20		ns
t_{SCE}	\overline{CE} LOW to Write End	9		10		15		ns
t_{AW}	Address Set-up to Write End	9		10		15		ns
t_{HA}	Address Hold from Write End	0		0		0		ns
t_{SA}	Address Set-up to Write Start	0		0		0		ns
t_{PWE}	\overline{WE} Pulse Width	8		9		15		ns
t_{SD}	Data Set-up to Write End	8		9		10		ns
t_{HD}	Data Hold from Write End	0		0		0		ns
t_{HZWE}	\overline{WE} LOW to High-Z ^[9]		7		7		10	ns
t_{LZWE}	\overline{WE} HIGH to Low-Z ^[8]	3		3		3		ns

Notes:

7. Test conditions assume signal transition time of 3 ns or less for -12 and -15 speeds and 5 ns or less for -20 and slower speeds, timing reference levels of 1.5V, input pulse levels of 0 to 3.0V, and output loading of the specified I_{OL}/I_{OH} and 30-pF load capacitance.
8. At any given temperature and voltage condition, t_{HZCE} is less than t_{LZCE} , t_{HZOE} is less than t_{LZOE} , and t_{HZWE} is less than t_{LZWE} for any given device.
9. t_{HZOE} , t_{HZCE} , and t_{HZWE} are specified with $C_L = 5$ pF as in part (b) of AC Test Loads. Transition is measured ± 500 mV from steady-state voltage.
10. The internal write time of the memory is defined by the overlap of \overline{CE} LOW and \overline{WE} LOW. Both signals must be LOW to initiate a write and either signal can terminate a write by going HIGH. The data input set-up and hold timing should be referenced to the rising edge of the signal that terminates the write.
11. The minimum write cycle time for write cycle #3 (\overline{WE} controlled, \overline{OE} LOW) is the sum of t_{HZWE} and t_{SD} .

Switching Waveforms

Read Cycle No. 1 [12, 13]

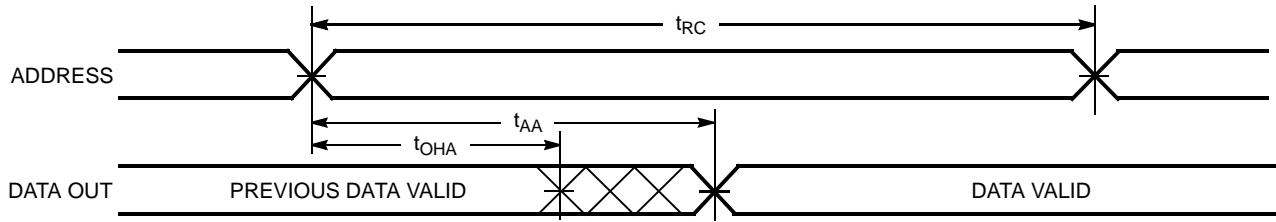

Read Cycle No. 2 [13, 14]

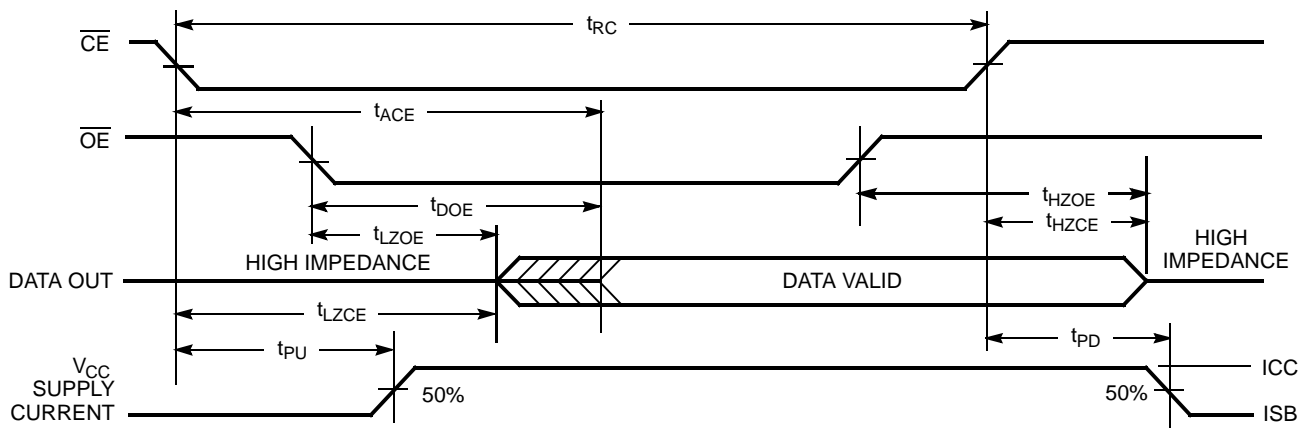

Notes:

- 12. Device is continuously selected. $\overline{OE}, \overline{CE} = V_{IL}$.
- 13. \overline{WE} is HIGH for read cycle.
- 14. Address valid prior to or coincident with \overline{CE} transition LOW.

Switching Waveforms (continued)

Write Cycle No. 1 (\overline{WE} Controlled)^[10, 15, 16]

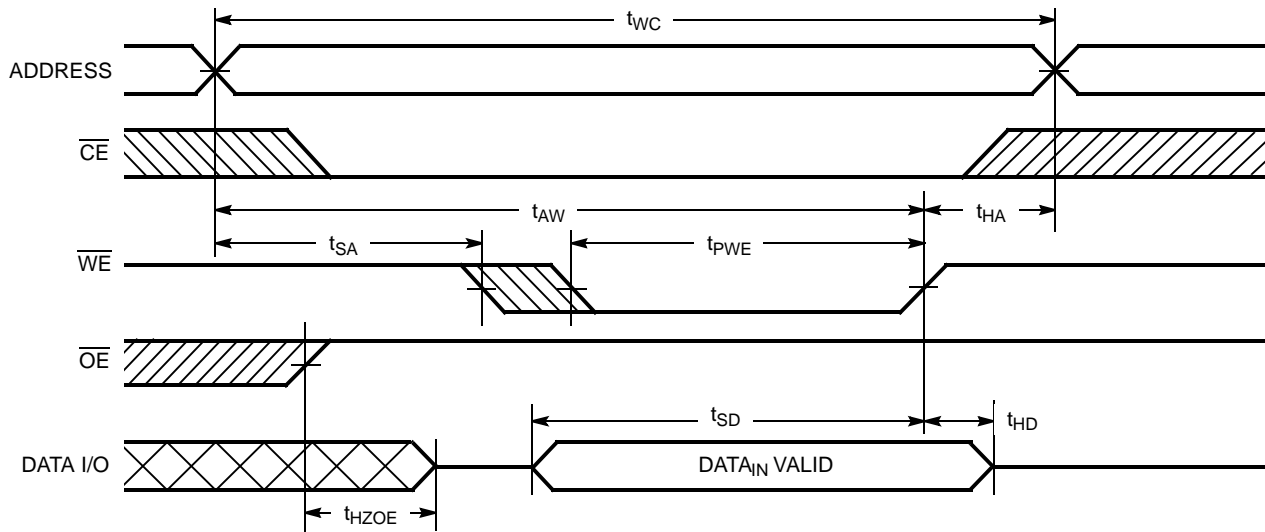

Write Cycle No. 2 (\overline{CE} Controlled)^[10, 15, 16]

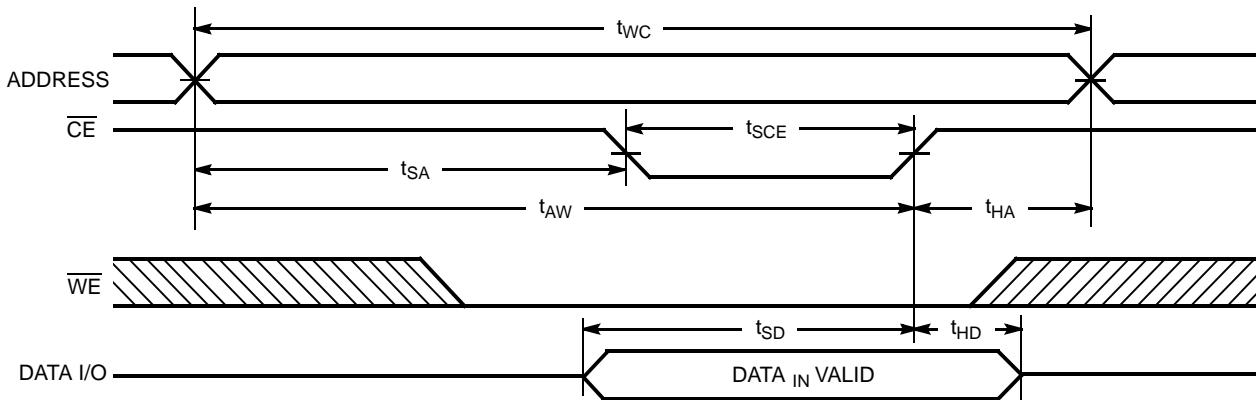

Notes:

- 15. Data I/O is high impedance if $\overline{OE} = V_{IH}$.
- 16. If \overline{CE} goes HIGH simultaneously with \overline{WE} HIGH, the output remains in a high-impedance state.

Switching Waveforms (continued)

Write Cycle No. 3 (\overline{WE} Controlled \overline{OE} LOW)^[11, 16]

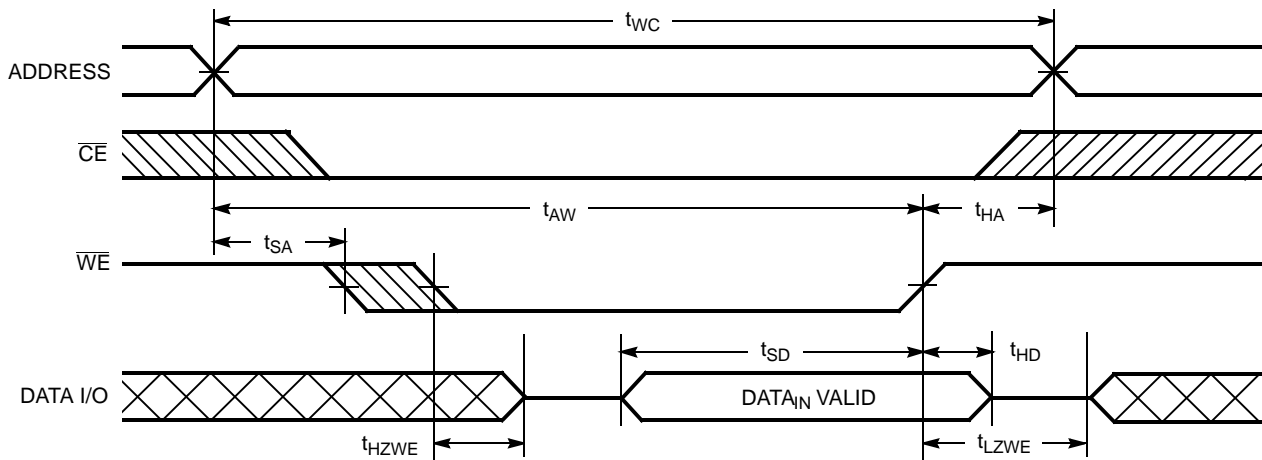

Typical DC and AC Characteristics

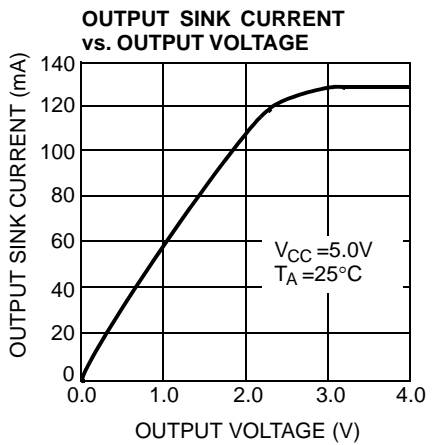
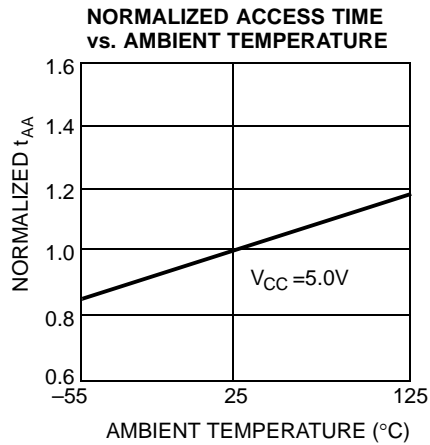
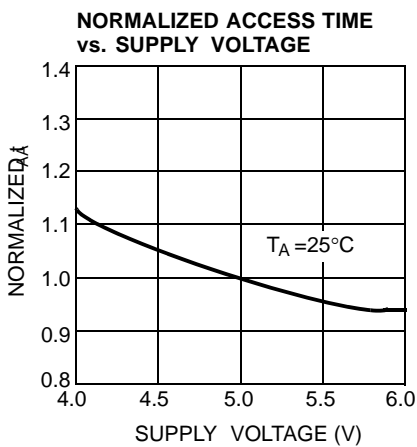
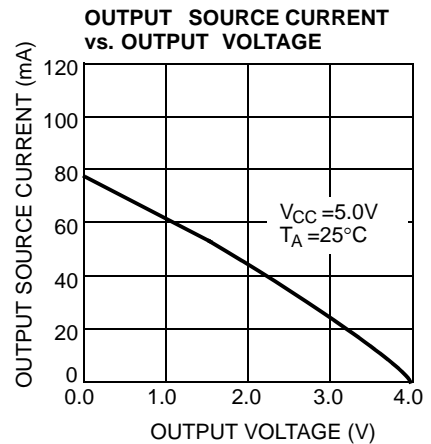
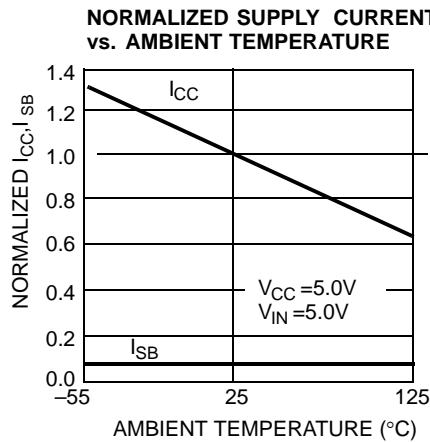
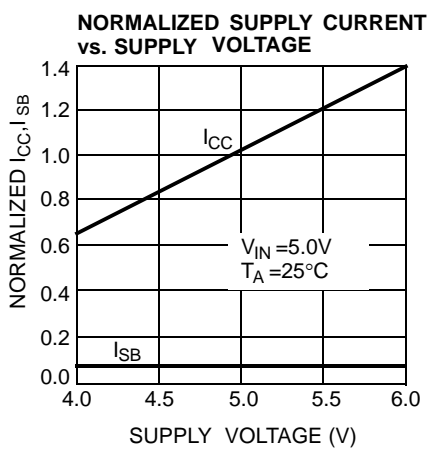

Typical DC and AC Characteristics (continued)

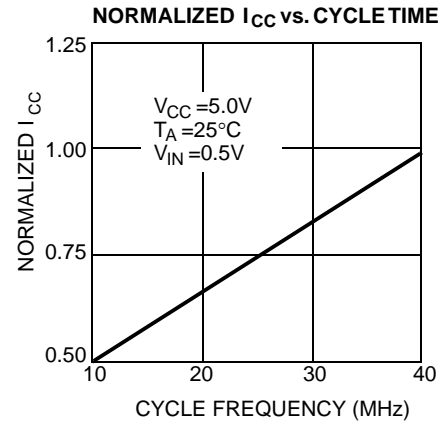
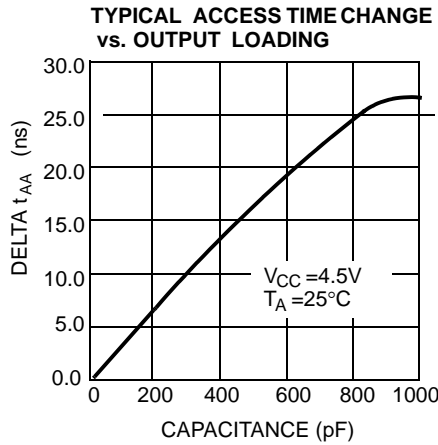
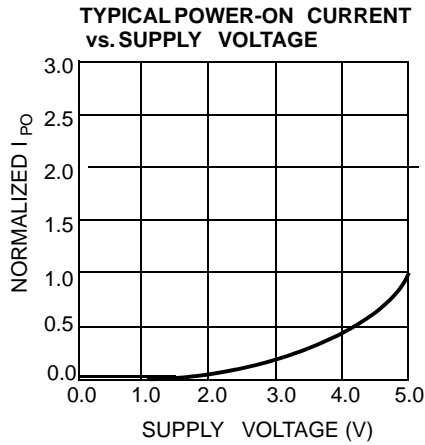

Truth Table

$\overline{\text{CE}}$	$\overline{\text{WE}}$	$\overline{\text{OE}}$	Inputs/Outputs	Mode	Power
H	X	X	High Z	Deselect/Power-down	Standby (I_{SB})
L	H	L	Data Out	Read	Active (I_{CC})
L	L	X	Data In	Write	Active (I_{CC})
L	H	H	High Z	Deselect, Output disabled	Active (I_{CC})

Ordering Information

Speed (ns)	Ordering Code	Package Diagram	Package Type	Operating Range
12	CY7C199-12ZXC	51-85071	28-pin TSOP I (Pb-free)	Commercial
15	CY7C199-15ZXC	51-85071	28-pin TSOP I (Pb-free)	Commercial
	CY7C199L-15ZXC			
20	CY7C199-20PXC	51-85014	28-pin (300-Mil) Molded DIP (Pb-free)	Commercial

Package Diagrams

28-pin (300-Mil) PDIP (51-85014)

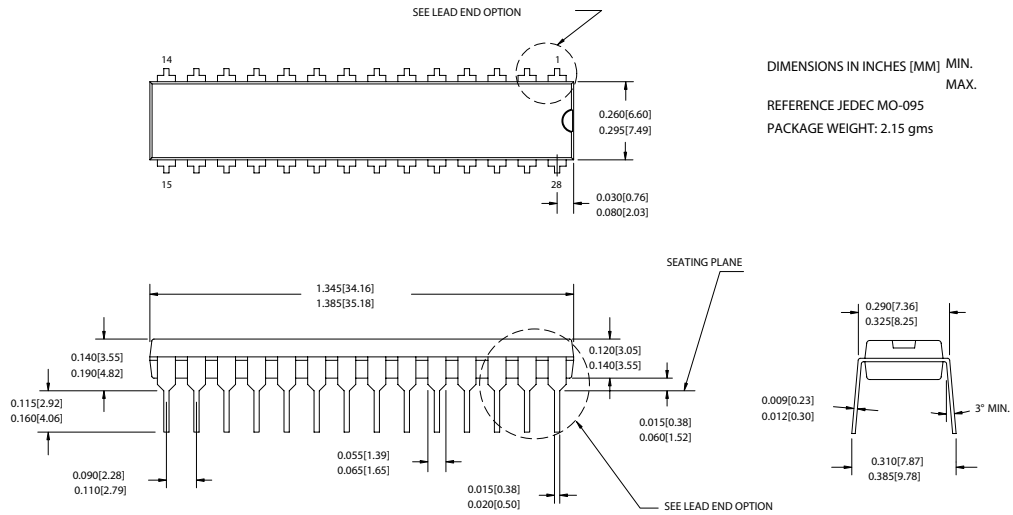

LEAD END OPTION
(LEAD #1, 14, 15 & 28)

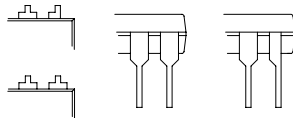

51-85014-*D

Package Diagrams (continued)

28-pin TSOP Type 1 (8x13.4 mm) (51-85071)

NOTE: ORIENTATION I.D. MAY BE LOCATED EITHER AS SHOWN IN OPTION 1 OR OPTION 2

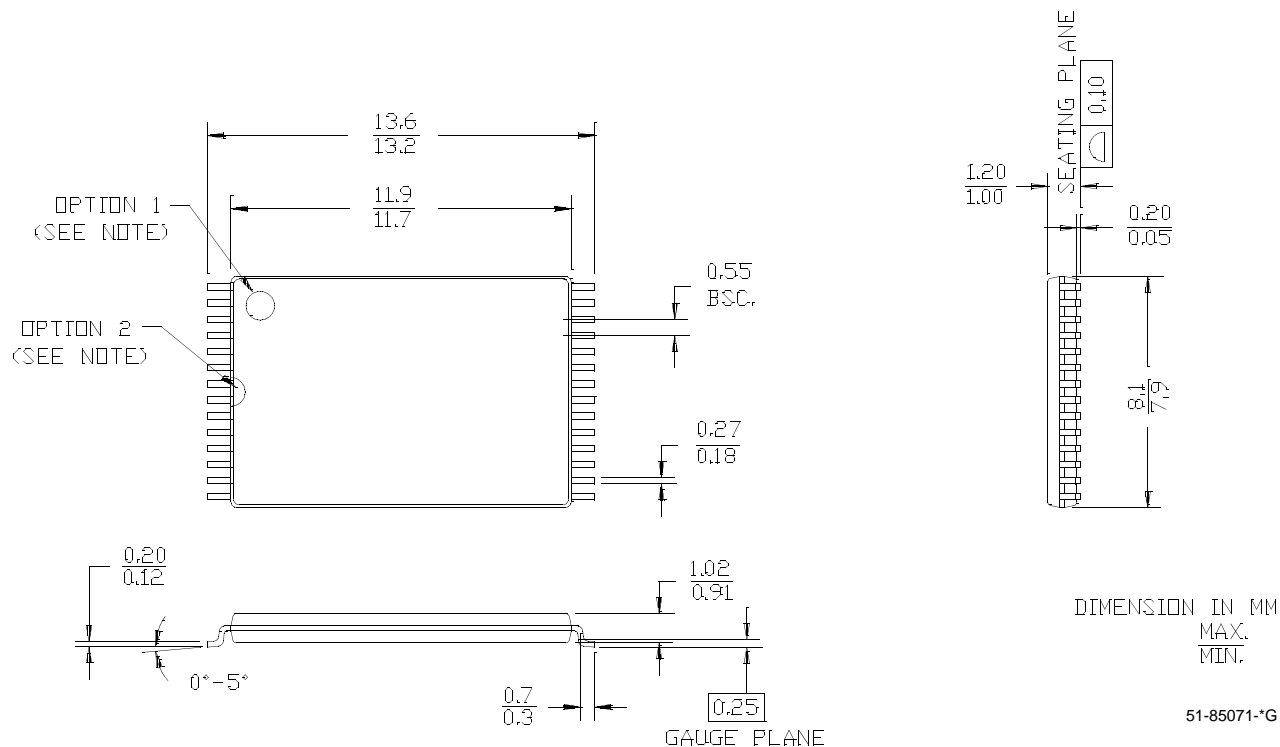

All products and company names mentioned in this document are the trademarks of their respective holders.

Document History Page

Document Title: CY7C199 32K x 8 Static RAM Document Number: 38-05160				
REV.	ECN NO.	Issue Date	Orig. of Change	Description of Change
**	109971	10/28/01	SZV	Change from Spec number: 38-00239 to 38-05160
*A	121730	01/09/02	DFP	Updated Product Offering table
*B	492500	See ECN	NXR	Removed 8 ns, 10 ns, 25 ns , 35 ns, 45 ns speed bins Removed 28-Lead (300-Mil) CerDIP, 28-Pin Rectangular Leadless Chip Carrier, 28-Lead Molded SOIC, 28-Lead Molded SOJ packages from product offering Changed the description of I_{IX} from Input Load Current to Input Leakage Current in DC Electrical Characteristics table Removed I_{OS} parameter from DC Electrical Characteristics Table Updated Ordering Information Table