

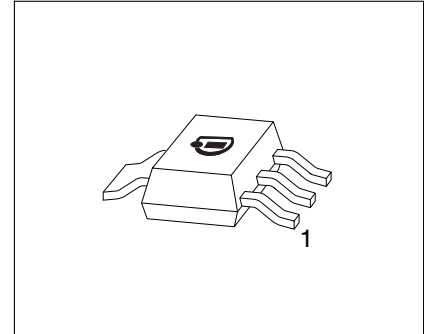

- High-side switch
- Short-circuit protection
- Input protection
- Overtemperature protection with hysteresis
- Overload protection
- Overvoltage protection
- Switching inductive load
- Clamp of negative output voltage with inductive loads
- Undervoltage shutdown
- Maximum current internally limited
- **Electrostatic discharge (ESD)** protection
- Reverse battery protection¹⁾
- AEC qualified
- Green product (RoHS compliant)



PG-SOT-223

Application

- μ C compatible power switch for 12 V DC grounded loads
- All types of resistive, inductive and capacitive loads
- Replaces electromechanical relays and discrete circuits

General Description

N channel vertical power FET with charge pump, ground referenced CMOS compatible input, monolithically integrated in Smart SIPMOS[®] technology. Fully protected by embedded protection functions.

Blockdiagramm:

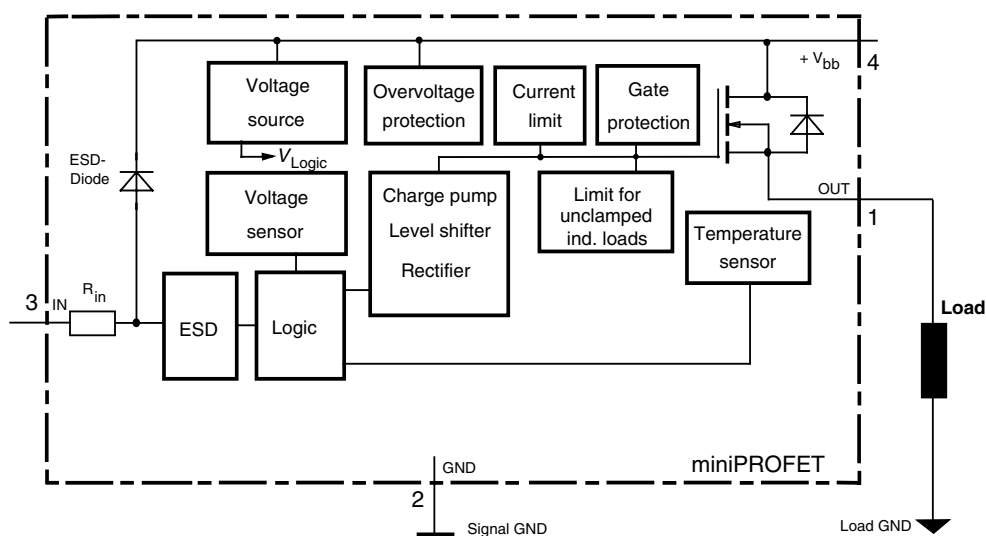

¹⁾ With resistor $R_{GND}=150 \Omega$ in GND connection, resistor in series with IN connections reverse load current limited by connected load.

Pin	Symbol	Function
1	OUT ○	Output to the load
2	GND -	Logic ground
3	IN	Input, activates the power switch in case of logical high signal
4	V _{bb} +	Positive power supply voltage

Maximum Ratings at $T_j = 25\text{ °C}$ unless otherwise specified

Parameter	Symbol	Values	Unit
Supply voltage	V_{bb}	40	V
Load current self-limited	I_L	$I_{L(SC)}$	A
Maximum input voltage ²⁾	V_{IN}	-5.0... V_{bb}	V
Maximum input current	I_{IN}	±5	mA
Inductive load switch-off energy dissipation, single pulse $I_L = 0.5\text{A}$, $T_A = 150\text{°C}$ (not tested, specified by design)	E_{AS}	0.5	J
Load dump protection ³⁾ $V_{LoadDump} = U_A + V_S$ $R_L = 24\Omega$ $R_I = 2\Omega$, $t_d = 400\text{ms}$, IN = low or high, $U_A = 13.5\text{V}$ $R_L = 80\Omega$ (not tested, specified by design)	$V_{Load\ dump}^{4)}$	60 80	V
Electrostatic discharge capability (ESD) ⁵⁾ PIN 3 PIN 1,2,4	V_{ESD}	±1 ±2	kV
Operating temperature range	T_j	-40 ... +150	°C
Storage temperature range	T_{stg}	-55 ... +150	°C
Max. power dissipation (DC) ⁶⁾ $T_A = 25\text{ °C}$	P_{tot}	1.8	W
Thermal resistance chip - soldering point:	R_{thJS}	7	K/W
chip - ambient: ⁶⁾	R_{thJA}	70	

²⁾ At $V_{IN} > V_{bb}$, the input current is not allowed to exceed ±5 mA.

³⁾ Supply voltages higher than $V_{bb(AZ)}$ require an external current limit for the GND pin, e.g. with a 150 Ω resistor in the GND connection. A resistor for the protection of the input is integrated.

⁴⁾ $V_{Load\ dump}$ is setup without the DUT connected to the generator per ISO 7637-1 and DIN 40839

⁵⁾ HBM according to MIL-STD 883D, Methode 3015.7

⁶⁾ BSP 452 on epoxy pcb 40 mm x 40 mm x 1.5 mm with 6 cm² copper area for V_{bb} connection

Electrical Characteristics

Parameter and Conditions at $T_j = 25\text{ }^\circ\text{C}$, $V_{bb} = 13.5\text{V}$ unless otherwise specified	Symbol	Values			Unit
		min	typ	max	

Load Switching Capabilities and Characteristics

On-state resistance (pin 4 to 1) $I_L = 0.5\text{ A}$, $V_{in} = \text{high}$	$T_j = 25\text{ }^\circ\text{C}$ $T_j = 150\text{ }^\circ\text{C}$	R_{ON}	-- --	0.16 --	0.2 0.4	Ω
Nominal load current (pin 4 to 1) ⁷⁾ ISO Standard: $V_{ON} = V_{bb} - V_{OUT} = 0.5\text{ V}$ $T_S = 85\text{ }^\circ\text{C}$		$I_{L(ISO)}$	0.7	--	--	A
Turn-on time Turn-off time $R_L = 24\text{ }\Omega$	to 90% V_{OUT} to 10% V_{OUT}	t_{on} t_{off}	-- --	60 60	100 150	μs
Slew rate on 10 to 30% V_{OUT} , $R_L = 24\text{ }\Omega$		dV/dt_{on}	--	2	4	$\text{V}/\mu\text{s}$
Slew rate off 70 to 40% V_{OUT} , $R_L = 24\text{ }\Omega$		$-dV/dt_{off}$	--	2	4	$\text{V}/\mu\text{s}$

Input

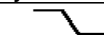
Allowable input voltage range, (pin 3 to 2)		V_{IN}	-3.0	--	V_{bb}	V
Input turn-on threshold voltage  $T_j = -40\dots+150\text{ }^\circ\text{C}$		$V_{IN(T+)}$	--	--	3.5	V
Input turn-off threshold voltage  $T_j = -40\dots+150\text{ }^\circ\text{C}$		$V_{IN(T-)}$	1.5	--	--	V
Input threshold hysteresis		$\Delta V_{IN(T)}$	--	0.5	--	V
Off state input current (pin 3) $V_{IN(off)} = 1.2\text{ V}$ $T_j = -40\dots+150\text{ }^\circ\text{C}$		$I_{IN(off)}$	10	--	60	μA
On state input current (pin 3) $V_{IN(on)} = 3.0\text{ V to } V_{bb}$ $T_j = -40\dots+150\text{ }^\circ\text{C}$		$I_{IN(on)}$	10	--	100	μA
Input resistance		R_{IN}	1.5	2.8	3.5	$\text{k}\Omega$

⁷⁾ $I_{L(ISO)}$ is limited by current limitation, see $I_{L(SC)}$, next page

Parameter and Conditions at $T_j = 25^\circ\text{C}$, $V_{bb} = 13.5\text{V}$ unless otherwise specified	Symbol	Values			Unit	
		min	typ	max		
Operating Parameters						
Operating voltage ⁸⁾	$T_j = -40\dots+150^\circ\text{C}$	$V_{bb(\text{on})}$	5.0	--	34	V
Undervoltage shutdown	$T_j = -40\dots+150^\circ\text{C}$	$V_{bb(\text{under})}$	3.5	--	5	V
Undervoltage restart	$T_j = -40\dots+25^\circ\text{C}$ $T_j = +150^\circ\text{C}$	$V_{bb(\text{u rst})}$	--	--	6.5 7.0	V
Undervoltage restart of charge pump see diagram page 7		$V_{bb(\text{ucp})}$	--	5.6	7	V
Undervoltage hysteresis $\Delta V_{bb(\text{under})} = V_{bb(\text{u rst})} - V_{bb(\text{under})}$		$\Delta V_{bb(\text{under})}$	--	0.3	--	V
Overvoltage shutdown	$T_j = -40\dots+150^\circ\text{C}$	$V_{bb(\text{over})}$	34	--	42	V
Overvoltage restart	$T_j = -40\dots+150^\circ\text{C}$	$V_{bb(\text{o rst})}$	33	--	--	V
Overvoltage hysteresis	$T_j = -40\dots+150^\circ\text{C}$	$\Delta V_{bb(\text{over})}$	--	0.7	--	V
Standby current (pin 4), $V_{in} = \text{low}$	$T_j = -40\dots+150^\circ\text{C}$	$I_{bb(\text{off})}$	--	10	25	μA
Operating current (pin 2), $V_{in} = 5\text{V}$		I_{GND}	--	1	1.6	mA
leakage current (pin 1) $V_{in} = \text{low}$	$T_j = -40\dots+25^\circ\text{C}$ $T_j = 150^\circ\text{C}$	$I_{L(\text{off})}$	--	2	5 7	μA

Protection Functions

Current limit (pin 4 to 1) $V_{bb} = 20\text{V}$	$T_j = 25^\circ\text{C}$ $T_j = -40\dots+150^\circ\text{C}$	$I_L(\text{SC})$	0.7 0.7	1.5 --	2 2.4	A
Overvoltage protection $I_{bb}=4\text{mA}$	$T_j = -40\dots+150^\circ\text{C}$	$V_{bb(\text{AZ})}$	41	--	--	V
Output clamp (ind. load switch off) at $V_{\text{OUT}}=V_{bb}-V_{\text{ON}(\text{CL})}$, $I_{bb} = 4\text{mA}$		$V_{\text{ON}(\text{CL})}$	41	47	--	V
Thermal overload trip temperature		T_{jt}	150	--	--	$^\circ\text{C}$
Thermal hysteresis		ΔT_{jt}	--	10	--	K
Inductive load switch-off energy dissipation ⁹⁾ $T_{j \text{ Start}} = 150^\circ\text{C}$, single pulse, $I_L = 0.5\text{A}$, $V_{bb} = 12\text{V}$ (not tested, specified by design)		E_{AS}	--	--	0.5	J
Reverse battery (pin 4 to 2) ¹⁰⁾ (not tested, specified by design)		$-V_{bb}$	--	--	30	V

⁸⁾ At supply voltage increase up to $V_{bb}=5.6\text{V}$ typ without charge pump, $V_{\text{OUT}} \approx V_{bb} - 2\text{V}$

⁹⁾ While demagnetizing load inductance, dissipated energy in PROFET is $E_{\text{AS}} = \int V_{\text{ON}(\text{CL})} \cdot i_L(t) dt$, approx.

$$E_{\text{AS}} = \frac{1}{2} \cdot L \cdot I_L^2 \cdot \left(\frac{V_{\text{ON}(\text{CL})}}{V_{\text{ON}(\text{CL})} - V_{bb}} \right)$$

¹⁰⁾ Requires $150\ \Omega$ resistor in GND connection. Reverse load current (through intrinsic drain-source diode) is normally limited by the connected load.

Max. allowable power dissipation

$$P_{tot} = f(T_A, T_{SP})$$

P_{tot} [W]

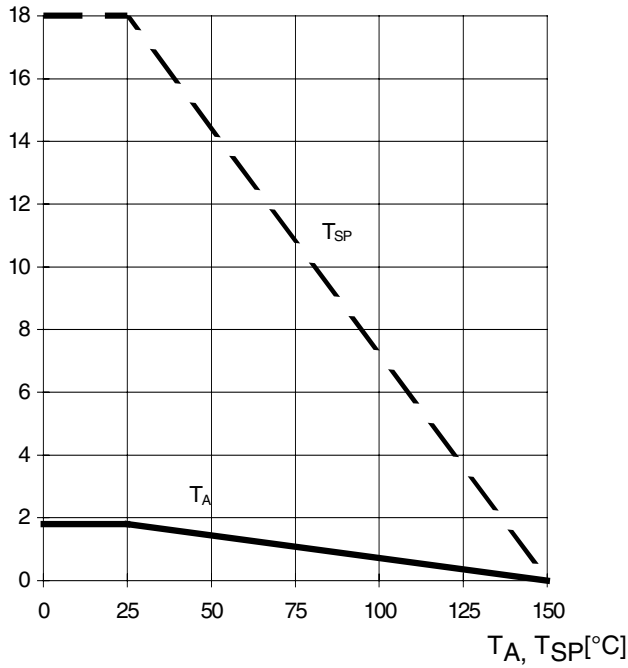

Current limit characteristic

$$I_{L(SC)} = f(V_{on}); (V_{on} \text{ see testcircuit})$$

$I_{L(SC)}$ [A]

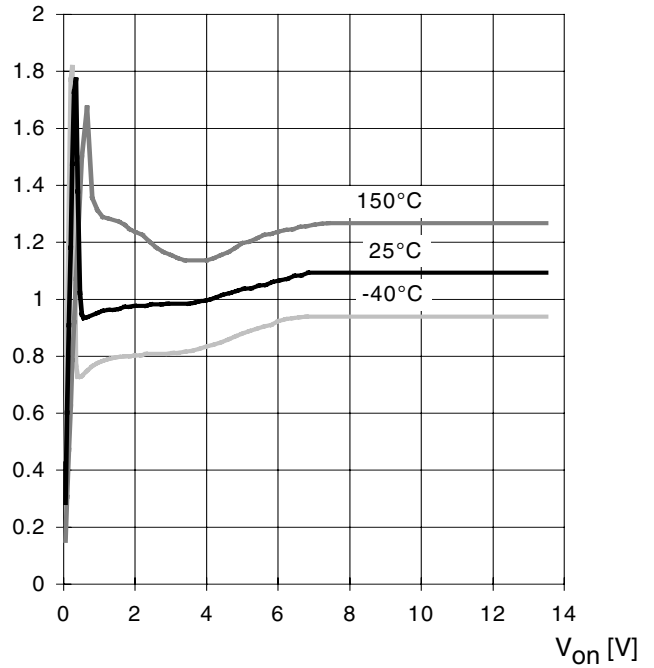

On state resistance (Vbb-pin to OUT-pin)

$$R_{ON} = f(T_j); V_{bb} = 13.5 \text{ V}; I_L = 0.5 \text{ A}$$

R_{ON} [Ω]

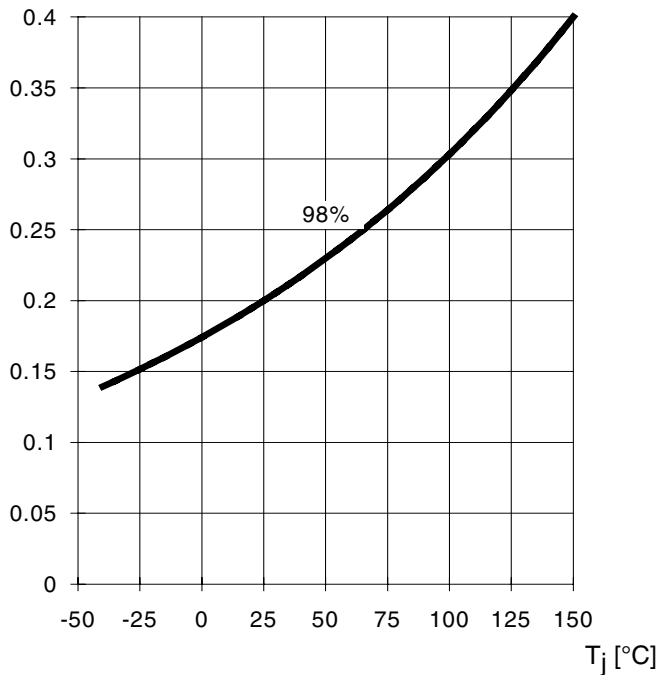

Typ. input current

$$I_{IN} = f(V_{IN}); V_{bb} = 13.5 \text{ V}$$

I_{IN} [μA]

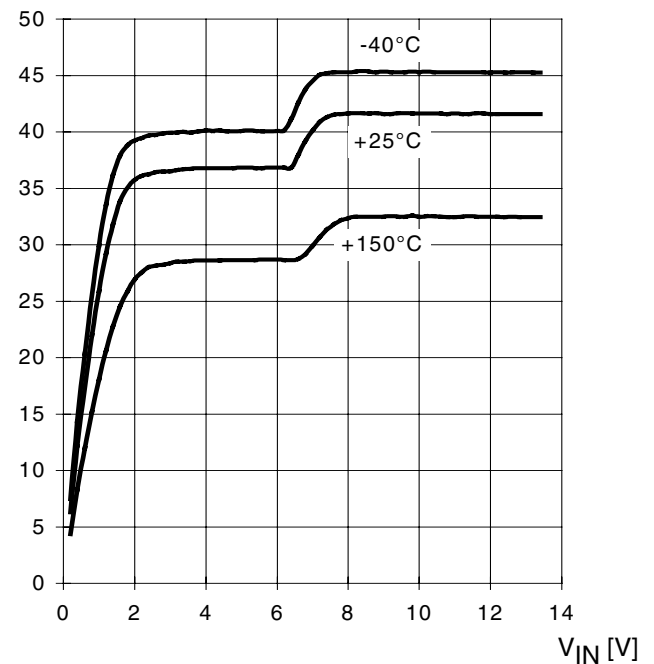

Typ. operating current

$I_{GND} = f(T_j)$; $V_{bb} = 13,5\text{ V}$; $V_{IN} = \text{high}$

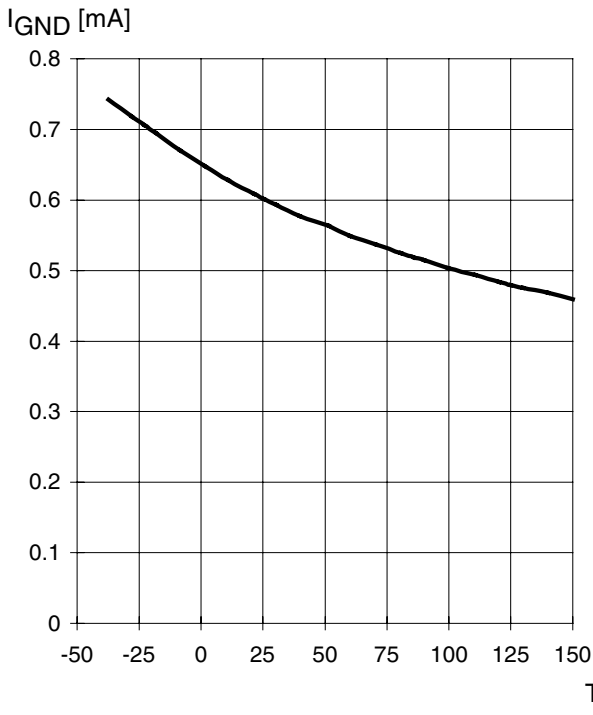

Typ. overload current

$I_{L(\text{lim})} = f(t)$; $V_{bb} = 13,5\text{ V}$, no heatsink, Param.: $T_{j\text{start}}$

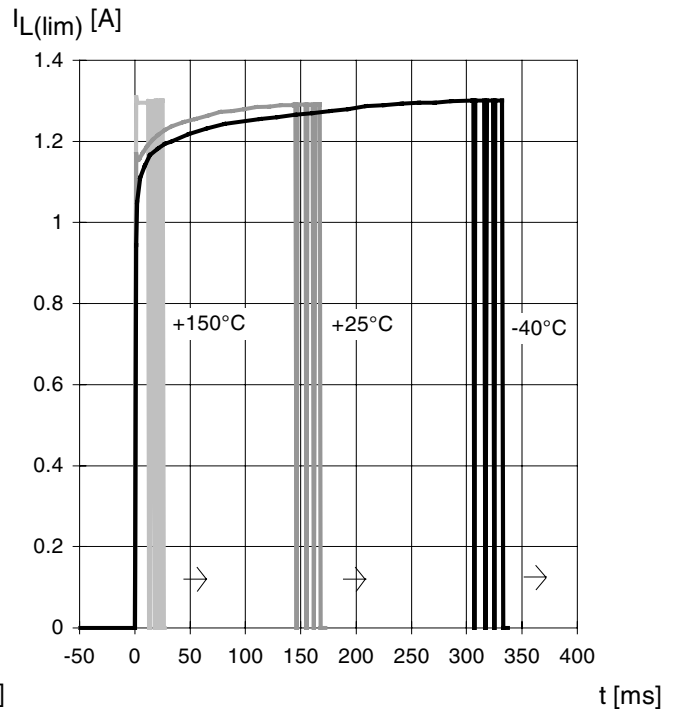

Typ. standby current

$I_{bb(\text{off})} = f(T_j)$; $V_{bb} = 13,5\text{ V}$; $V_{IN} = \text{low}$

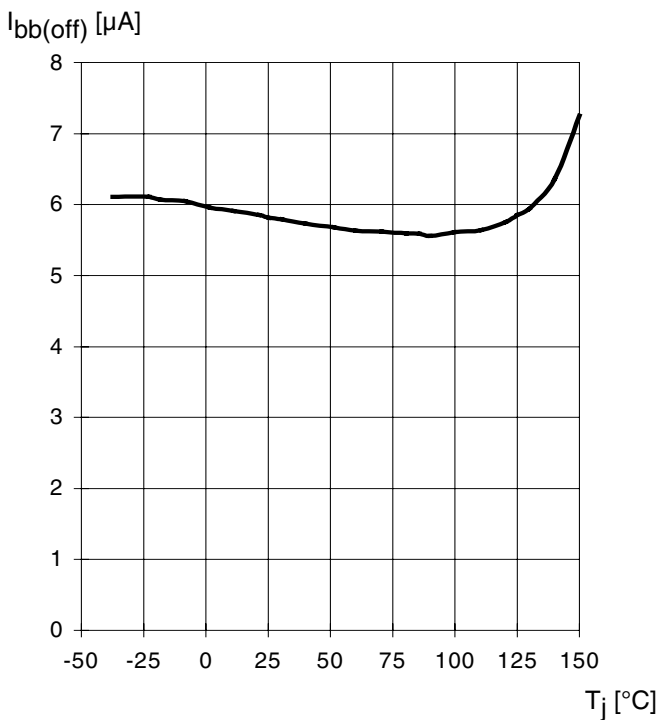

Short circuit current

$I_{L(\text{SC})} = f(T_j)$; $V_{bb} = 13,5\text{ V}$

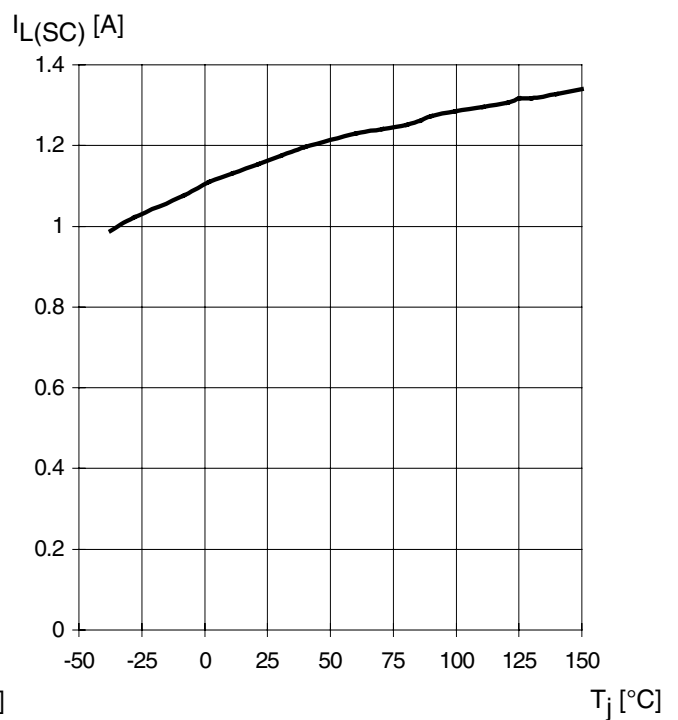

Typ. input turn on voltage threshold
 $V_{IN(T+)} = f(T_j)$;

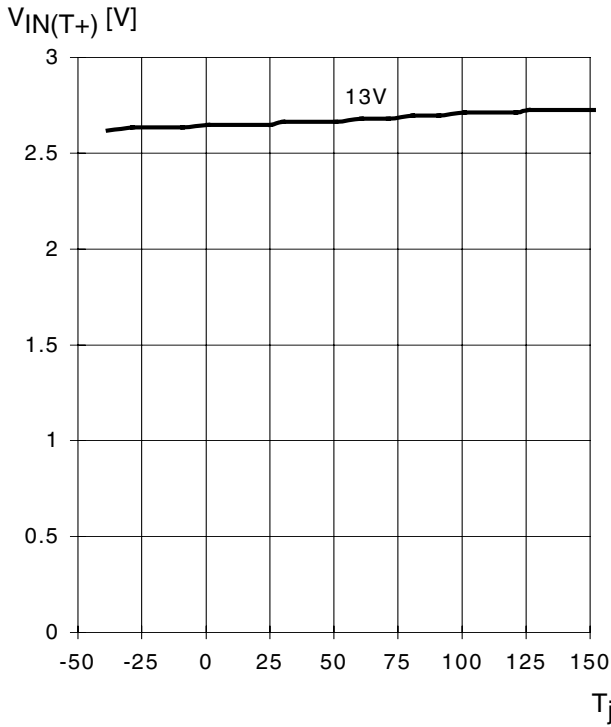
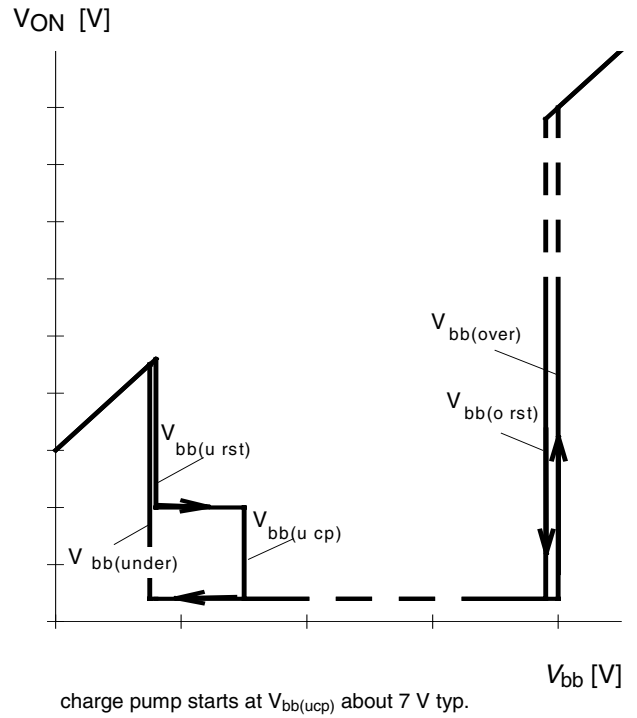
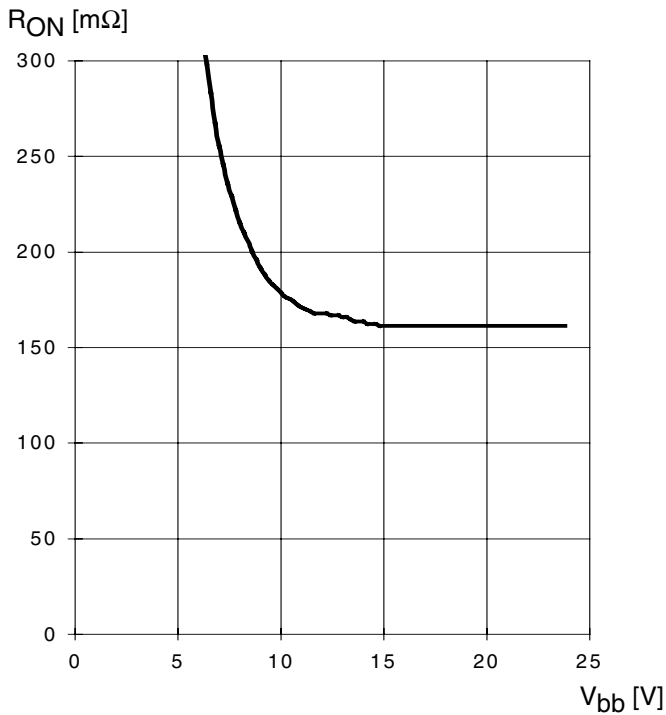

Figure 6: Undervoltage restart of charge pump



Typ. on-state resistance (V_{bb}-Pin to Out-Pin)
 $R_{ON} = f(V_{bb}, I_L)$; $I_L = 0.5A$, $T_j = 25^\circ C$



Test circuit

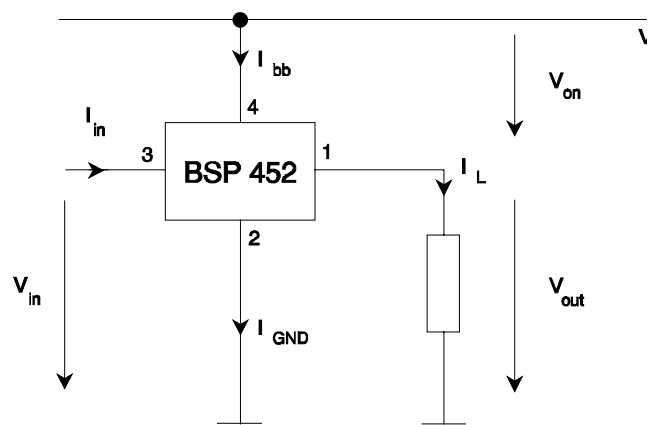

Revision History

Version	Date	Changes
1.0	2007-05-25	Creation of the green datasheet. First page : Adding the green logo and the AEC qualified Adding the bullet AEC qualified and the RoHS compliant features Package page Modification of the package to be green.

Edition 2007-05-25

**Published by
Infineon Technologies AG
81726 Munich, Germany**

**© Infineon Technologies AG 5/29/07.
All Rights Reserved.**

Legal Disclaimer

The information given in this document shall in no event be regarded as a guarantee of conditions or characteristics ("Beschaffenhheitsgarantie"). With respect to any examples or hints given herein, any typical values stated herein and/or any information regarding the application of the device, Infineon Technologies hereby disclaims any and all warranties and liabilities of any kind, including without limitation warranties of non-infringement of intellectual property rights of any third party.

Information

For further information on technology, delivery terms and conditions and prices please contact your nearest Infineon Technologies Office (www.infineon.com).

Warnings

Due to technical requirements components may contain dangerous substances. For information on the types in question please contact your nearest Infineon Technologies Office.

Infineon Technologies Components may only be used in life-support devices or systems with the express written approval of Infineon Technologies, if a failure of such components can reasonably be expected to cause the failure of that life-support device or system, or to affect the safety or effectiveness of that device or system. Life support devices or systems are intended to be implanted in the human body, or to support and/or maintain and sustain and/or protect human life. If they fail, it is reasonable to assume that the health of the user or other persons may be endangered.