

Bipolar Transistor

(-50 V, (-)5 A, Low $V_{CE(sat)}$,
(PNP)NPN Single TP/TP-FA

2SB1203/2SD1803

Features

- Low Collector-to-Emitter Saturation Voltage
- Excellent Linearity of h_{FE}
- Small and Slim Package Making It Easy to Make
2SB1203/2SD1803-Applied Sets Smaller
- High Current and High f_T
- Fast Switching Speed

Applications

- Relay Drivers, High-Speed Inverters, Converters, and Other General High-Current Switching Applications

ABSOLUTE MAXIMUM RATINGS (at $T_a = 25^\circ\text{C}$)

Symbol	Parameter	Condition	Rating	Unit
V_{CBO}	Collector-to-Base Voltage		(-)60	V
V_{CEO}	Collector-to-Emitter Voltage		(-)50	V
V_{EBO}	Emitter-to-Base Voltage		(-)6	V
I_C	Collector Current		(-)5	A
I_{CP}	Collector Current (Pulse)		(-)8	A
P_C	Collector Dissipation		1	W
		$T_c = 25^\circ\text{C}$	20	W
T_j	Junction Temperature		150	$^\circ\text{C}$
T_{stg}	Storage Temperature		-55 to +150	$^\circ\text{C}$

Stresses exceeding those listed in the Maximum Ratings table may damage the device. If any of these limits are exceeded, device functionality should not be assumed, damage may occur and reliability may be affected.



ON Semiconductor®

www.onsemi.com

ELECTRICAL CONNECTION

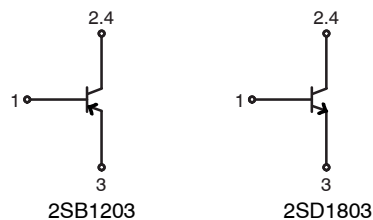

2SB1203

2SD1803

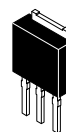

IPAK / TP
CASE 369AJ

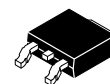

DPAK / TP-FA
CASE 369AH

MARKING DIAGRAM

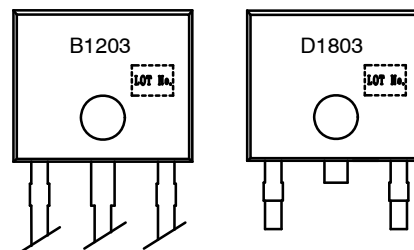

ORDERING INFORMATION

See detailed ordering and shipping information on page 6 of this data sheet.

2SB1203/2SD1803

ELECTRICAL CHARACTERISTICS (at $T_A = 25^\circ\text{C}$)

Symbol	Parameter	Conditions	Min	Typ	Max	Unit
I_{CBO}	Collector Cutoff Current	$V_{CB} = (-)40\text{ V}, I_E = 0\text{ A}$			(-1)	μA
I_{EBO}	Emitter Cutoff Current	$V_{EB} = (-)4\text{ V}, I_C = 0\text{ A}$			(-1)	μA
h_{FE1}	DC Current Gain	$V_{CE} = (-)2\text{ V}, I_C = (-)0.5\text{ A}$	70 (Note 1)		400 (Note 1)	
h_{FE2}		$V_{CE} = (-)2\text{ V}, I_C = (-)4\text{ A}$	35			
f_T	Gain-Bandwidth Product	$V_{CE} = (-)5\text{ V}, I_C = (-)1\text{ A}$		(130)180		MHz
C_{ob}	Output Capacitance	$V_{CB} = (-)10\text{ V}, f = 1\text{ MHz}$		(60)40		pF
$V_{CE(sat)}$	Collector-to-Emitter Saturation Voltage	$I_C = (-)3\text{ A}, I_B = (-)0.15\text{ A}$		(-280)220	(-550)400	mV
$V_{BE(sat)}$	Base-to-Emitter Saturation Voltage	$I_C = (-)3\text{ A}, I_B = (-)0.15\text{ A}$		(-)0.95	(-)1.3	V
$V_{(BR)CBO}$	Collector-to-Base Breakdown Voltage	$I_C = (-)10\text{ }\mu\text{A}, I_E = 0\text{ A}$	(-)60			V
$V_{(BR)CEO}$	Collector-to-Emitter Breakdown Voltage	$I_C = (-)1\text{ mA}, R_{BE} = \infty$	(-)50			V
$V_{(BR)EBO}$	Emitter-to-Base Breakdown Voltage	$I_E = (-)10\text{ }\mu\text{A}, I_C = 0\text{ A}$	(-)6			V
t_{on}	Turn-On Time	See Specified Test Circuit		(50)50		ns
t_{stg}	Storage Time			(450)500		ns
t_f	Fall Time			(20)20		ns

Product parametric performance is indicated in the Electrical Characteristics for the listed test conditions, unless otherwise noted. Product performance may not be indicated by the Electrical Characteristics if operated under different conditions.

1. The 2SB1203/2SD1803 are classified by 0.5 A h_{FE} as follows:

Rank	Q	R	S	T
h_{FE}	70 to 140	100 to 200	140 to 280	200 to 400

Switching Time Test Circuit

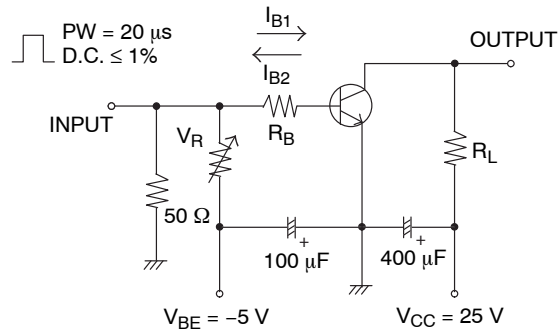

$I_C = 10\text{ A}, I_{B1} = -10\text{ A}, I_{B2} = 2\text{ A}$
 For PNP, the polarity is reversed.

2SB1203/2SD1803

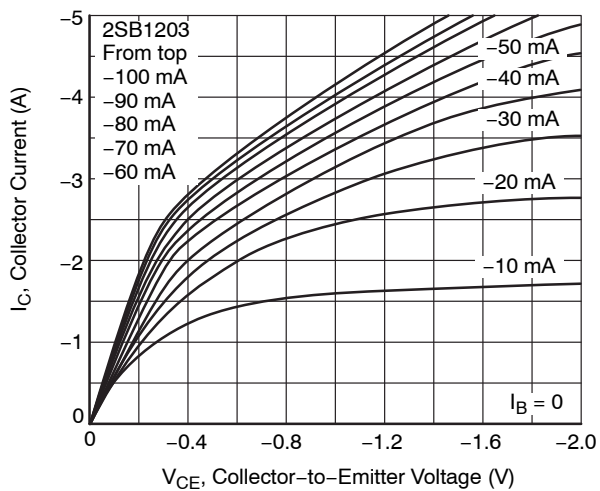

Figure 1. $I_C - V_{CE}$

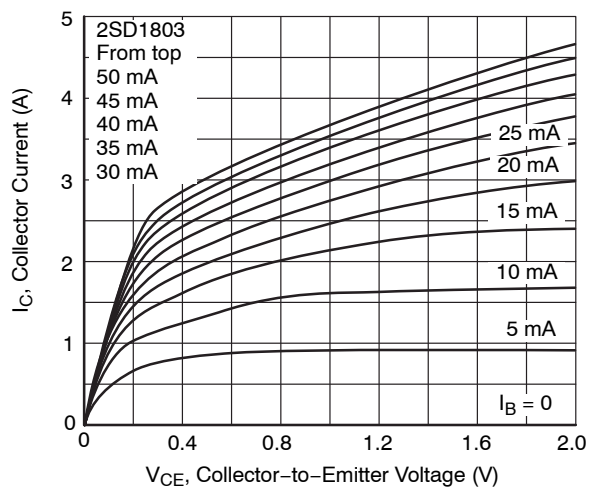

Figure 2. $I_C - V_{CE}$

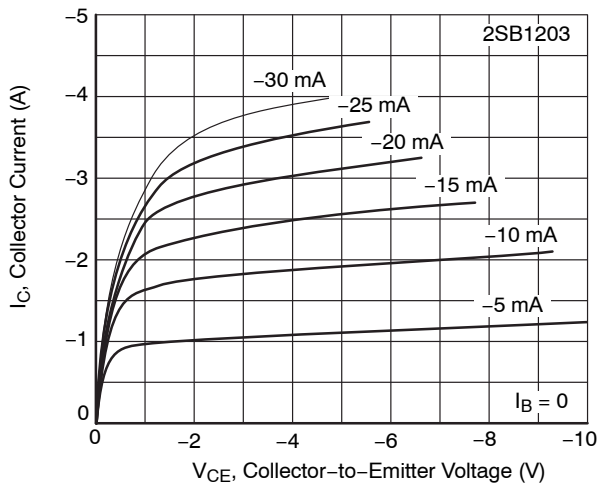

Figure 3. $I_C - V_{CE}$

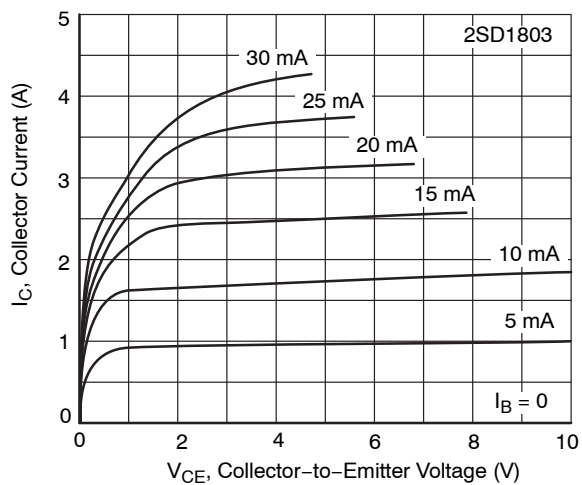

Figure 4. $I_C - V_{CE}$

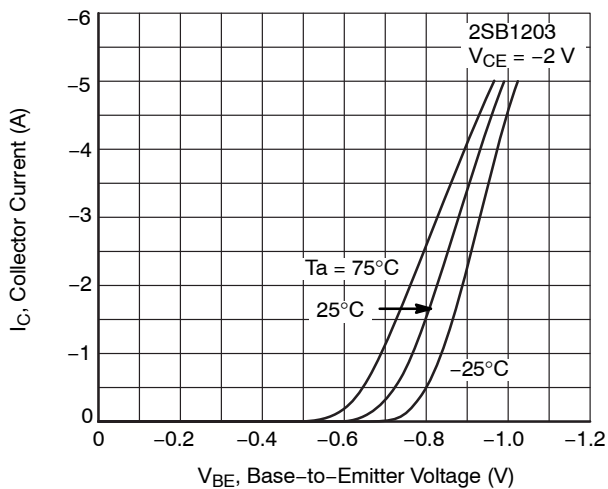

Figure 5. $I_C - V_{BE}$

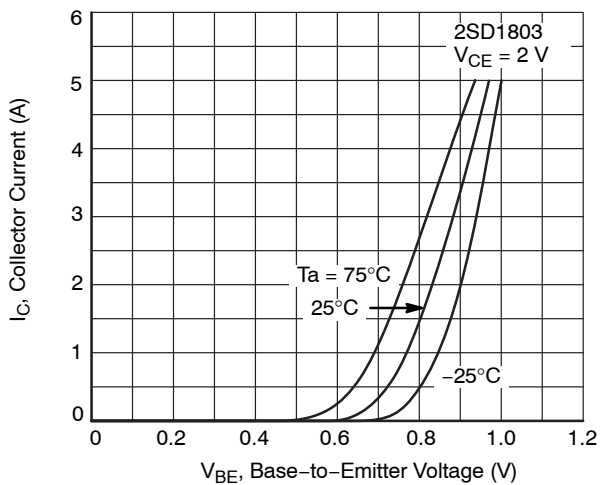

Figure 6. $I_C - V_{BE}$

2SB1203/2SD1803

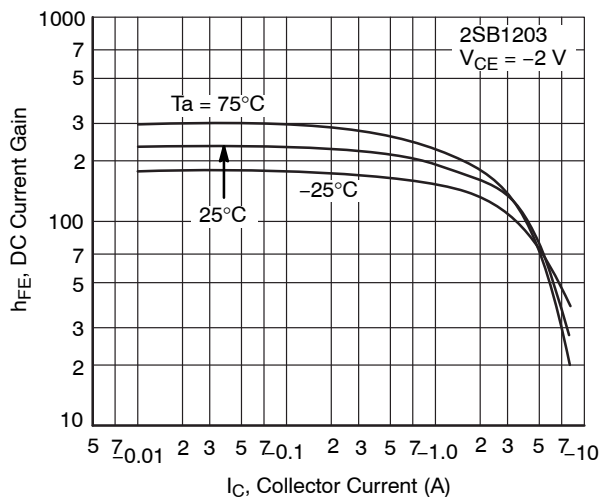

Figure 7. h_{FE} – I_C

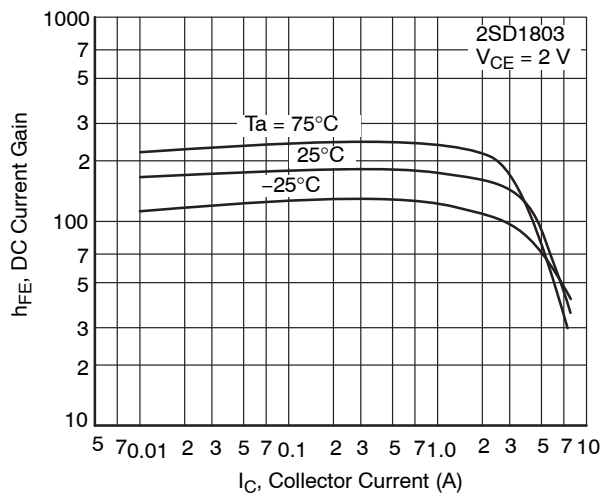

Figure 8. h_{FE} – I_C

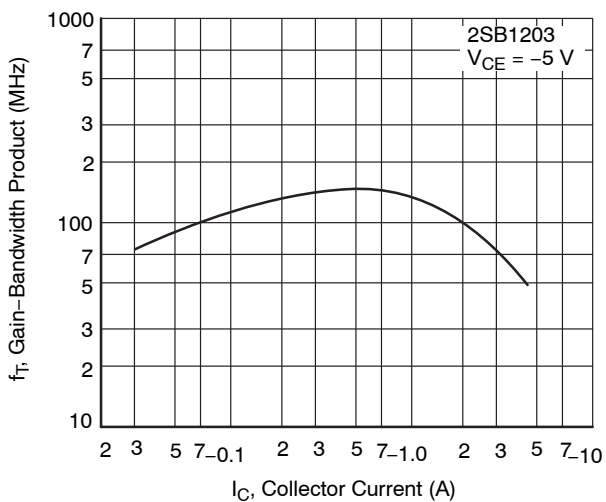

Figure 9. f_T – I_C

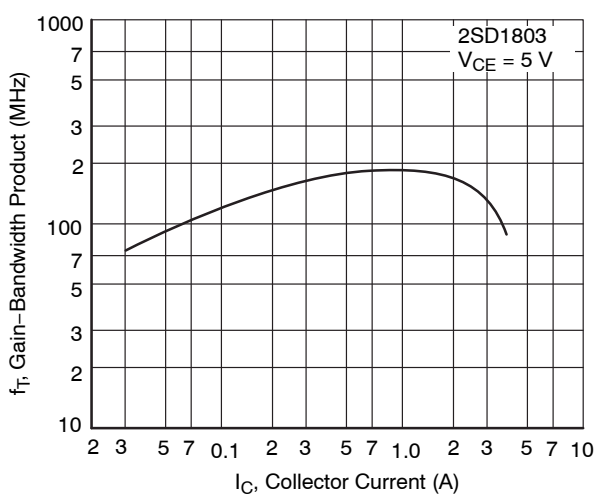

Figure 10. f_T – I_C

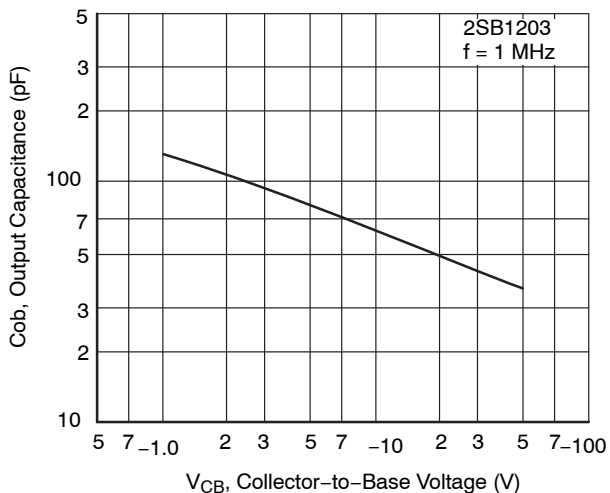

Figure 11. C_{ob} – V_{CB}

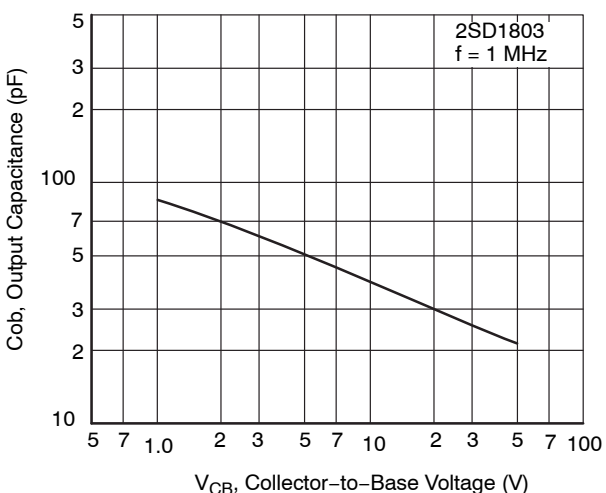

Figure 12. C_{ob} – V_{CB}

2SB1203/2SD1803

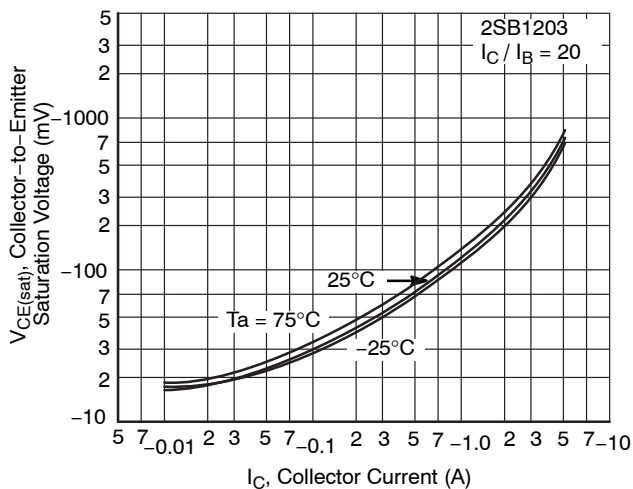

Figure 13. $V_{CE(sat)} - I_C$

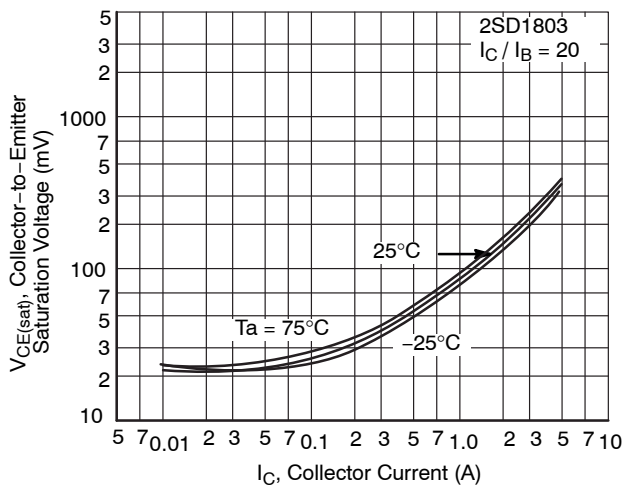

Figure 14. $V_{CE(sat)} - I_C$

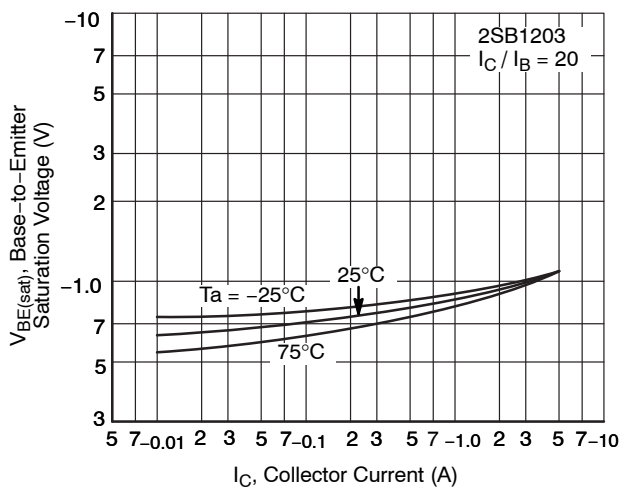

Figure 15. $V_{BE(sat)} - I_C$

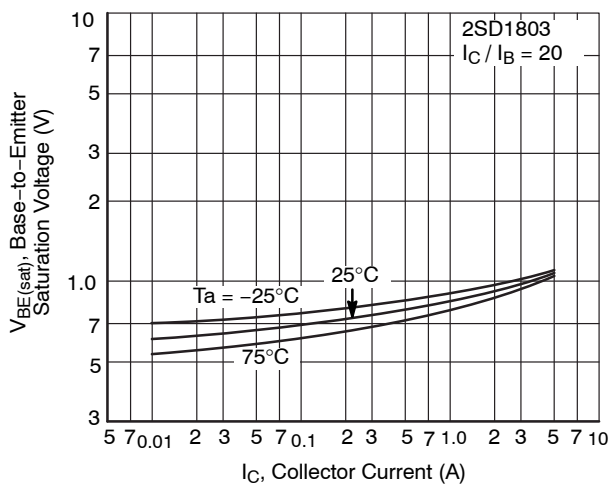

Figure 16. $V_{BE(sat)} - I_C$

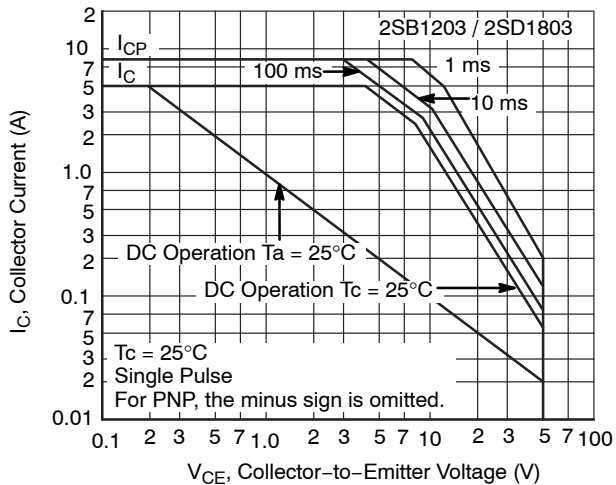

Figure 17. ASO

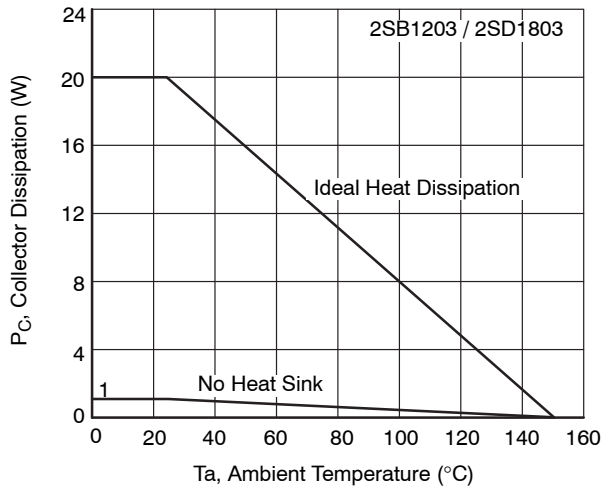

Figure 18. $P_C - T_a$

2SB1203/2SD1803

ORDERING INFORMATION

Device	Package	Shipping	memo
2SB1203S-E	TP	500pcs./bag	Pb Free
2SB1203S-H	TP	500pcs./bag	Pb Free and Halogen Free
2SB1203T-H	TP	500pcs./bag	Pb Free and Halogen Free
2SD1803S-E	TP	500pcs./bag	Pb Free
2SD1803S-H	TP	500pcs./bag	Pb Free and Halogen Free
2SD1803T-E	TP	500pcs./bag	Pb Free
2SD1803T-H	TP	500pcs./bag	Pb Free and Halogen Free
2SB1203S-TL-E	TP-FA	700pcs./bag	Pb Free
2SB1203S-TL-H	TP-FA	700pcs./bag	Pb Free and Halogen Free
2SB1203T-TL-E	TP-FA	700pcs./bag	Pb Free
2SB1203T-TL-H	TP-FA	700pcs./bag	Pb Free and Halogen Free
2SD1803S-TL-E	TP-FA	700pcs./bag	Pb Free
2SD1803S-TL-H	TP-FA	700pcs./bag	Pb Free and Halogen Free
2SD1803T-TL-E	TP-FA	700pcs./bag	Pb Free
2SD1803T-TL-H	TP-FA	700pcs./bag	Pb Free and Halogen Free

MECHANICAL CASE OUTLINE
PACKAGE DIMENSIONS

DPAK / TP-FA
CASE 369AH
ISSUE O

DATE 30 JAN 2012

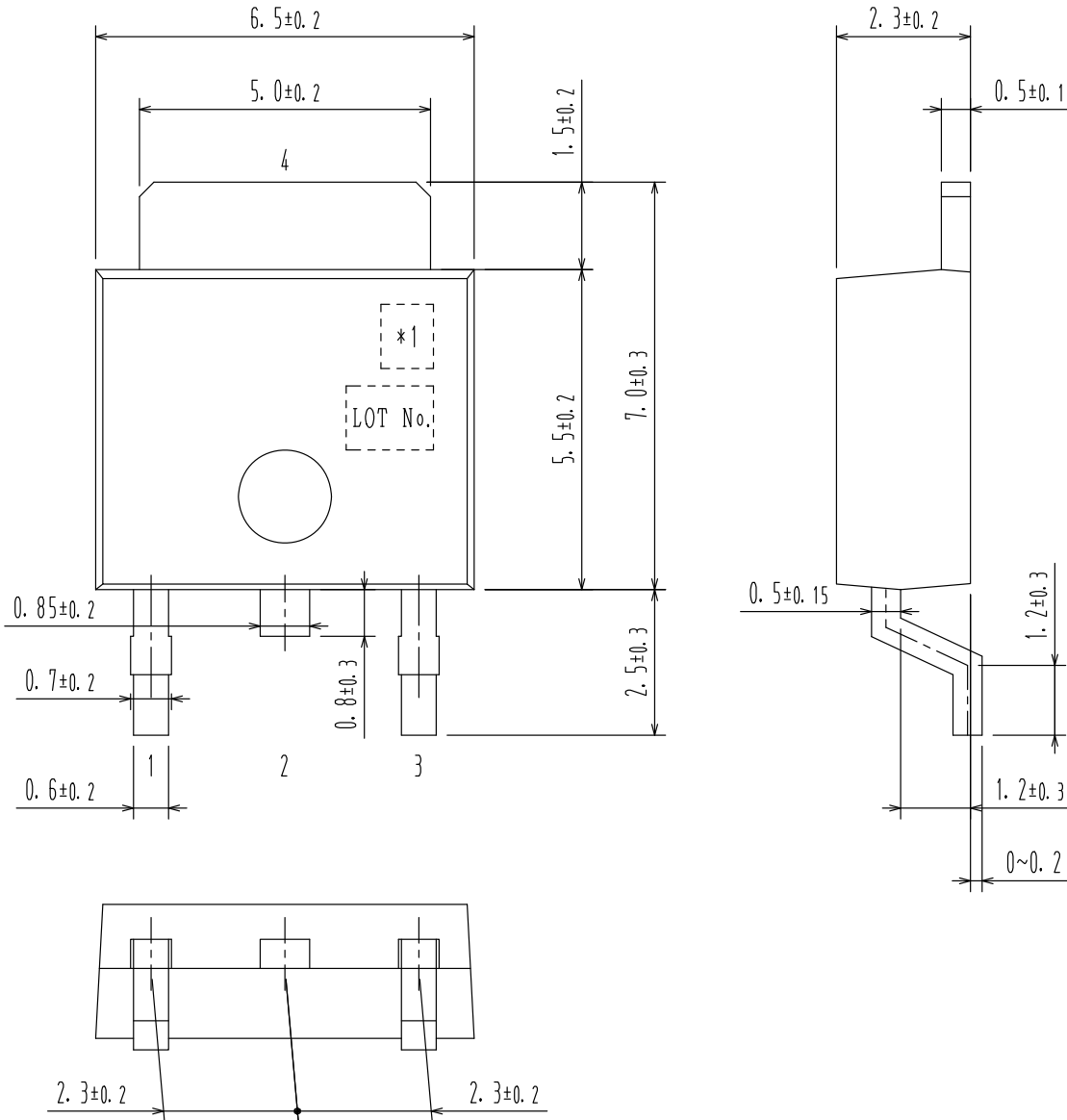

Pin 2 is idle pin with electrical designation only carried.

- 1:
- 2:
- 3:
- *1: Lot indication 4:

DOCUMENT NUMBER:	98AON66236E	Electronic versions are uncontrolled except when accessed directly from the Document Repository. Printed versions are uncontrolled except when stamped "CONTROLLED COPY" in red.
DESCRIPTION:	DPAK / TP-FA	PAGE 1 OF 1

ON Semiconductor and  are trademarks of Semiconductor Components Industries, LLC dba ON Semiconductor or its subsidiaries in the United States and/or other countries. ON Semiconductor reserves the right to make changes without further notice to any products herein. ON Semiconductor makes no warranty, representation or guarantee regarding the suitability of its products for any particular purpose, nor does ON Semiconductor assume any liability arising out of the application or use of any product or circuit, and specifically disclaims any and all liability, including without limitation special, consequential or incidental damages. ON Semiconductor does not convey any license under its patent rights nor the rights of others.

MECHANICAL CASE OUTLINE

PACKAGE DIMENSIONS

ON Semiconductor®



IPAK / TP
CASE 369AJ
ISSUE O

DATE 30 JAN 2012

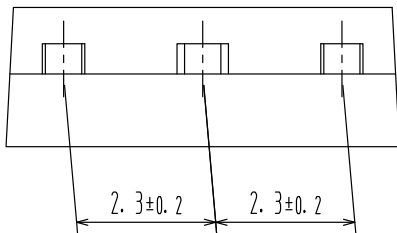
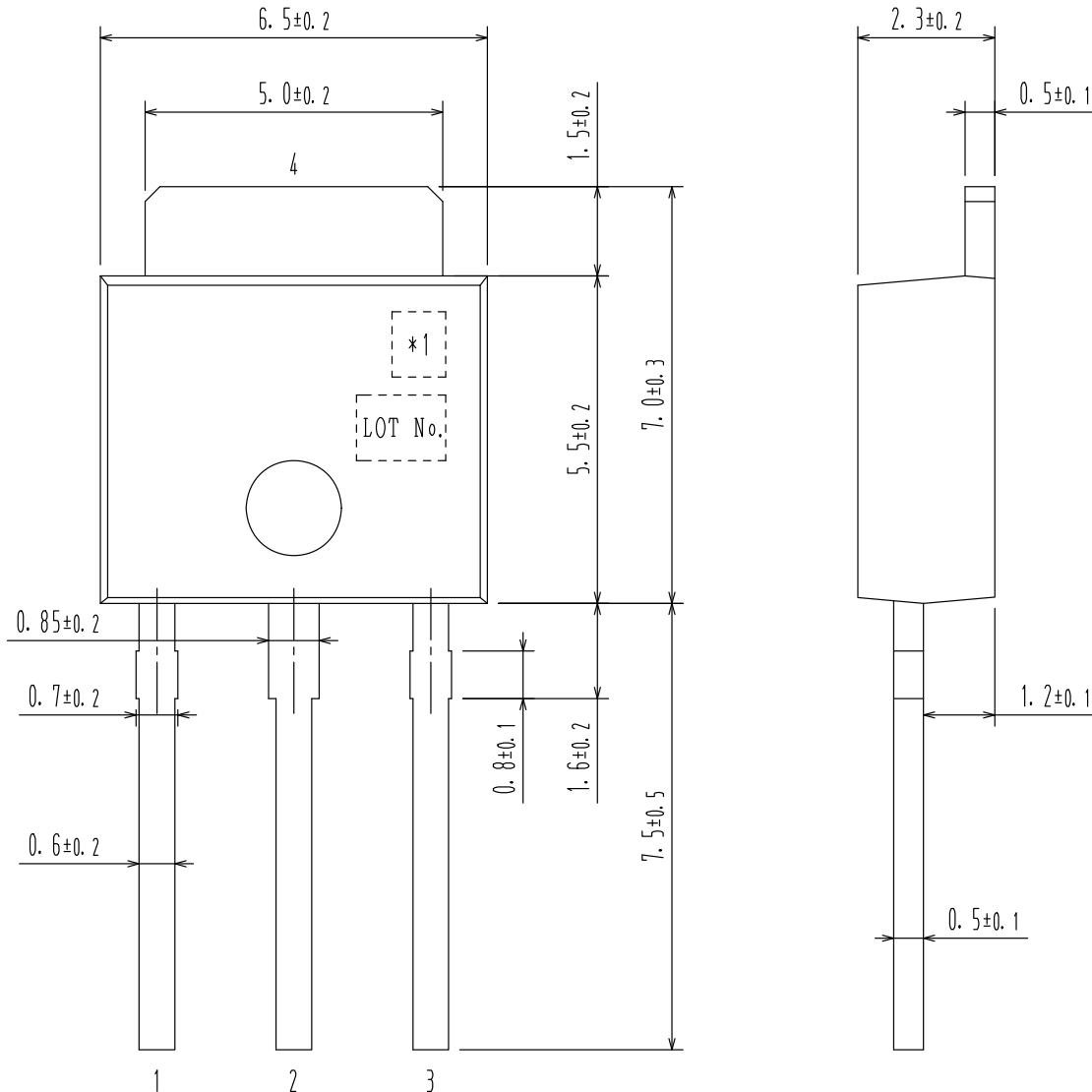

- 1:
 - 2:
 - 3:
 - 4:
- *1: Lot indication

DOCUMENT NUMBER:	98AON66237E	Electronic versions are uncontrolled except when accessed directly from the Document Repository. Printed versions are uncontrolled except when stamped "CONTROLLED COPY" in red.
DESCRIPTION:	IPAK / TP	PAGE 1 OF 1

ON Semiconductor and are trademarks of Semiconductor Components Industries, LLC dba ON Semiconductor or its subsidiaries in the United States and/or other countries. ON Semiconductor reserves the right to make changes without further notice to any products herein. ON Semiconductor makes no warranty, representation or guarantee regarding the suitability of its products for any particular purpose, nor does ON Semiconductor assume any liability arising out of the application or use of any product or circuit, and specifically disclaims any and all liability, including without limitation special, consequential or incidental damages. ON Semiconductor does not convey any license under its patent rights nor the rights of others.

onsemi, **Onsemi**, and other names, marks, and brands are registered and/or common law trademarks of Semiconductor Components Industries, LLC dba "**onsemi**" or its affiliates and/or subsidiaries in the United States and/or other countries. **onsemi** owns the rights to a number of patents, trademarks, copyrights, trade secrets, and other intellectual property. A listing of **onsemi**'s product/patent coverage may be accessed at www.onsemi.com/site/pdf/Patent-Marking.pdf. **onsemi** reserves the right to make changes at any time to any products or information herein, without notice. The information herein is provided "as-is" and **onsemi** makes no warranty, representation or guarantee regarding the accuracy of the information, product features, availability, functionality, or suitability of its products for any particular purpose, nor does **onsemi** assume any liability arising out of the application or use of any product or circuit, and specifically disclaims any and all liability, including without limitation special, consequential or incidental damages. Buyer is responsible for its products and applications using **onsemi** products, including compliance with all laws, regulations and safety requirements or standards, regardless of any support or applications information provided by **onsemi**. "Typical" parameters which may be provided in **onsemi** data sheets and/or specifications can and do vary in different applications and actual performance may vary over time. All operating parameters, including "Typicals" must be validated for each customer application by customer's technical experts. **onsemi** does not convey any license under any of its intellectual property rights nor the rights of others. **onsemi** products are not designed, intended, or authorized for use as a critical component in life support systems or any FDA Class 3 medical devices or medical devices with a same or similar classification in a foreign jurisdiction or any devices intended for implantation in the human body. Should Buyer purchase or use **onsemi** products for any such unintended or unauthorized application, Buyer shall indemnify and hold **onsemi** and its officers, employees, subsidiaries, affiliates, and distributors harmless against all claims, costs, damages, and expenses, and reasonable attorney fees arising out of, directly or indirectly, any claim of personal injury or death associated with such unintended or unauthorized use, even if such claim alleges that **onsemi** was negligent regarding the design or manufacture of the part. **onsemi** is an Equal Opportunity/Affirmative Action Employer. This literature is subject to all applicable copyright laws and is not for resale in any manner.

PUBLICATION ORDERING INFORMATION

LITERATURE FULFILLMENT:

Email Requests to: orderlit@onsemi.com

onsemi Website: www.onsemi.com

TECHNICAL SUPPORT

North American Technical Support:

Voice Mail: 1 800-282-9855 Toll Free USA/Canada

Phone: 011 421 33 790 2910

Europe, Middle East and Africa Technical Support:

Phone: 00421 33 790 2910

For additional information, please contact your local Sales Representative

