

6-Pin DIP High dv/dt Random Phase Triac Drivers

FOD420, FOD4208, FOD4216, FOD4218

Description

The FOD420, FOD4208, FOD4216 and FOD4218 devices consist of an infrared emitting diode coupled to a hybrid random phase triac formed with two inverse parallel SCRs which form the triac function capable of driving discrete triacs. The FOD4216 and FOD4218 utilize a high efficiency infrared emitting diode which offers an improved trigger sensitivity. These devices are housed in a standard 6-pin dual in-line (DIP) package.

Features

- 300 mA_{peak} On-State Current
- High Blocking Voltage
 - ◆ 600 V (FOD420, FOD4216)
 - ◆ 800 V (FOD4208, FOD4218)
- High Trigger Sensitivity
 - ◆ 1.3 mA (FOD4216, FOD4218)
 - ◆ 2 mA (FOD420, FOD4208)
- High Static dv/dt (10,000 V/μs)
- Safety and Regulatory Approvals:
 - ◆ UL1577, 5,000 VAC_{RMS} for 1 Minute
 - ◆ DIN-EN/IEC60747-5-5
- These Devices are Pb-Free and are RoHS Compliant

Applications

- Solid-State Relays
- Industrial Controls
- Lighting Controls
- Static Power Switches
- AC Motor Starters



ON Semiconductor®

www.onsemi.com



PDIP6 GW
CASE 709AG

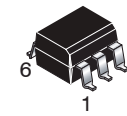

PDIP6 7.3x6.5, 2.54P
CASE 646CE

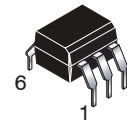

PDIP6 7.3x6.5, 2.54P
CASE 646CF

MARKING DIAGRAM



- ON = ON Semiconductor Logo
- FOD420 = Device Number
- V = VDE mark. DIN EN/IEC60747-5-5 Option (only appears on component ordered with this option)
- X = One-Digit Year Code
- YY = Digit Work Week
- D = Assembly Package Code

FUNCTIONAL SCHEMATIC



ORDERING INFORMATION

See detailed ordering and shipping information on page 8 of this data sheet.

SAFETY AND INSULATION RATINGS

| Parameter | | Characteristics |
|---|------------------------|-----------------|
| Installation Classifications per DIN VDE 0110/1.89 Table 1, For Rated Mains Voltage | < 150 V _{RMS} | I-IV |
| | < 300 V _{RMS} | I-IV |
| Climatic Classification | | 55/100/21 |
| Pollution Degree (DIN VDE 0110/1.89) | | 2 |
| Comparative Tracking Index | | 175 |

| Symbol | Parameter | Value | Unit |
|-----------------------|--|------------------|-------------------|
| V _{PR} | Input-to-Output Test Voltage, Method A, V _{IORM} × 1.6 = V _{PR} , Type and Sample Test with t _m = 10 s, Partial Discharge < 5 pC | 1360 | V _{peak} |
| | Input-to-Output Test Voltage, Method B, V _{IORM} × 1.875 = V _{PR} , 100% Production Test with t _m = 1 s, Partial Discharge < 5 pC | 1594 | V _{peak} |
| V _{IORM} | Maximum Working Insulation Voltage | 850 | V _{peak} |
| V _{IOTM} | Highest Allowable Over-Voltage | 6000 | V _{peak} |
| | External Creepage | ≥7 | mm |
| | External Clearance | ≥7 | mm |
| DTI | Distance Through Insulation (Insulation Thickness) | ≥0.4 | mm |
| T _S | Case Temperature (Note 1) | 175 | °C |
| I _{S,INPUT} | Input Current (Note 1) | 400 | mA |
| P _{S,OUTPUT} | Output Power (Note 1) | 700 | mW |
| R _{IO} | Insulation Resistance at T _S , V _{IO} = 500 V (Note 1) | >10 ⁹ | Ω |

As per DIN EN/IEC 60747-5-5, this optocoupler is suitable for “safe electrical insulation” only within the safety limit data. Compliance with the safety ratings shall be ensured by means of protective circuits.

1. Safety limit values – maximum values allowed in the event of a failure.

FOD420, FOD4208, FOD4216, FOD4218

ABSOLUTE MAXIMUM RATINGS (T_A = 25°C, unless otherwise specified)

| Symbol | Parameter | Device | Value | Unit |
|-----------------------|---------------------------------------|--------|----------------|-------|
| T _{STG} | Storage Temperature | All | -55 to +150 | °C |
| T _{OPR} | Operating Temperature | All | -55 to +100 | °C |
| T _J | Junction Temperature | All | -55 to +125 | °C |
| T _{SOL} | Lead Solder Temperature | All | 260 for 10 sec | °C |
| P _{D(TOTAL)} | Total Device Power Dissipation @ 25°C | All | 500 | mW |
| | Derate Above 25°C | All | 6.6 | mW/°C |

EMITTER

| | | | | |
|-------------------------|--------------------------------------|-----|------|-------|
| I _F | Continuous Forward Current | All | 30 | mA |
| V _R | Reverse Voltage | All | 6 | V |
| P _{D(EMITTER)} | Total Power Dissipation 25°C Ambient | All | 50 | mW |
| | Derate Above 25°C | All | 0.71 | mW/°C |

DETECTOR

| | | | | |
|--------------------------|--|------------------|-----|--------------------|
| V _{DRM} | Off-State Output Terminal Voltage | FOD420, FOD4216 | 600 | V |
| | | FOD4208, FOD4218 | 800 | |
| I _{TSM} | Peak Non-Repetitive Surge Current (single cycle 60 Hz sine wave) | All | 3 | A _{peak} |
| I _{TM} | Peak On-State Current | All | 300 | mA _{peak} |
| P _{D(DETECTOR)} | Total Power Dissipation @ 25°C Ambient | All | 450 | mW |
| P _{D(DETECTOR)} | Derate Above 25°C | All | 5.9 | mW/°C |

Stresses exceeding those listed in the Maximum Ratings table may damage the device. If any of these limits are exceeded, device functionality should not be assumed, damage may occur and reliability may be affected.

FOD420, FOD4208, FOD4216, FOD4218

ELECTRICAL CHARACTERISTICS (T_A = 25°C unless otherwise specified)

| Symbol | Parameter | Test Condition | Device | Min | Typ | Max | Unit |
|--------|-----------|----------------|--------|-----|-----|-----|------|
|--------|-----------|----------------|--------|-----|-----|-----|------|

INDIVIDUAL COMPONENT CHARACTERISTICS

| Emitter | | | | | | | | |
|---------------------|--|---|-----------------------------------|------------------|--------|------|-----|------|
| V _F | Input Forward Voltage | I _F = 20 mA | All | – | 1.28 | 1.50 | V | |
| I _R | Reverse Leakage Current | V _R = 6 V | All | – | 0.01 | 10 | μA | |
| Detector | | | | | | | | |
| I _{D(RMS)} | Peak Blocking Current, Either Direction | I _F = 0, T _A = 100°C (Note 2) | V _D = 600 V | FOD420, FOD4216 | – | 3 | 100 | μA |
| | | | V _D = 800 V | FOD4208, FOD4218 | | | | |
| I _{R(RMS)} | Reverse Current | T _A = 100°C | V _D = 600 V | FOD420, FOD4216 | – | 3 | 100 | μA |
| | | | V _D = 800 V | FOD4208, FOD4218 | | | | |
| dv/dt | Critical Rate of Rise of Off-State Voltage | I _F = 0 A (Note 3) | V _D = V _{DRM} | All | 10,000 | – | – | V/μs |

TRANSFER CHARACTERISTICS

| | | | | | | | | |
|------------------------|---|---|---|--------------------------|--------|------|-----|------|
| I _{FT} | LED Trigger Current | Main Terminal Voltage = 5 V (Note 4) | | FOD420, FOD4208 | – | 0.75 | 2.0 | mA |
| | | | | FOD4216, FOD4218 | | | | |
| V _{TM} | Peak On-State Voltage, Either Direction | I _{TM} = 300 mA peak, I _F = Rated I _{FT} | | All | – | 2.2 | 3 | V |
| I _H | Holding Current, Either Direction | V _T = 3 V | | All | – | 200 | 500 | μA |
| I _L | Latching Current | V _T = 2.2 V | | All | – | 5 | – | mA |
| t _{ON} | Turn-On Time | PF = 1.0, I _T = 300 mA | V _{RM} = V _{DM} = 424 VAC | FOD420, FOD4216, FOD4218 | – | 60 | – | μs |
| | | | V _{RM} = V _{DM} = 565 VAC | FOD4208 | | | | |
| t _{OFF} | Turn-Off Time | | V _{RM} = V _{DM} = 424 VAC | FOD420, FOD4216, FOD4218 | – | 52 | – | μs |
| | | | V _{RM} = V _{DM} = 565 VAC | FOD4208 | | | | |
| dv/dt _C | Critical Rate of Rise of Voltage at Current Commutation | V _D = 230 V _{RMS} , I _D = 300 mA _{PK} | | All | – | 10 | – | V/μs |
| di/dt _C | Critical Rate of Rise of On-State Current Commutation | V _D = 230 V _{RMS} , I _D = 300 mA _{PK} | | All | – | 9 | – | A/ms |
| dv(I _O)/dt | Critical Rate of Rise of Coupled Input / Output Voltage | I _T = 0 A, V _{RM} = V _{DM} = 424 VAC | | All | 10,000 | – | – | V/μs |

ISOLATION CHARACTERISTICS

| | | | | | | | |
|------------------|--------------------------------|----------------------------------|-----|-------|---|---|--------------------|
| V _{ISO} | Steady State Isolation Voltage | f = 60 Hz, t = 1 Minute (Note 5) | All | 5,000 | – | – | VAC _{RMS} |
|------------------|--------------------------------|----------------------------------|-----|-------|---|---|--------------------|

Product parametric performance is indicated in the Electrical Characteristics for the listed test conditions, unless otherwise noted. Product performance may not be indicated by the Electrical Characteristics if operated under different conditions.

- Test voltage must be applied within dv/dt rating.
- This is static dv/dt. Commutating dv/dt is a function of the load-driving thyristor(s) only.
- All devices are guaranteed to trigger at an I_F value less than or equal to max I_{FT}. Therefore, recommended operating I_F lies between max I_{FT} (2 mA for FOD420 and FOD4208 and 1.3 mA for FOD4216 and FOD4218) and the absolute max I_F (30 mA).
- Isolation voltage, V_{ISO}, is an internal device dielectric breakdown rating. For this test, pins 1, 2 and 3 are common, and pins 4, 5 and 6 are common. 5,000 VAC_{RMS} for 1 minute duration is equivalent to 6,000 VAC_{RMS} for 1 second duration.

FOD420, FOD4208, FOD4216, FOD4218

TYPICAL APPLICATION

Figure 1 shows a typical circuit for when hot line switching is required. In this circuit the “hot” side of the line is switched and the load connected to the cold or neutral side. The load may be connected to either the neutral or hot line.

R_{in} is calculated so that IF is equal to the rated IFT of the

part, 2 mA for FOD420 and FOD4208, 1.3 mA for FOD4216 and FOD4218. The 39 Ω resistor and 0.01 μ F capacitor are for snubbing of the triac and may or may not be necessary depending upon the particular triac and load use.



*For highly inductive loads (power factor < 0.5), change this value to 360 Ω .

Figure 1. Hot-Line Switching Application Circuit



Figure 2. Inverse-Parallel SCR Driver Circuit

Suggested method of firing two, back-to-back SCR's with On Semiconductor triac driver. Diodes can be 1N4001; resistors, R1 and R2, are optional 330 Ω .

NOTE: This optoisolator should not be used to drive a load directly. It is intended to be a discrete triac driver device only.

TYPICAL CHARACTERISTICS

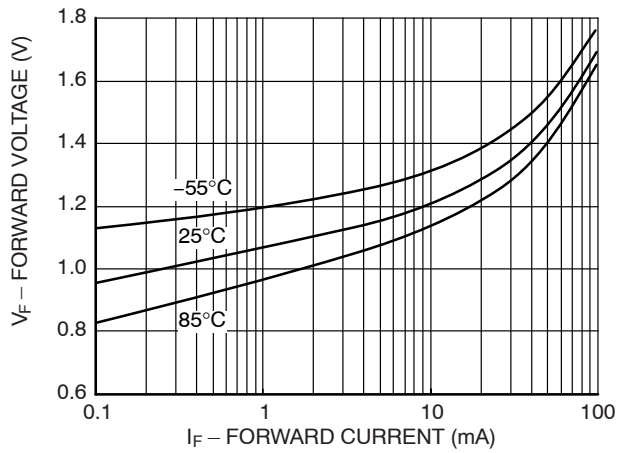

Figure 3. Forward Voltage (V_F) vs. Forward Current (I_F)

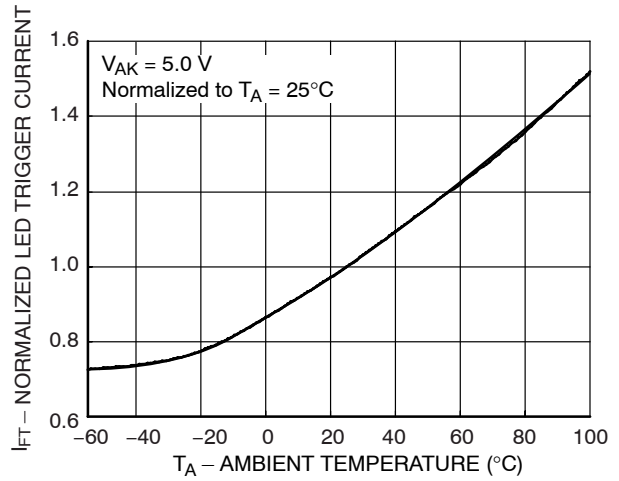

Figure 4. Normalized LED Trigger Current (I_{FT}) vs. Ambient Temperature (T_A)

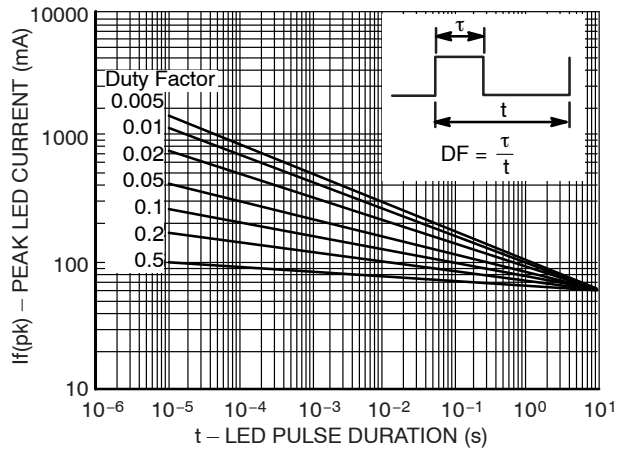

Figure 5. Peak LED Current vs. Duty Factor, Tau

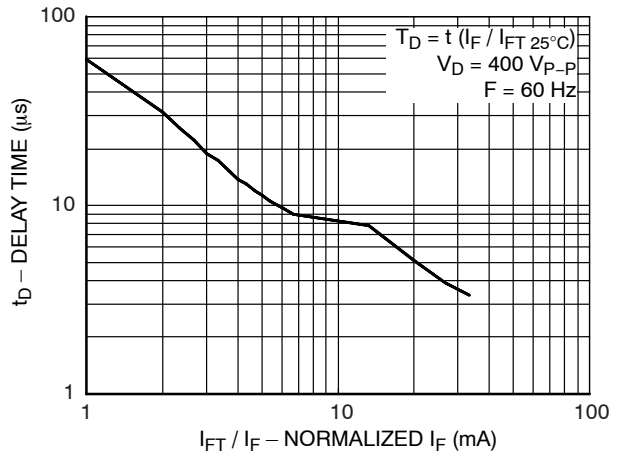

Figure 6. Trigger Delay Time

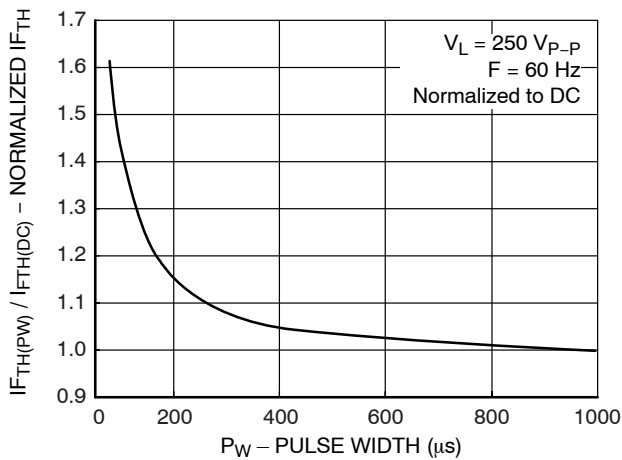

Figure 7. Pulse Trigger Current

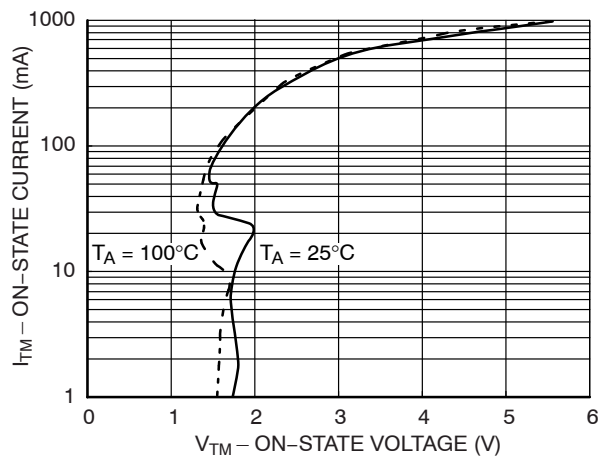

Figure 8. On-State Voltage (V_{TM}) vs. On-State Current (I_{TM})

TYPICAL CHARACTERISTICS (continued)



Figure 9. Normalized Holding Current (I_H) vs. Ambient Temperature (T_A)

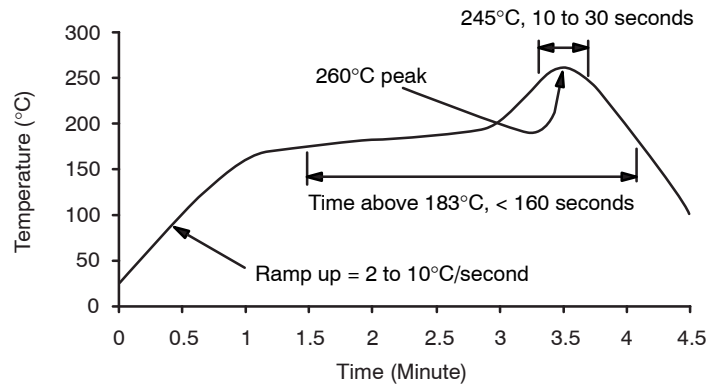

Figure 10. Normalized Off-State Current (I_{DRM}) vs. Ambient Temperature (T_A)



Figure 11. Current Reduction

REFLOW PROFILE



- Peak reflow temperature: 262°C (package surface temperature)
- Time of temperature higher than 183°C for 160 seconds or less
- One time soldering reflow is recommended

Figure 12. Reflow Profile

ORDERING INFORMATION

| Part Number | Package | Shipping† |
|-------------|--|--------------------|
| FOD420 | DIP 6-Pin | 50 Units / Tube |
| FOD420S | SMT 6-Pin (Lead Bend) | 50 Units / Tube |
| FOD420SD | SMT 6-Pin (Lead Bend) | 1000 / Tape & Reel |
| FOD420V | DIP 6-Pin, DIN EN/IEC60747-5-5 Option | 50 Units / Tube |
| FOD420SV | SMT 6-Pin (Lead Bend), DIN EN/IEC60747-5-5 Option | 50 Units / Tube |
| FOD420SDV | SMT 6-Pin (Lead Bend), DIN EN/IEC60747-5-5 Option | 1000 / Tape & Reel |
| FOD420TV | DIP 6-Pin, 0.4" Lead Spacing, DIN EN/IEC60747-5-5 Option | 50 Units / Tube |

†For information on tape and reel specifications, including part orientation and tape sizes, please refer to our Tape and Reel Packaging Specifications Brochure, BRD8011/D.

6. The product orderable part number system listed in this table also applies to the FOD4208, FOD4216, and FOD4218 product families.

MECHANICAL CASE OUTLINE

PACKAGE DIMENSIONS

ON Semiconductor®



PDIP6 7.3x6.5, 2.54P
CASE 646CE
ISSUE O

DATE 31 JUL 2016

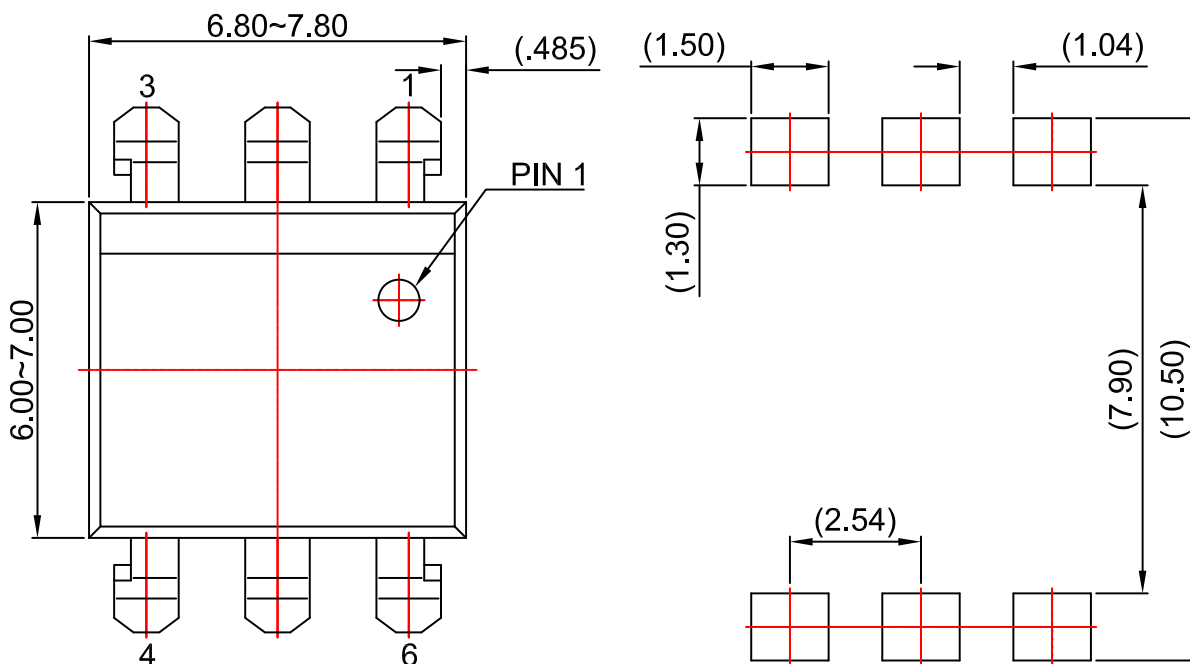

LAND PATTERN RECOMMENDATION

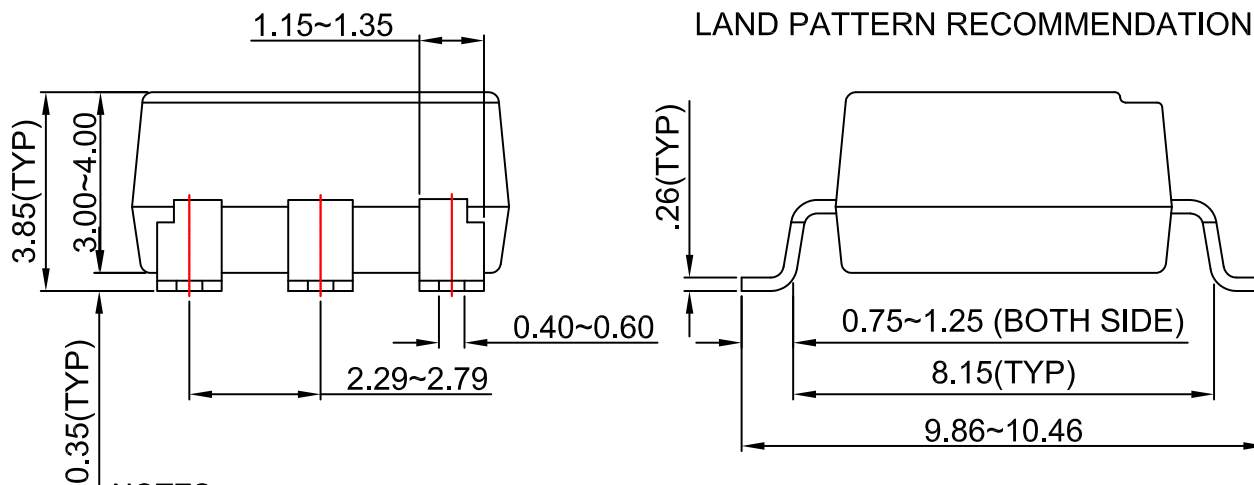

NOTES:

- A) NO STANDARD APPLIES TO THIS PACKAGE.
- B) ALL DIMENSIONS ARE IN MILLIMETERS.
- C) DIMENSIONS ARE EXCLUSIVE OF BURRS, MOLD FLASH, AND TIE BAR EXTRUSION

| | | |
|-------------------------|-----------------------------|--|
| DOCUMENT NUMBER: | 98AON13456G | Electronic versions are uncontrolled except when accessed directly from the Document Repository. Printed versions are uncontrolled except when stamped "CONTROLLED COPY" in red. |
| DESCRIPTION: | PDIP6 7.3X6.5, 2.54P | PAGE 1 OF 1 |

ON Semiconductor and are trademarks of Semiconductor Components Industries, LLC dba ON Semiconductor or its subsidiaries in the United States and/or other countries. ON Semiconductor reserves the right to make changes without further notice to any products herein. ON Semiconductor makes no warranty, representation or guarantee regarding the suitability of its products for any particular purpose, nor does ON Semiconductor assume any liability arising out of the application or use of any product or circuit, and specifically disclaims any and all liability, including without limitation special, consequential or incidental damages. ON Semiconductor does not convey any license under its patent rights nor the rights of others.

MECHANICAL CASE OUTLINE

PACKAGE DIMENSIONS

ON Semiconductor®



PDIP6 7.3x6.5, 2.54P
CASE 646CF
ISSUE O

DATE 31 JUL 2016



NOTES:

- A) NO STANDARD APPLIES TO THIS PACKAGE.
- B) ALL DIMENSIONS ARE IN MILLIMETERS.
- C) DIMENSIONS ARE EXCLUSIVE OF BURRS, MOLD FLASH, AND TIE BAR EXTRUSION

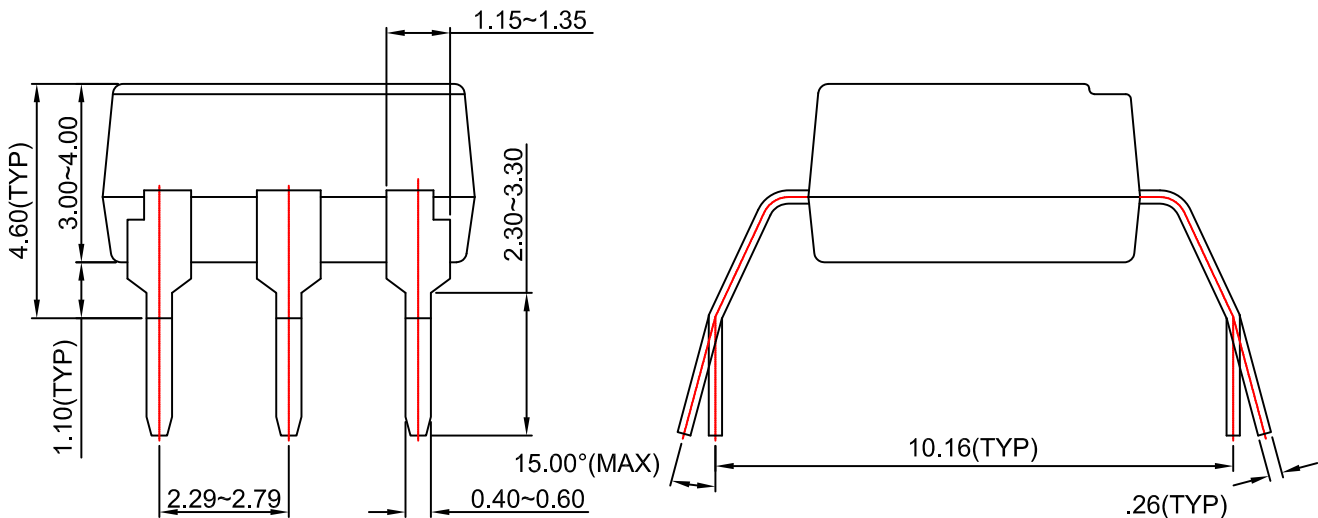

| | | |
|-------------------------|-----------------------------|--|
| DOCUMENT NUMBER: | 98AON13457G | Electronic versions are uncontrolled except when accessed directly from the Document Repository. Printed versions are uncontrolled except when stamped "CONTROLLED COPY" in red. |
| DESCRIPTION: | PDIP6 7.3X6.5, 2.54P | PAGE 1 OF 1 |

ON Semiconductor and are trademarks of Semiconductor Components Industries, LLC dba ON Semiconductor or its subsidiaries in the United States and/or other countries. ON Semiconductor reserves the right to make changes without further notice to any products herein. ON Semiconductor makes no warranty, representation or guarantee regarding the suitability of its products for any particular purpose, nor does ON Semiconductor assume any liability arising out of the application or use of any product or circuit, and specifically disclaims any and all liability, including without limitation special, consequential or incidental damages. ON Semiconductor does not convey any license under its patent rights nor the rights of others.

MECHANICAL CASE OUTLINE
PACKAGE DIMENSIONS



PDIP6 GW
CASE 709AG
ISSUE A

DATE 31 JUL 2016

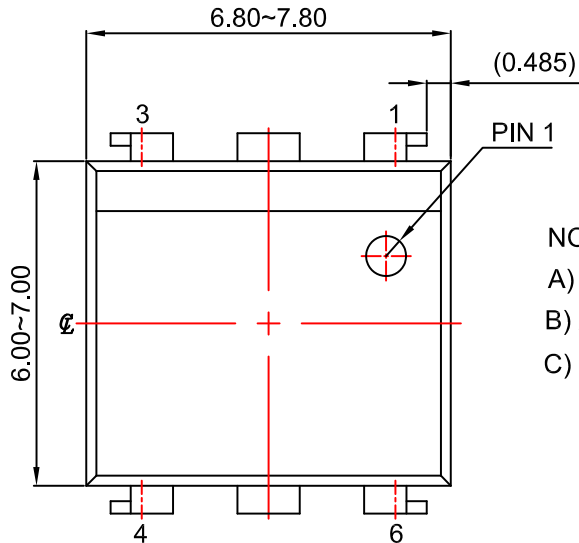

- NOTES:
- A) NO STANDARD APPLIES TO THIS PACKAGE.
 - B) ALL DIMENSIONS ARE IN MILLIMETERS.
 - C) DIMENSIONS ARE EXCLUSIVE OF BURRS, MOLD FLASH, AND TIE BAR EXTRUSION

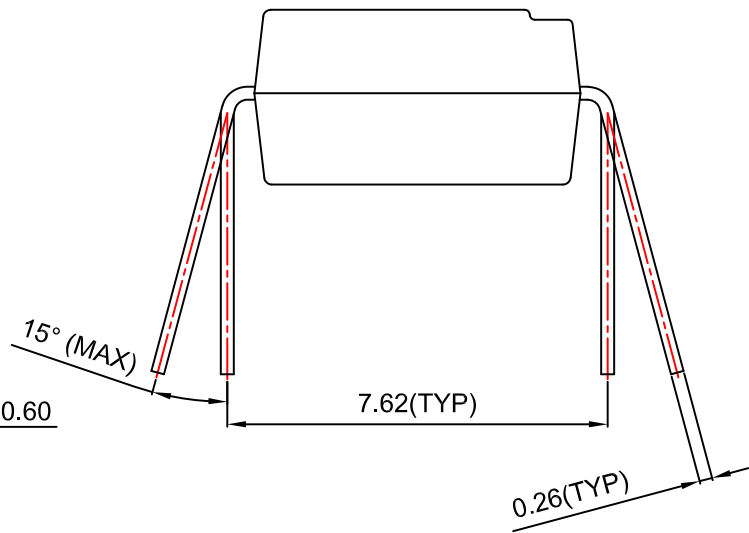
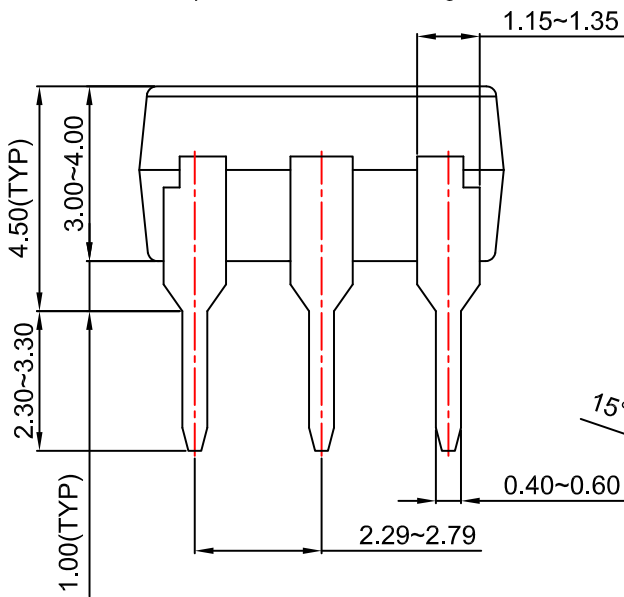

| | | |
|-------------------------|--------------------|--|
| DOCUMENT NUMBER: | 98AON13455G | Electronic versions are uncontrolled except when accessed directly from the Document Repository. Printed versions are uncontrolled except when stamped "CONTROLLED COPY" in red. |
| DESCRIPTION: | PDIP6 GW | PAGE 1 OF 1 |

ON Semiconductor and are trademarks of Semiconductor Components Industries, LLC dba ON Semiconductor or its subsidiaries in the United States and/or other countries. ON Semiconductor reserves the right to make changes without further notice to any products herein. ON Semiconductor makes no warranty, representation or guarantee regarding the suitability of its products for any particular purpose, nor does ON Semiconductor assume any liability arising out of the application or use of any product or circuit, and specifically disclaims any and all liability, including without limitation special, consequential or incidental damages. ON Semiconductor does not convey any license under its patent rights nor the rights of others.

onsemi, **Onsemi**, and other names, marks, and brands are registered and/or common law trademarks of Semiconductor Components Industries, LLC dba "**onsemi**" or its affiliates and/or subsidiaries in the United States and/or other countries. **onsemi** owns the rights to a number of patents, trademarks, copyrights, trade secrets, and other intellectual property. A listing of **onsemi**'s product/patent coverage may be accessed at www.onsemi.com/site/pdf/Patent-Marking.pdf. **onsemi** reserves the right to make changes at any time to any products or information herein, without notice. The information herein is provided "as-is" and **onsemi** makes no warranty, representation or guarantee regarding the accuracy of the information, product features, availability, functionality, or suitability of its products for any particular purpose, nor does **onsemi** assume any liability arising out of the application or use of any product or circuit, and specifically disclaims any and all liability, including without limitation special, consequential or incidental damages. Buyer is responsible for its products and applications using **onsemi** products, including compliance with all laws, regulations and safety requirements or standards, regardless of any support or applications information provided by **onsemi**. "Typical" parameters which may be provided in **onsemi** data sheets and/or specifications can and do vary in different applications and actual performance may vary over time. All operating parameters, including "Typicals" must be validated for each customer application by customer's technical experts. **onsemi** does not convey any license under any of its intellectual property rights nor the rights of others. **onsemi** products are not designed, intended, or authorized for use as a critical component in life support systems or any FDA Class 3 medical devices or medical devices with a same or similar classification in a foreign jurisdiction or any devices intended for implantation in the human body. Should Buyer purchase or use **onsemi** products for any such unintended or unauthorized application, Buyer shall indemnify and hold **onsemi** and its officers, employees, subsidiaries, affiliates, and distributors harmless against all claims, costs, damages, and expenses, and reasonable attorney fees arising out of, directly or indirectly, any claim of personal injury or death associated with such unintended or unauthorized use, even if such claim alleges that **onsemi** was negligent regarding the design or manufacture of the part. **onsemi** is an Equal Opportunity/Affirmative Action Employer. This literature is subject to all applicable copyright laws and is not for resale in any manner.

PUBLICATION ORDERING INFORMATION

LITERATURE FULFILLMENT:

Email Requests to: orderlit@onsemi.com

onsemi Website: www.onsemi.com

TECHNICAL SUPPORT

North American Technical Support:

Voice Mail: 1 800-282-9855 Toll Free USA/Canada

Phone: 011 421 33 790 2910

Europe, Middle East and Africa Technical Support:

Phone: 00421 33 790 2910

For additional information, please contact your local Sales Representative

