

# MMBZxxxALT1G Series, SZMMBZxxxALT1G Series

## Zener Diodes, 24 and 40 Watt Peak Power

### SOT-23 Dual Common Anode Zeners

These dual monolithic silicon Zener diodes are designed for applications requiring transient overvoltage protection capability. They are intended for use in voltage and ESD sensitive equipment such as computers, printers, business machines, communication systems, medical equipment and other applications. Their dual junction common anode design protects two separate lines using only one package. These devices are ideal for situations where board space is at a premium.

#### Features

- SOT-23 Package Allows Either Two Separate Unidirectional Configurations or a Single Bidirectional Configuration
- Standard Zener Breakdown Voltage Range – 5.6 V to 47 V
- Peak Power – 24 or 40 W @ 1.0 ms (Unidirectional), per Figure 6 Waveform
- ESD Rating:
  - Class 3B (> 16 kV) per the Human Body Model
  - Class C (> 400 V) per the Machine Model
- ESD Rating of IEC61000-4-2 Level 4, ±30 kV Contact Discharge
- Maximum Clamping Voltage @ Peak Pulse Current
- Low Leakage < 5.0 µA
- Flammability Rating UL 94 V-0
- SZ Prefix for Automotive and Other Applications Requiring Unique Site and Control Change Requirements; AEC-Q101 Qualified and PPAP Capable
- These Devices are Pb-Free and are RoHS Compliant

#### Mechanical Characteristics

**CASE:** Void-free, transfer-molded, thermosetting plastic case

**FINISH:** Corrosion resistant finish, easily solderable

#### MAXIMUM CASE TEMPERATURE FOR SOLDERING PURPOSES:

260°C for 10 Seconds

Package designed for optimal automated board assembly

Small package size for high density applications

Available in 8 mm Tape and Reel

Use the Device Number to order the 7 inch/3,000 unit reel.

Replace the “T1” with “T3” in the Device Number to order the

13 inch/10,000 unit reel.



ON Semiconductor®

[www.onsemi.com](http://www.onsemi.com)

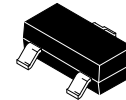

SOT-23  
CASE 318  
STYLE 12

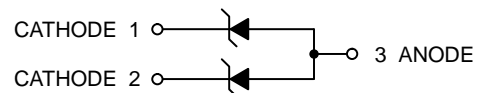

#### MARKING DIAGRAM

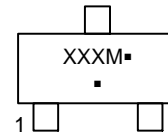

XXX = Specific Device Code

M = Date Code

▪ = Pb-Free Package

(Note: Microdot may be in either location)

#### ORDERING INFORMATION

See detailed ordering and shipping information on page 2 of this data sheet.

#### DEVICE MARKING INFORMATION

See specific marking information in the device marking column of the table on page 3 of this data sheet.

## MMBZxxxALT1G Series, SZMMBZxxxALT1G Series

### MAXIMUM RATINGS

| Rating   | Symbol                                 | Value        | Unit                       |
|--|--|--------------|----------------------------|
| Peak Power Dissipation @ 1.0 ms (Note 1)<br>@ $T_L \leq 25^\circ\text{C}$  | $P_{pk}$                               | 24<br>40     | W                          |
| Total Power Dissipation on FR-5 Board (Note 2)<br>@ $T_A = 25^\circ\text{C}$<br>Derate above $25^\circ\text{C}$        | $P_D$                                  | 225<br>1.8   | mW<br>mW/ $^\circ\text{C}$ |
|  | $R_{\theta JA}$                        | 556          | $^\circ\text{C/W}$         |
|  | Thermal Resistance Junction-to-Ambient |              |                            |
| Total Power Dissipation on Alumina Substrate (Note 3)<br>@ $T_A = 25^\circ\text{C}$<br>Derate above $25^\circ\text{C}$ | $P_D$                                  | 300<br>2.4   | mW<br>mW/ $^\circ\text{C}$ |
|  | $R_{\theta JA}$                        | 417          | $^\circ\text{C/W}$         |
|  | Thermal Resistance Junction-to-Ambient |              |                            |
| Junction and Storage Temperature Range   | $T_J, T_{stg}$                         | - 55 to +150 | $^\circ\text{C}$           |
| Lead Solder Temperature – Maximum (10 Second Duration)   | $T_L$                                  | 260          | $^\circ\text{C}$           |

Stresses exceeding those listed in the Maximum Ratings table may damage the device. If any of these limits are exceeded, device functionality should not be assumed, damage may occur and reliability may be affected.

1. Non-repetitive current pulse per Figure 6 and derate above  $T_A = 25^\circ\text{C}$  per Figure 7.
2. FR-5 = 1.0 x 0.75 x 0.62 in.
3. Alumina = 0.4 x 0.3 x 0.024 in, 99.5% alumina.

\*Other voltages may be available upon request.

### ORDERING INFORMATION

| Device          | Package             | Shipping <sup>†</sup> |
|-----------------|---------------------|-----------------------|
| MMBZ5V6ALT1G    | SOT-23<br>(Pb-Free) | 3,000 / Tape & Reel   |
| SZMMBZ5V6ALT1G* | SOT-23<br>(Pb-Free) | 3,000 / Tape & Reel   |
| MMBZ5V6ALT3G    | SOT-23<br>(Pb-Free) | 10,000 / Tape & Reel  |
| MMBZ6VxALT1G    | SOT-23<br>(Pb-Free) | 3,000 / Tape & Reel   |
| SZMMBZ6VxALT1G* | SOT-23<br>(Pb-Free) | 3,000 / Tape & Reel   |
| MMBZ6VxALT3G    | SOT-23<br>(Pb-Free) | 10,000 / Tape & Reel  |
| MMBZ9V1ALT1G    | SOT-23<br>(Pb-Free) | 3,000 / Tape & Reel   |
| MMBZ9V1ALT13G   | SOT-23<br>(Pb-Free) | 10,000 / Tape & Reel  |
| MMBZxxVALT1G    | SOT-23<br>(Pb-Free) | 3,000 / Tape & Reel   |
| SZMMBZxxVALT1G* | SOT-23<br>(Pb-Free) | 3,000 / Tape & Reel   |
| MMBZxxVALT3G    | SOT-23<br>(Pb-Free) | 10,000 / Tape & Reel  |
| SZMMBZxxVALT3G* | SOT-23<br>(Pb-Free) | 10,000 / Tape & Reel  |
| SZMMBZxxVALT1G* | SOT-23<br>(Pb-Free) | 3,000 / Tape & Reel   |

<sup>†</sup>For information on tape and reel specifications, including part orientation and tape sizes, please refer to our Tape and Reel Packaging Specifications Brochure, BRD8011/D.

\*SZ Prefix for Automotive and Other Applications Requiring Unique Site and Control Change Requirements; AEC-Q101 Qualified and PPAP Capable

# MMBZxxxALT1G Series, SZMMBZxxxALT1G Series

## ELECTRICAL CHARACTERISTICS

(T<sub>A</sub> = 25°C unless otherwise noted)

**UNIDIRECTIONAL** (Circuit tied to Pins 1 and 3 or 2 and 3)

| Symbol           | Parameter  |
|------------------|--|
| I <sub>PP</sub>  | Maximum Reverse Peak Pulse Current                 |
| V <sub>C</sub>   | Clamping Voltage @ I <sub>PP</sub>                 |
| V <sub>RWM</sub> | Working Peak Reverse Voltage                       |
| I <sub>R</sub>   | Maximum Reverse Leakage Current @ V <sub>RWM</sub> |
| V <sub>BR</sub>  | Breakdown Voltage @ I <sub>T</sub>                 |
| I <sub>T</sub>   | Test Current                                       |
| ΘV <sub>BR</sub> | Maximum Temperature Coefficient of V <sub>BR</sub> |
| I <sub>F</sub>   | Forward Current                                    |
| V <sub>F</sub>   | Forward Voltage @ I <sub>F</sub>                   |
| Z <sub>ZT</sub>  | Maximum Zener Impedance @ I <sub>ZT</sub>          |
| I <sub>ZK</sub>  | Reverse Current                                    |
| Z <sub>ZK</sub>  | Maximum Zener Impedance @ I <sub>ZK</sub>          |

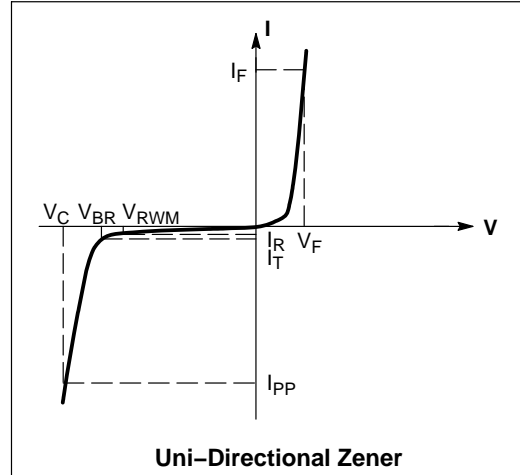

**ELECTRICAL CHARACTERISTICS** (T<sub>A</sub> = 25°C unless otherwise noted)

**UNIDIRECTIONAL** (Circuit tied to Pins 1 and 3 or Pins 2 and 3)

(V<sub>F</sub> = 0.9 V Max @ I<sub>F</sub> = 10 mA) (5% Tolerance)

**24 WATTS**

| Device*          | Device Marking | V <sub>RWM</sub><br>Volts | I <sub>R</sub> @<br>V <sub>RWM</sub><br>μA | Breakdown Voltage            |     |      |                        | Max Zener Impedance (Note 5)              |  |                     | V <sub>C</sub> @ I <sub>PP</sub> (Note 6) |      | ΘV <sub>BR</sub><br>mV/°C |
|------------------|----------------|---------------------------|--|------------------------------|-----|------|------------------------|---|--|---------------------|---|------|---------------------------|
|                  |                |                           |  | V <sub>BR</sub> (Note 4) (V) |     |      | @ I <sub>T</sub><br>mA | Z <sub>ZT</sub><br>@ I <sub>ZT</sub><br>Ω | Z <sub>ZK</sub> @ I <sub>ZK</sub><br>Ω | V <sub>C</sub><br>V | I <sub>PP</sub><br>A                      |      |                           |
|                  |                |                           |  | Min                          | Nom | Max  |                        |   |  |                     |   |      |                           |
| MMBZ5V6ALT1G/T3G | 5A6            | 3.0                       | 5.0  | 5.32                         | 5.6 | 5.88 | 20                     | 11  | 1600                                   | 0.25                | 8.0                                       | 3.0  | 1.26                      |
| MMBZ6V2ALT1G     | 6A2            | 3.0                       | 0.5  | 5.89                         | 6.2 | 6.51 | 1.0                    | -   | -                                      | -                   | 8.7                                       | 2.76 | 2.80                      |
| MMBZ6V8ALT1G     | 6A8            | 4.5                       | 0.5  | 6.46                         | 6.8 | 7.14 | 1.0                    | -   | -                                      | -                   | 9.6                                       | 2.5  | 3.4                       |
| MMBZ9V1ALT1G     | 9A1            | 6.0                       | 0.3  | 8.65                         | 9.1 | 9.56 | 1.0                    | -   | -                                      | -                   | 14  | 1.7  | 7.5                       |

(V<sub>F</sub> = 0.9 V Max @ I<sub>F</sub> = 10 mA) (5% Tolerance)

**40 WATTS**

| Device*          | Device Marking | V <sub>RWM</sub><br>Volts | I <sub>R</sub> @<br>V <sub>RWM</sub><br>nA | Breakdown Voltage            |     |       |                        | V <sub>C</sub> @ I <sub>PP</sub> (Note 6) |                      | ΘV <sub>BR</sub><br>mV/°C |
|------------------|----------------|---------------------------|--|------------------------------|-----|-------|------------------------|---|----------------------|---------------------------|
|                  |                |                           |  | V <sub>BR</sub> (Note 4) (V) |     |       | @ I <sub>T</sub><br>mA | V <sub>C</sub><br>V                       | I <sub>PP</sub><br>A |                           |
|                  |                |                           |  | Min                          | Nom | Max   |                        |   |                      |                           |
| MMBZ12VALT1G     | 12A            | 8.5                       | 200  | 11.40                        | 12  | 12.60 | 1.0                    | 17  | 2.35                 | 7.5                       |
| MMBZ15VALT1G     | 15A            | 12                        | 50   | 14.25                        | 15  | 15.75 | 1.0                    | 21  | 1.9                  | 12.3                      |
| MMBZ16VALT1G     | 16A            | 13                        | 50   | 15.20                        | 16  | 16.80 | 1.0                    | 23  | 1.7                  | 13.8                      |
| MMBZ18VALT1G     | 18A            | 14.5                      | 50   | 17.10                        | 18  | 18.90 | 1.0                    | 25  | 1.6                  | 15.3                      |
| MMBZ20VALT1G     | 20A            | 17                        | 50   | 19.00                        | 20  | 21.00 | 1.0                    | 28  | 1.4                  | 17.2                      |
| MMBZ27VALT1G/T3G | 27A            | 22                        | 50   | 25.65                        | 27  | 28.35 | 1.0                    | 40  | 1.0                  | 24.3                      |
| MMBZ33VALT1G     | 33A            | 26                        | 50   | 31.35                        | 33  | 34.65 | 1.0                    | 46  | 0.87                 | 30.4                      |
| MMBZ47VALT1G     | 47A            | 38                        | 50   | 44.65                        | 47  | 49.35 | 1.0                    | 54  | 0.74                 | 43.1                      |

(V<sub>F</sub> = 0.9 V Max @ I<sub>F</sub> = 10 mA) (2% Tolerance)

**40 WATTS**

| Device*       | Device Marking | V <sub>RWM</sub><br>Volts | I <sub>R</sub> @<br>V <sub>RWM</sub><br>nA | Breakdown Voltage            |     |       |                        | V <sub>C</sub> @ I <sub>PP</sub> (Note 6) |                      | ΘV <sub>BR</sub><br>mV/°C |
|---------------|----------------|---------------------------|--|------------------------------|-----|-------|------------------------|---|----------------------|---------------------------|
|               |                |                           |  | V <sub>BR</sub> (Note 4) (V) |     |       | @ I <sub>T</sub><br>mA | V <sub>C</sub><br>V                       | I <sub>PP</sub><br>A |                           |
|               |                |                           |  | Min                          | Nom | Max   |                        |   |                      |                           |
| MMBZ16VTALT1G | 16T            | 13                        | 50   | 15.68                        | 16  | 16.32 | 1.0                    | 23  | 1.7                  | 13.8                      |
| MMBZ47VTALT1G | 47T            | 38                        | 50   | 46.06                        | 47  | 47.94 | 1.0                    | 54  | 0.74                 | 43.1                      |

Product parametric performance is indicated in the Electrical Characteristics for the listed test conditions, unless otherwise noted. Product performance may not be indicated by the Electrical Characteristics if operated under different conditions.

4. V<sub>BR</sub> measured at pulse test current I<sub>T</sub> at an ambient temperature of 25°C.

5. Z<sub>ZT</sub> and Z<sub>ZK</sub> are measured by dividing the AC voltage drop across the device by the AC current applied. The specified limits are for I<sub>Z(AC)</sub> = 0.1 I<sub>Z(DC)</sub>, with the AC frequency = 1.0 kHz.

6. Surge current waveform per Figure 6 and derate per Figure 7

\* Include SZ-prefix devices where applicable.

# MMBZxxxALT1G Series, SZMMBZxxxALT1G Series

## TYPICAL CHARACTERISTICS



**Figure 1. Typical Breakdown Voltage versus Temperature**

(Upper curve for each voltage is bidirectional mode, lower curve is unidirectional mode)

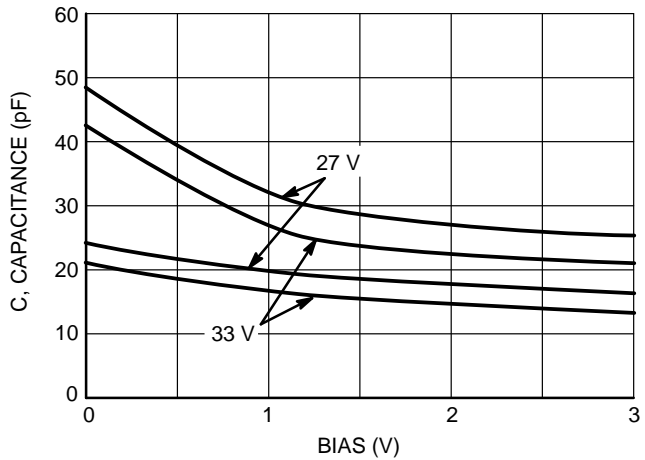

**Figure 2. Typical Leakage Current versus Temperature**



**Figure 3. Typical Capacitance versus Bias Voltage**

(Upper curve for each voltage is unidirectional mode, lower curve is bidirectional mode)



**Figure 4. Typical Capacitance versus Bias Voltage**

(Upper curve for each voltage is unidirectional mode, lower curve is bidirectional mode)

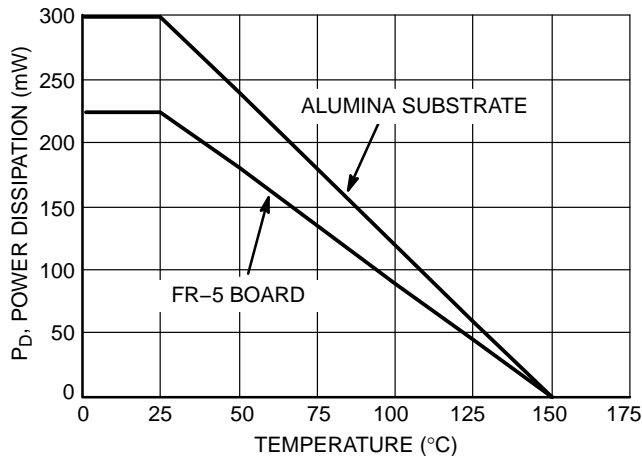

**Figure 5. Steady State Power Derating Curve**

TYPICAL CHARACTERISTICS

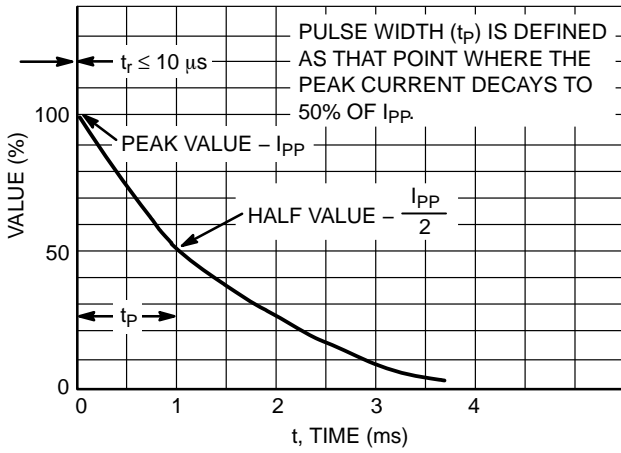

Figure 6. Pulse Waveform

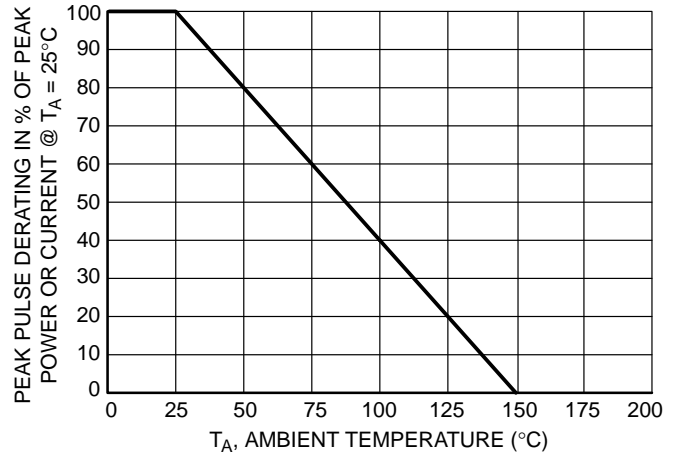

Figure 7. Pulse Derating Curve

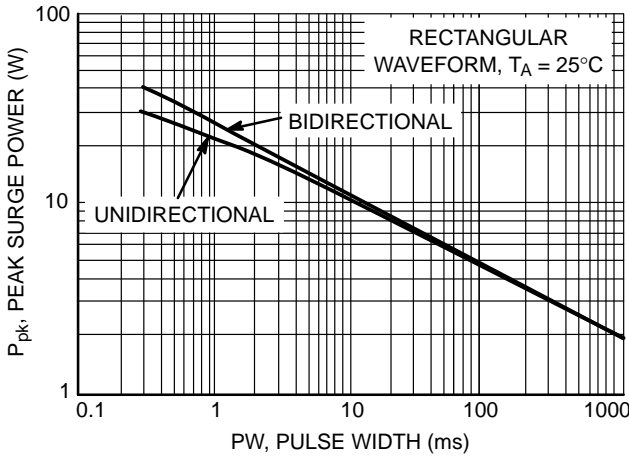

Figure 8. Maximum Non-repetitive Surge Power,  $P_{pk}$  versus PW

Power is defined as  $V_{RSM} \times I_{Z(pk)}$  where  $V_{RSM}$  is the clamping voltage at  $I_{Z(pk)}$ .

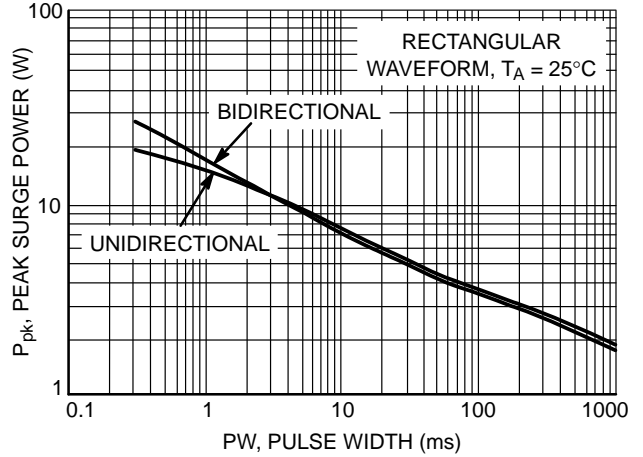

Figure 9. Maximum Non-repetitive Surge Power,  $P_{pk(NOM)}$  versus PW

Power is defined as  $V_Z(NOM) \times I_{Z(pk)}$  where  $V_Z(NOM)$  is the nominal Zener voltage measured at the low test current used for voltage classification.

# MMBZxxxALT1G Series, SZMMBZxxxALT1G Series

## TYPICAL COMMON ANODE APPLICATIONS

A dual junction common anode design in a SOT-23 package protects two separate lines using only one package. This adds flexibility and creativity to PCB design especially

when board space is at a premium. Two simplified examples of ESD applications are illustrated below.

### Computer Interface Protection



### Microprocessor Protection

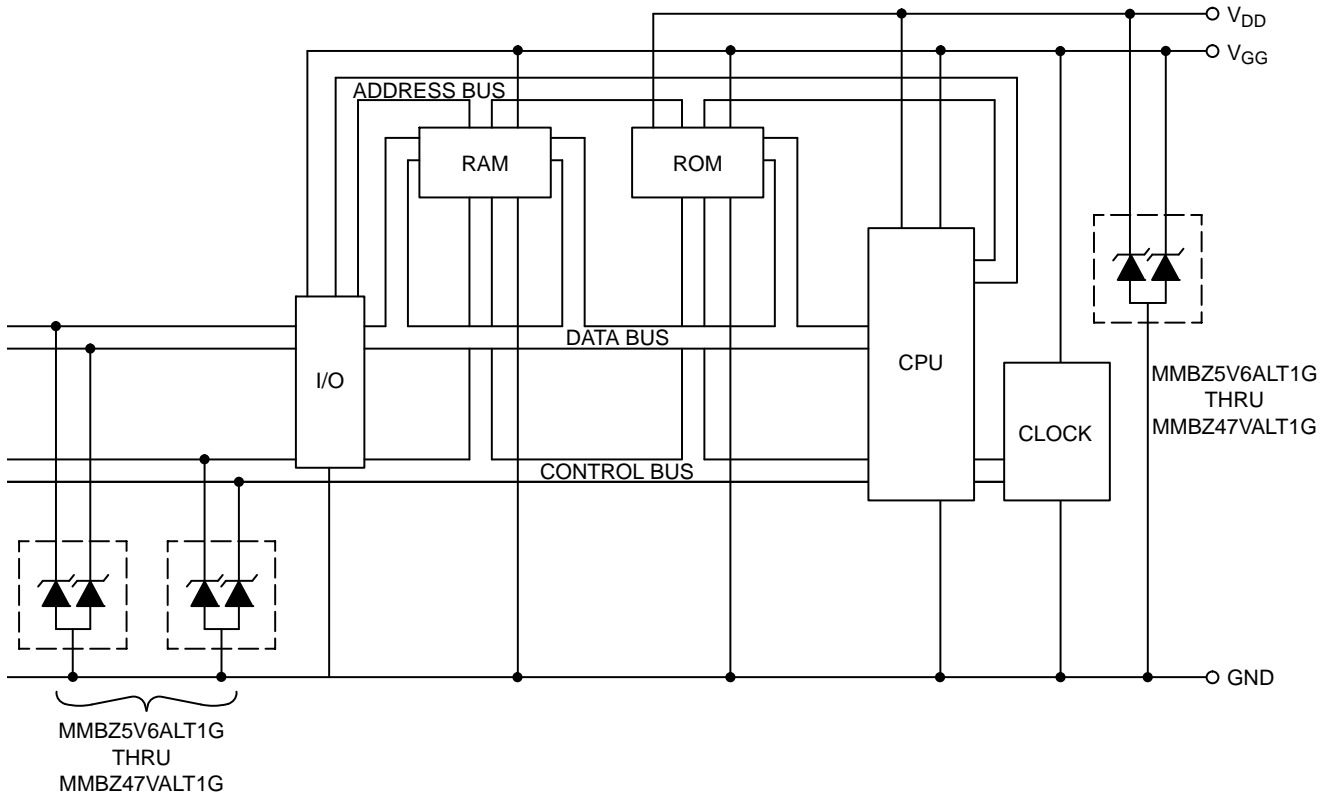

# MECHANICAL CASE OUTLINE

## PACKAGE DIMENSIONS

ON Semiconductor®



**SOT-23 (TO-236)**  
**CASE 318-08**  
**ISSUE AS**

DATE 30 JAN 2018

SCALE 4:1

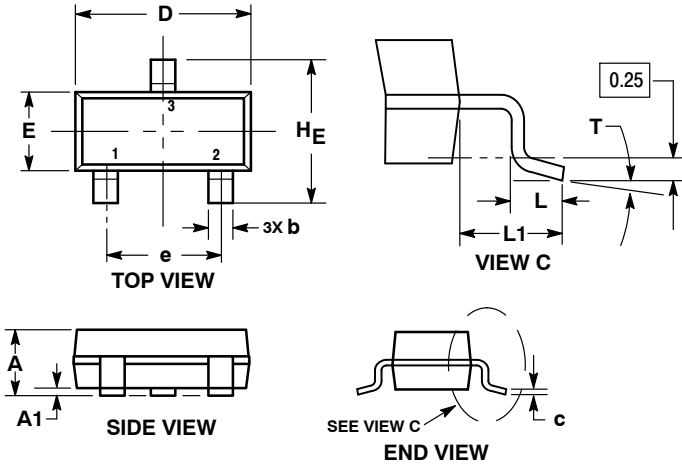

**NOTES:**

1. DIMENSIONING AND TOLERANCING PER ASME Y14.5M, 1994.
2. CONTROLLING DIMENSION: MILLIMETERS.
3. MAXIMUM LEAD THICKNESS INCLUDES LEAD FINISH. MINIMUM LEAD THICKNESS IS THE MINIMUM THICKNESS OF THE BASE MATERIAL.
4. DIMENSIONS D AND E DO NOT INCLUDE MOLD FLASH, PROTRUSIONS, OR GATE BURRS.

| DIM | MILLIMETERS |      |      | INCHES |       |       |
|-----|-------------|------|------|--------|-------|-------|
|     | MIN         | NOM  | MAX  | MIN    | NOM   | MAX   |
| A   | 0.89        | 1.00 | 1.11 | 0.035  | 0.039 | 0.044 |
| A1  | 0.01        | 0.06 | 0.10 | 0.000  | 0.002 | 0.004 |
| b   | 0.37        | 0.44 | 0.50 | 0.015  | 0.017 | 0.020 |
| c   | 0.08        | 0.14 | 0.20 | 0.003  | 0.006 | 0.008 |
| D   | 2.80        | 2.90 | 3.04 | 0.110  | 0.114 | 0.120 |
| E   | 1.20        | 1.30 | 1.40 | 0.047  | 0.051 | 0.055 |
| e   | 1.78        | 1.90 | 2.04 | 0.070  | 0.075 | 0.080 |
| L   | 0.30        | 0.43 | 0.55 | 0.012  | 0.017 | 0.022 |
| L1  | 0.35        | 0.54 | 0.69 | 0.014  | 0.021 | 0.027 |
| HE  | 2.10        | 2.40 | 2.64 | 0.083  | 0.094 | 0.104 |
| T   | 0°          | ---  | 10°  | 0°     | ---   | 10°   |

**RECOMMENDED SOLDERING FOOTPRINT**

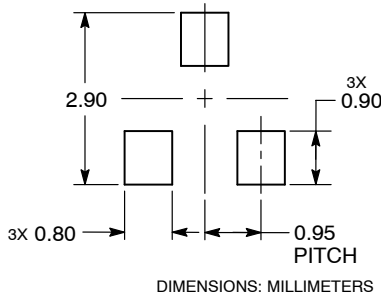

**GENERIC MARKING DIAGRAM\***

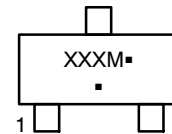

XXX = Specific Device Code  
 M = Date Code  
 ■ = Pb-Free Package

\*This information is generic. Please refer to device data sheet for actual part marking. Pb-Free indicator, "G" or microdot "■", may or may not be present.

STYLE 1 THRU 5:  
 CANCELLED

STYLE 6:  
 PIN 1. BASE  
 2. EMITTER  
 3. COLLECTOR

STYLE 7:  
 PIN 1. EMITTER  
 2. BASE  
 3. COLLECTOR

STYLE 8:  
 PIN 1. ANODE  
 2. NO CONNECTION  
 3. CATHODE

STYLE 9:  
 PIN 1. ANODE  
 2. ANODE  
 3. CATHODE

STYLE 10:  
 PIN 1. DRAIN  
 2. SOURCE  
 3. GATE

STYLE 11:  
 PIN 1. ANODE  
 2. CATHODE  
 3. CATHODE-ANODE

STYLE 12:  
 PIN 1. CATHODE  
 2. CATHODE  
 3. ANODE

STYLE 13:  
 PIN 1. SOURCE  
 2. DRAIN  
 3. GATE

STYLE 14:  
 PIN 1. CATHODE  
 2. GATE  
 3. ANODE

STYLE 15:  
 PIN 1. GATE  
 2. CATHODE  
 3. ANODE

STYLE 16:  
 PIN 1. ANODE  
 2. CATHODE  
 3. CATHODE

STYLE 17:  
 PIN 1. NO CONNECTION  
 2. ANODE  
 3. CATHODE

STYLE 18:  
 PIN 1. NO CONNECTION  
 2. CATHODE  
 3. ANODE

STYLE 19:  
 PIN 1. CATHODE  
 2. ANODE  
 3. CATHODE-ANODE

STYLE 20:  
 PIN 1. CATHODE  
 2. ANODE  
 3. GATE

STYLE 21:  
 PIN 1. GATE  
 2. SOURCE  
 3. DRAIN

STYLE 22:  
 PIN 1. RETURN  
 2. OUTPUT  
 3. INPUT

STYLE 23:  
 PIN 1. ANODE  
 2. ANODE  
 3. CATHODE

STYLE 24:  
 PIN 1. GATE  
 2. DRAIN  
 3. SOURCE

STYLE 25:  
 PIN 1. ANODE  
 2. CATHODE  
 3. GATE

STYLE 26:  
 PIN 1. CATHODE  
 2. ANODE  
 3. NO CONNECTION

STYLE 27:  
 PIN 1. CATHODE  
 2. CATHODE  
 3. CATHODE

STYLE 28:  
 PIN 1. ANODE  
 2. ANODE  
 3. ANODE

|                         |                        |  |
|-------------------------|------------------------|--|
| <b>DOCUMENT NUMBER:</b> | <b>98ASB42226B</b>     | Electronic versions are uncontrolled except when accessed directly from the Document Repository. Printed versions are uncontrolled except when stamped "CONTROLLED COPY" in red. |
| <b>DESCRIPTION:</b>     | <b>SOT-23 (TO-236)</b> | <b>PAGE 1 OF 1</b>   |

ON Semiconductor and ON are trademarks of Semiconductor Components Industries, LLC dba ON Semiconductor or its subsidiaries in the United States and/or other countries. ON Semiconductor reserves the right to make changes without further notice to any products herein. ON Semiconductor makes no warranty, representation or guarantee regarding the suitability of its products for any particular purpose, nor does ON Semiconductor assume any liability arising out of the application or use of any product or circuit, and specifically disclaims any and all liability, including without limitation special, consequential or incidental damages. ON Semiconductor does not convey any license under its patent rights nor the rights of others.

**onsemi**, **Onsemi**, and other names, marks, and brands are registered and/or common law trademarks of Semiconductor Components Industries, LLC dba "**onsemi**" or its affiliates and/or subsidiaries in the United States and/or other countries. **onsemi** owns the rights to a number of patents, trademarks, copyrights, trade secrets, and other intellectual property. A listing of **onsemi**'s product/patent coverage may be accessed at [www.onsemi.com/site/pdf/Patent-Marking.pdf](http://www.onsemi.com/site/pdf/Patent-Marking.pdf). **onsemi** reserves the right to make changes at any time to any products or information herein, without notice. The information herein is provided "as-is" and **onsemi** makes no warranty, representation or guarantee regarding the accuracy of the information, product features, availability, functionality, or suitability of its products for any particular purpose, nor does **onsemi** assume any liability arising out of the application or use of any product or circuit, and specifically disclaims any and all liability, including without limitation special, consequential or incidental damages. Buyer is responsible for its products and applications using **onsemi** products, including compliance with all laws, regulations and safety requirements or standards, regardless of any support or applications information provided by **onsemi**. "Typical" parameters which may be provided in **onsemi** data sheets and/or specifications can and do vary in different applications and actual performance may vary over time. All operating parameters, including "Typicals" must be validated for each customer application by customer's technical experts. **onsemi** does not convey any license under any of its intellectual property rights nor the rights of others. **onsemi** products are not designed, intended, or authorized for use as a critical component in life support systems or any FDA Class 3 medical devices or medical devices with a same or similar classification in a foreign jurisdiction or any devices intended for implantation in the human body. Should Buyer purchase or use **onsemi** products for any such unintended or unauthorized application, Buyer shall indemnify and hold **onsemi** and its officers, employees, subsidiaries, affiliates, and distributors harmless against all claims, costs, damages, and expenses, and reasonable attorney fees arising out of, directly or indirectly, any claim of personal injury or death associated with such unintended or unauthorized use, even if such claim alleges that **onsemi** was negligent regarding the design or manufacture of the part. **onsemi** is an Equal Opportunity/Affirmative Action Employer. This literature is subject to all applicable copyright laws and is not for resale in any manner.

## PUBLICATION ORDERING INFORMATION

### LITERATURE FULFILLMENT:

Email Requests to: [orderlit@onsemi.com](mailto:orderlit@onsemi.com)

**onsemi Website:** [www.onsemi.com](http://www.onsemi.com)

### TECHNICAL SUPPORT

**North American Technical Support:**  
Voice Mail: 1 800-282-9855 Toll Free USA/Canada  
Phone: 011 421 33 790 2910

**Europe, Middle East and Africa Technical Support:**

Phone: 00421 33 790 2910

For additional information, please contact your local Sales Representative

