

Standard Recovery Diodes (Stud Version), 300 A



DO-205AB (DO-9)

FEATURES

- Wide current range
- High voltage rating up to 2500 V
- High surge current capabilities
- Stud cathode and stud anode version
- High resistance to acceleration
- Designed and qualified for industrial level
- Material categorization: For definitions of compliance please see www.vishay.com/doc?99912

RoHS
COMPLIANT

TYPICAL APPLICATIONS

- Converters
- Power supplies
- Machine tool controls
- High power drives
- Medium traction applications

PRODUCT SUMMARY

$I_{F(AV)}$	300 A
-------------	-------

MAJOR RATINGS AND CHARACTERISTICS

PARAMETER	TEST CONDITIONS	301U(R)		UNITS
		160 TO 200	250	
$I_{F(AV)}$		330	300	A
	T_C	120	120	°C
$I_{F(RMS)}$		520	470	A
I_{FSM}	50 Hz	8250	6050	A
	60 Hz	8640	6335	
I^2t	50 Hz	340	183	kA ² s
	60 Hz	311	167	
V_{RRM}	Range	1600 to 2000	2500	V
T_J		- 40 to 180	- 40 to 180	°C

ELECTRICAL SPECIFICATIONS

VOLTAGE RATINGS

TYPE NUMBER	VOLTAGE CODE	V_{RRM} , MAXIMUM REPETITIVE PEAK REVERSE VOLTAGE V	V_{RSM} , MAXIMUM NON-REPETITIVE PEAK REVERSE VOLTAGE V	I_{RRM} MAXIMUM AT $T_J = T_J$ MAXIMUM mA
301U(R)	160	1600	1700	15
	200	2000	2100	
	250	2500	2600	



FORWARD CONDUCTION							
PARAMETER	SYMBOL	TEST CONDITIONS		301U(R)		UNITS	
				160 TO 200	250		
Maximum average forward current at case temperature	$I_{F(AV)}$	180° conduction, half sine wave		330	300	A	
				120	120	°C	
Maximum RMS forward current	$I_{F(RMS)}$	DC at $T_C = 115\text{ °C}$ (up to 2000 V), $T_C = 102\text{ °C}$ (2500 V)		520	470	A	
Maximum peak, one cycle forward, non-repetitive surge current	I_{FSM}	t = 10 ms	No voltage reappplied	Sinusoidal half wave, initial $T_J = T_J$ maximum	8250	6050	A
		t = 8.3 ms			8640	6335	
		t = 10 ms	100 % V_{RRM} reappplied		6940	5090	
		t = 8.3 ms			7270	5330	
Maximum I^2t for fusing	I^2t	t = 10 ms	No voltage reappplied	Sinusoidal half wave, initial $T_J = T_J$ maximum	340	183	kA ² s
		t = 8.3 ms			311	167	
		t = 10 ms	100 % V_{RRM} reappplied		241	129	
		t = 8.3 ms			220	118	
Maximum $I^2\sqrt{t}$ for fusing	$I^2\sqrt{t}$	t = 0.1 to 10 ms, no voltage reappplied		3400	1830	kA ² √s	
Low level value of threshold voltage	$V_{F(TO)1}$	$(16.7\% \times \pi \times I_{F(AV)} < I < \pi \times I_{F(AV)})$, $T_J = T_J$ maximum		0.77	0.90	V	
High level value of threshold voltage	$V_{F(TO)2}$	$(I > \pi \times I_{F(AV)})$, $T_J = T_J$ maximum		0.84	0.97		
Low level value of forward slope resistance	r_{f1}	$(16.7\% \times \pi \times I_{F(AV)} < I < \pi \times I_{F(AV)})$, $T_J = T_J$ maximum		0.49	0.59	mΩ	
High level value of forward slope resistance	r_{f2}	$(I > \pi \times I_{F(AV)})$, $T_J = T_J$ maximum		0.49	0.55		
Maximum forward voltage drop	V_{FM}	$I_{pk} = 942\text{ A}$, $T_J = T_J$ maximum, $t_p = 10\text{ ms}$ sinusoidal wave		1.22	1.46	V	

THERMAL AND MECHANICAL SPECIFICATIONS				
PARAMETER	SYMBOL	TEST CONDITIONS	VALUES	UNITS
Maximum junction operating temperature range	T_J		- 40 to 180	°C
Maximum storage temperature range	T_{Stg}		- 40 to 200	
Maximum thermal resistance, junction to case	R_{thJC}	DC operation	0.14	K/W
Maximum thermal resistance, case to heatsink	R_{thCS}	Mounting surface, smooth, flat and greased	0.08	
Maximum allowed mounting torque + 0 - 20 %		Not lubricated threads	37	N · m
		Lubricated threads	28	
Weight	301U		250 ± 5	g
	303U		152 ± 5	
	305U		177 ± 5	
	307U		197 ± 5	
	309U		160 ± 5	
Case style		See dimensions - link at the end of datasheet	DO-205AB (DO-9)	

ΔR_{thJC} CONDUCTION						
CONDUCTION ANGLE	SINUSOIDAL CONDUCTION		RECTANGULAR CONDUCTION		TEST CONDITIONS	UNITS
	80 TO 200	250	80 TO 200	250		
180°	0.015	0.015	0.011	0.011	$T_J = T_J$ maximum	K/W
120°	0.018	0.018	0.019	0.019		
90°	0.023	0.023	0.025	0.025		
60°	0.034	0.034	0.035	0.035		
30°	0.056	0.056	0.057	0.057		

Note

- The table above shows the increment of thermal resistance R_{thJC} when devices operate at different conduction angles than DC

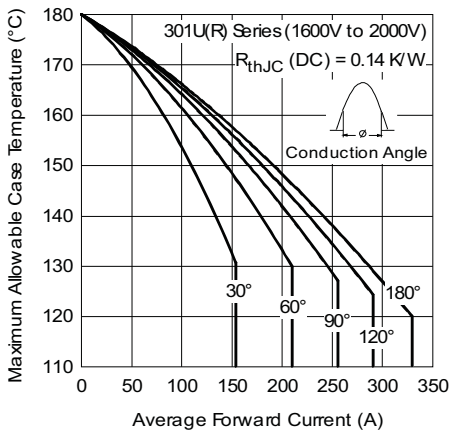

Fig. 1 - Current Ratings Characteristics

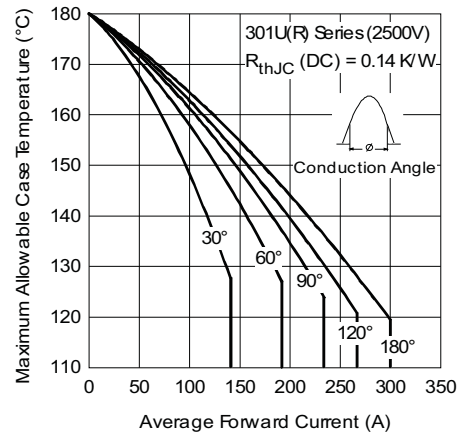

Fig. 2 - Current Ratings Characteristics

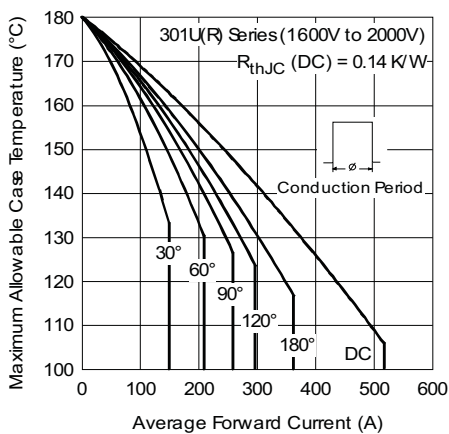

Fig. 1 - Current Ratings Characteristics

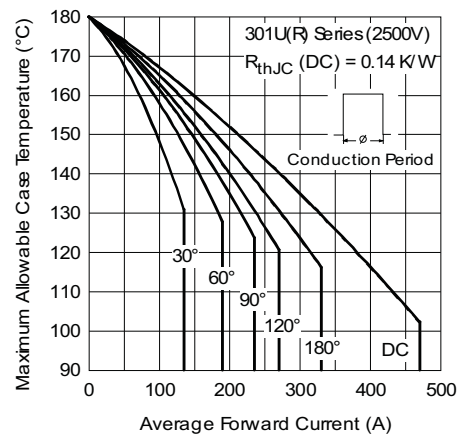

Fig. 3 - Current Ratings Characteristics

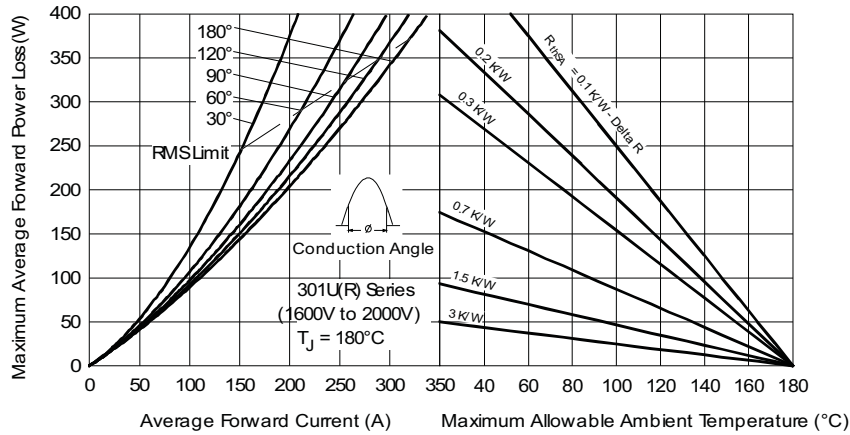

Fig. 4 - Forward Power Loss Characteristics

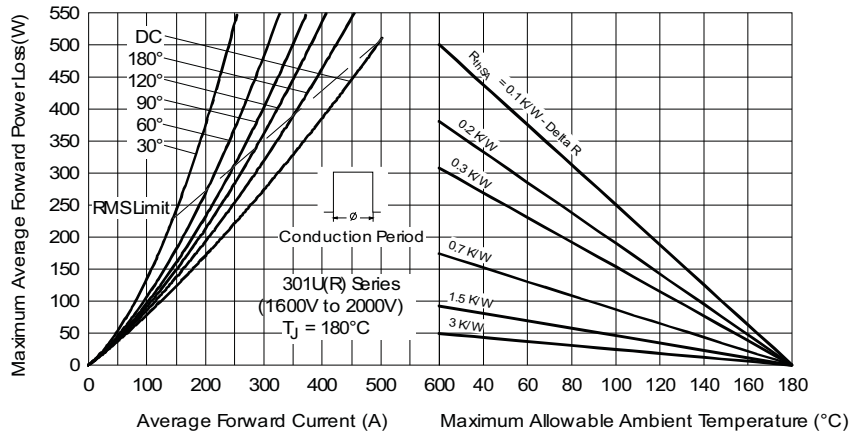

Fig. 5 - Forward Power Loss Characteristics

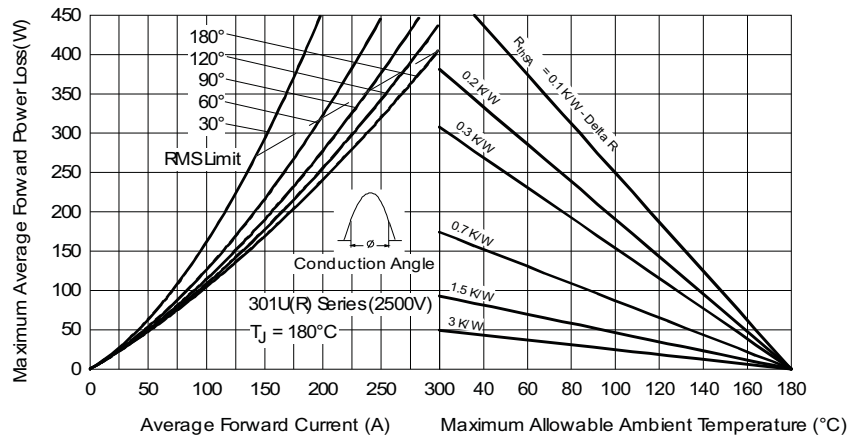

Fig. 6 - Forward Power Loss Characteristics

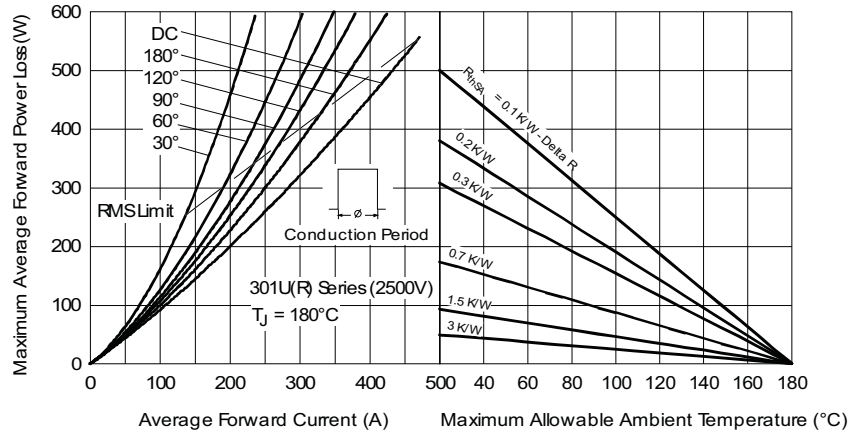

Fig. 7 - Forward Power Loss Characteristics

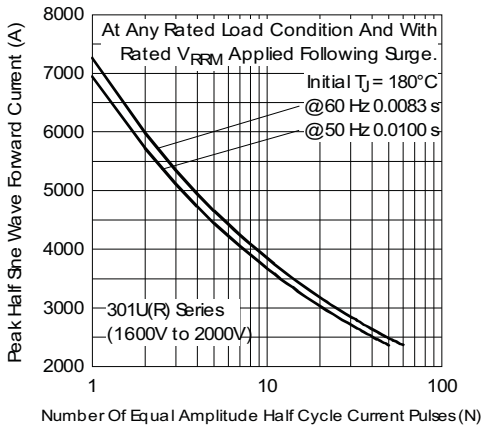

Fig. 8 - Maximum Non-Repetitive Surge Current

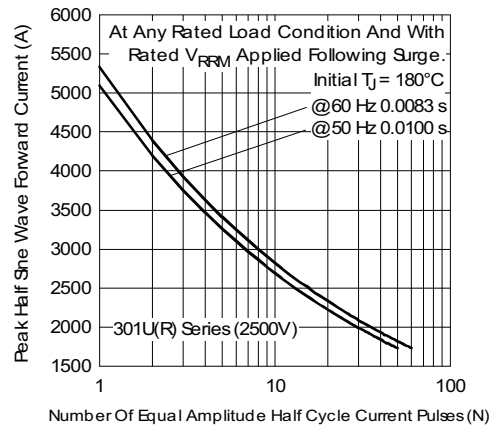

Fig. 10 - Maximum Non-Repetitive Surge Current

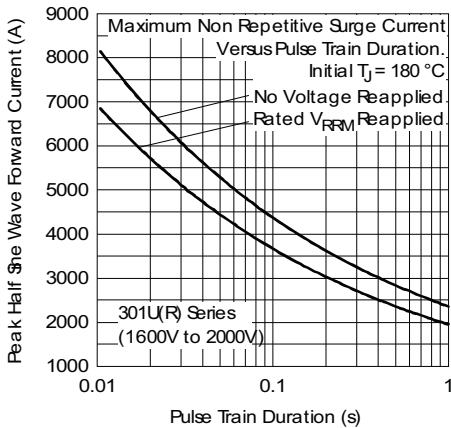

Fig. 9 - Maximum Non-Repetitive Surge Current

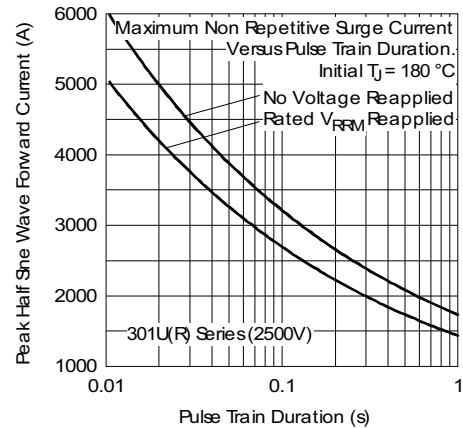

Fig. 11 - Maximum Non-Repetitive Surge Current

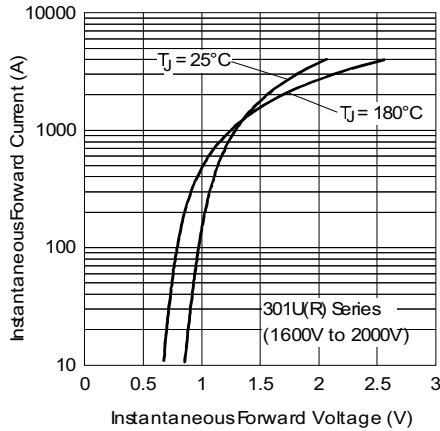

Fig. 12 - Forward Voltage Drop Characteristics

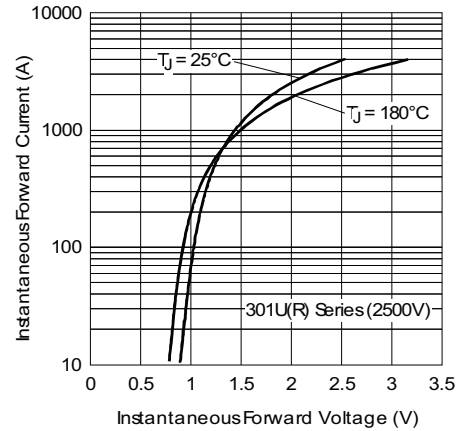

Fig. 13 - Forward Voltage Drop Characteristics

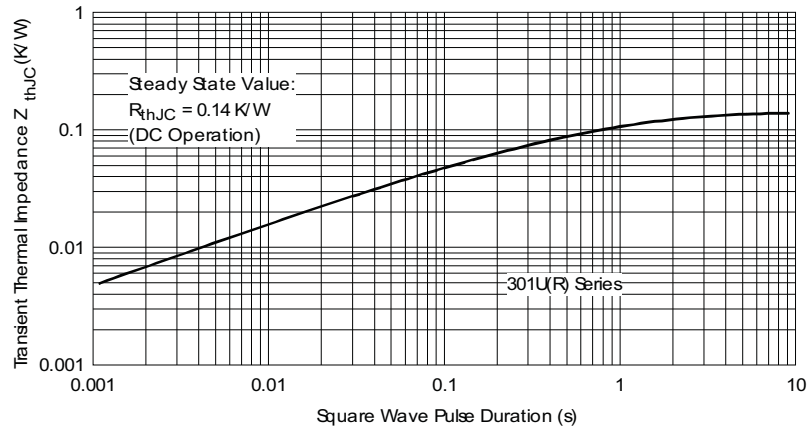
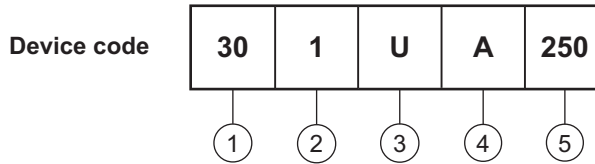

Fig. 14 - Thermal Impedance Z_{thJC} Characteristic



ORDERING INFORMATION TABLE



- 1** - 30 = Essential part number
- 2** -
 - 1 = Standard device
 - 3 = Top threaded version
 - 5 = Type for rotating application with top threaded version 3/8 16UNC-2A
 - 7 = Type for rotating application with flexible lead
 - 9 = Type for rotating application with top threaded version 3/8 24UNF
- 3** -
 - U = Stud normal polarity (cathode to stud)
 - UR = Stud reverse polarity (anode to stud)
- 4** - A = Maximum leakage selection $I_{RRM} = 2 \text{ mA } T_J = 25 \text{ }^\circ\text{C}$
- 5** - Voltage code x 10 = V_{RRM} (see Voltage Ratings table)

LINKS TO RELATED DOCUMENTS	
Dimensions	www.vishay.com/doc?95337

DO-205AB (DO-9), B-60, B-61, B-41, B-40 for 301U(R), 307U(R), 305U(R) and 309U(R) Series

DIMENSIONS FOR 301U(R) SERIES - DO-205AB (DO-9) in millimeters (inches)



Outline Dimensions



Vishay Semiconductors DO-205AB (DO-9), B-60, B-61, B-41, B-40 for 301U(R), 307U(R), 305U(R) and 309U(R) Series

DIMENSIONS FOR 307U(R) SERIES - B-60 in millimeters (inches)

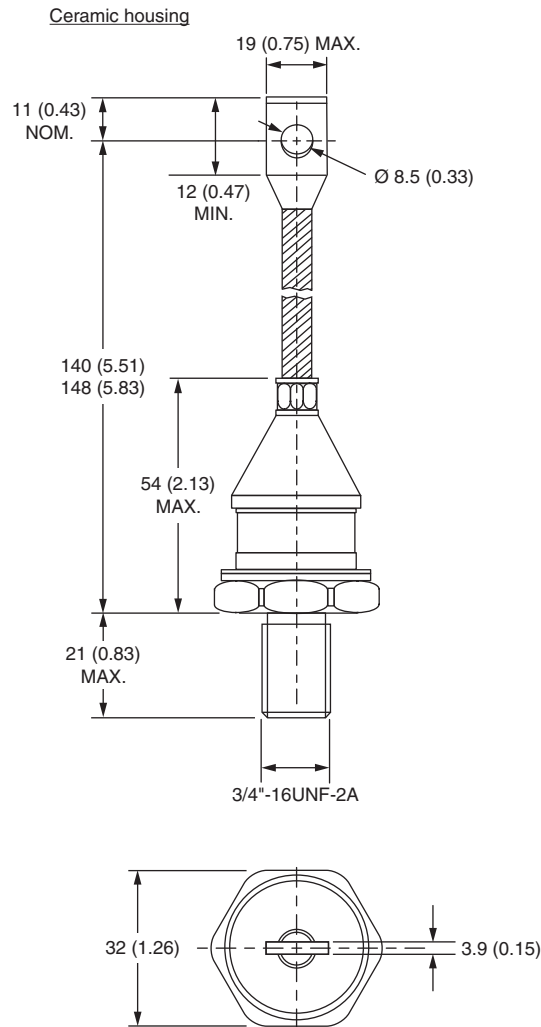



DIMENSIONS FOR 305U(R) SERIES - B-61 in millimeters (inches)



DIMENSIONS FOR 309U(R) SERIES - B-41 in millimeters (inches)

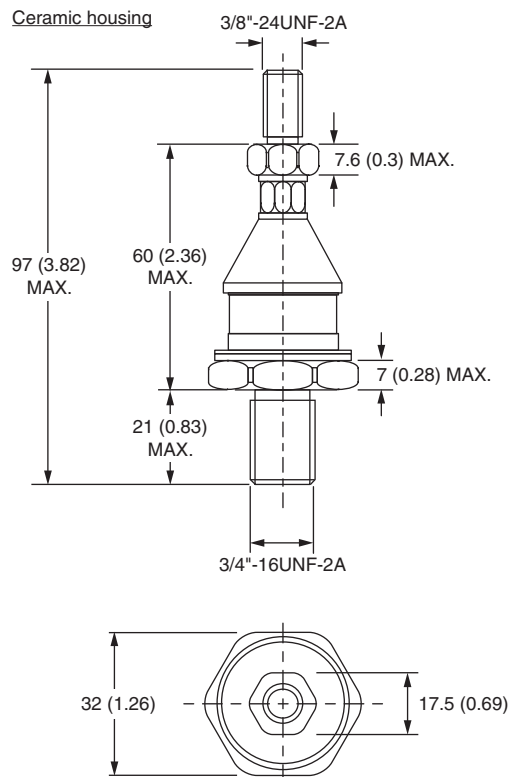

Outline Dimensions



Vishay Semiconductors DO-205AB (DO-9), B-60, B-61, B-41, B-40 for 301U(R), 307U(R), 305U(R) and 309U(R) Series

DIMENSIONS FOR 303U(R) SERIES - B-40 in millimeters (inches)





Disclaimer

ALL PRODUCT, PRODUCT SPECIFICATIONS AND DATA ARE SUBJECT TO CHANGE WITHOUT NOTICE TO IMPROVE RELIABILITY, FUNCTION OR DESIGN OR OTHERWISE.

Vishay Intertechnology, Inc., its affiliates, agents, and employees, and all persons acting on its or their behalf (collectively, "Vishay"), disclaim any and all liability for any errors, inaccuracies or incompleteness contained in any datasheet or in any other disclosure relating to any product.

Vishay makes no warranty, representation or guarantee regarding the suitability of the products for any particular purpose or the continuing production of any product. To the maximum extent permitted by applicable law, Vishay disclaims (i) any and all liability arising out of the application or use of any product, (ii) any and all liability, including without limitation special, consequential or incidental damages, and (iii) any and all implied warranties, including warranties of fitness for particular purpose, non-infringement and merchantability.

Statements regarding the suitability of products for certain types of applications are based on Vishay's knowledge of typical requirements that are often placed on Vishay products in generic applications. Such statements are not binding statements about the suitability of products for a particular application. It is the customer's responsibility to validate that a particular product with the properties described in the product specification is suitable for use in a particular application. Parameters provided in datasheets and/or specifications may vary in different applications and performance may vary over time. All operating parameters, including typical parameters, must be validated for each customer application by the customer's technical experts. Product specifications do not expand or otherwise modify Vishay's terms and conditions of purchase, including but not limited to the warranty expressed therein.

Except as expressly indicated in writing, Vishay products are not designed for use in medical, life-saving, or life-sustaining applications or for any other application in which the failure of the Vishay product could result in personal injury or death. Customers using or selling Vishay products not expressly indicated for use in such applications do so at their own risk. Please contact authorized Vishay personnel to obtain written terms and conditions regarding products designed for such applications.

No license, express or implied, by estoppel or otherwise, to any intellectual property rights is granted by this document or by any conduct of Vishay. Product names and markings noted herein may be trademarks of their respective owners.

Material Category Policy

Vishay Intertechnology, Inc. hereby certifies that all its products that are identified as RoHS-Compliant fulfill the definitions and restrictions defined under Directive 2011/65/EU of The European Parliament and of the Council of June 8, 2011 on the restriction of the use of certain hazardous substances in electrical and electronic equipment (EEE) - recast, unless otherwise specified as non-compliant.

Please note that some Vishay documentation may still make reference to RoHS Directive 2002/95/EC. We confirm that all the products identified as being compliant to Directive 2002/95/EC conform to Directive 2011/65/EU.

Vishay Intertechnology, Inc. hereby certifies that all its products that are identified as Halogen-Free follow Halogen-Free requirements as per JEDEC JS709A standards. Please note that some Vishay documentation may still make reference to the IEC 61249-2-21 definition. We confirm that all the products identified as being compliant to IEC 61249-2-21 conform to JEDEC JS709A standards.