

Overview

Polyphenylene sulphide (PPS) film capacitor for surface mounting. Encapsulation in self-extinguishing material meeting the requirements of UL 94 V-0. SMC capacitors meet the standards according to IEC 60384-20.

Applications

Typical applications include timing, filtering and use as a memory capacitor. The SMC Series is designed for high stability, accuracy and temperature. Not suitable for across-the-line application (see suppressor capacitors).

Benefits

- Rated voltage: 50 – 400 VDC
- Rated voltage: 30 – 200 VAC
- Capacitance range: 0.001 – 3.3 μ F
- EIA size: 2220 – 6560
- Capacitance tolerance: \pm 2%, \pm 2.5%, \pm 5%
- Climatic category: 55/125/56
- RoHS Compliant and lead-free terminations
- Operating temperature range of -55°C to +125°C

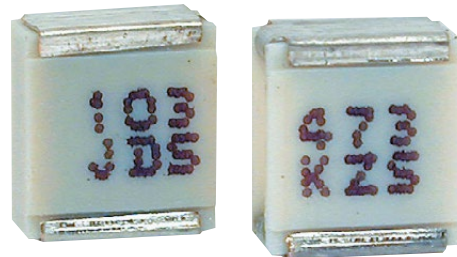

Legacy Part Number System

SMC	5.7	102	J	50	J31	TR12
Series	Chip Length (mm)	Capacitance Code (pF)	Capacitance Tolerance	Rated Voltage (VDC)	Size Code	Packaging
Metallized PPS	5.7 7.3 10.2 12.7 16.5	First two digits represent significant figures. The third digit specifies number of zeros.	G = \pm 2% H = \pm 2.5% J = \pm 5%	50 100 250 400	See Dimension Table	See Ordering Options Table

New KEMET Part Number System

F	125	P	L	102	J	050	V
Capacitor Class	Series	Chip Size	Size Code	Capacitance Code (pF)	Capacitance Tolerance	Rated Voltage (VDC)	Packaging
F = Film	Metallized PPS	P = 2220 S = 2820 W = 4036 Y = 5045 Z = 6560	See Dimension Table	First two digits represent significant figures. The third digit specifies number of zeros.	G = \pm 2% R = \pm 2.5% J = \pm 5%	050 = 50 100 = 100 250 = 250 400 = 400	See Ordering Options Table

Ordering Options Table

Chip Size (EIA)	Packaging Type	KEMET Packaging Code	Legacy Packaging Code
2220	Standard Packaging Options		
	Tape & Reel (Standard Reel)	V	TR12
	Bulk (Bag)	A	BULK
2824	Standard Packaging Options		
	Tape & Reel (Standard Reel)	V	TR12
	Bulk (Bag)	A	BULK
4036	Standard Packaging Options		
	Tape & Reel (Horizontal Orientation Standard Reel)	V	TR16
	Bulk (Bag)	A	BULK
	Other Packaging Options		
	Tape & Reel (Vertical Orientation Standard Reel)	Y	TV24
5045	Standard Packaging Options		
	Tape & Reel (Standard Reel)	V	TR24
	Bulk (Bag)	A	BULK
	Other Packaging Options		
	Tape & Reel (Vertical Orientation Standard Reel)	Y	TV24
6560	Standard Packaging Options		
	Tape & Reel (Standard Reel)	V	TR24
	Bulk (Bag)	A	BULK
	Other Packaging Options		
	Tape & Reel (Vertical Orientation Standard Reel)	Y	TV44

Dimensions – Millimeters

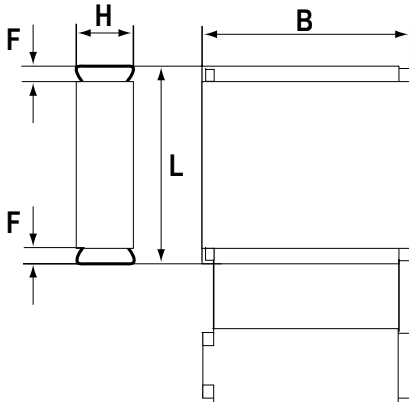

KEMET Size Code	Legacy Size Code	Chip Size (EIA)	B		H		L		F	
			Nominal	Tolerance	Nominal	Tolerance	Nominal	Tolerance	Nominal	Tolerance
PL	J31	2220	5.0	+/-0.2	2.5	+/-0.2	5.7	+/-0.2	0.5	Nominal
PP	J33	2220	5.0	+/-0.2	3.0	+/-0.2	5.7	+/-0.2	0.5	Nominal
PU	J35	2220	5.0	+/-0.2	4.0	+/-0.2	5.7	+/-0.2	0.5	Nominal
SG	K31	2824	6.0	+/-0.2	2.5	+/-0.2	7.3	+/-0.2	0.5	Nominal
SL	K33	2824	6.0	+/-0.2	3.0	+/-0.2	7.3	+/-0.2	0.5	Nominal
SP	K35	2824	6.0	+/-0.2	3.5	+/-0.2	7.3	+/-0.2	0.5	Nominal
ST	K37	2824	6.0	+/-0.2	4.5	+/-0.2	7.3	+/-0.2	0.5	Nominal
WP	A31	4036	9.1	+/-0.2	5.5	+/-0.2	10.2	+/-0.2	0.5	Nominal
YR	B31	5045	11.5	+/-0.2	6.5	+/-0.2	12.7	+/-0.2	0.5	Nominal
ZS	C31	6560	15	+/-0.2	7.0	+/-0.2	16.5	+/-0.2	0.5	Nominal

Environmental Compliance

All KEMET surface mount capacitors are RoHS Compliant.

Performance Characteristics

Rated Voltage (VDC)	50	100	250	400
Rated Voltage (VAC)	30	63	160	200
Capacitance Range (μF)	0.001 – 3.3	0.001 – 1.5	0.001 – 0.47	0.001 – 0.22
Chip Size (EIA)	2220 – 6560			
Capacitance Tolerance	$\pm 2\%$, $\pm 2.5\%$, $\pm 5\%$			
Category Temperature Range	-55°C to +125°C			
Rated Temperature	+100°C			
Voltage Derating	The rated voltage should be decreased with 1.25%/°C from +100°C to +125°C and 1.5%/°C from +125°C to 175°C			
Climatic Category	55/125/56			
Test Voltage	$1.6 \times V_R$, 60 seconds			
Insulation Resistance	Measured at +20°C According to IEC 60384-19			
	Minimum Value Between Terminals			
		$C \leq 0.33 \mu\text{F}$	$C > 0.33 \mu\text{F}$	
	$V_R \leq 100$	15,000 M Ω	5,000 M $\Omega \cdot \mu\text{F}$	
	$V_R > 100$	30,000 M Ω	10,000 M $\Omega \cdot \mu\text{F}$	
Dissipation Factor	Maximum Values at +23°C			
		$C \leq 0.1 \mu\text{F}$	$0.1 < C \leq 1 \mu\text{F}$	$C > 1 \mu\text{F}$
	1 kHz	0.15%	0.15%	0.15%
	10 kHz	0.25%	0.25%	0.30%
	100 kHz	0.50%	0.60%	
Pulse Rise Time	The capacitors can withstand an unlimited number of pulses with a dV/dt according to Table 1. For voltages (V) lower than the rated voltage (V_R), the specified dV/dt can be multiplied by V_R/V .			

Capacitance vs. Temperature

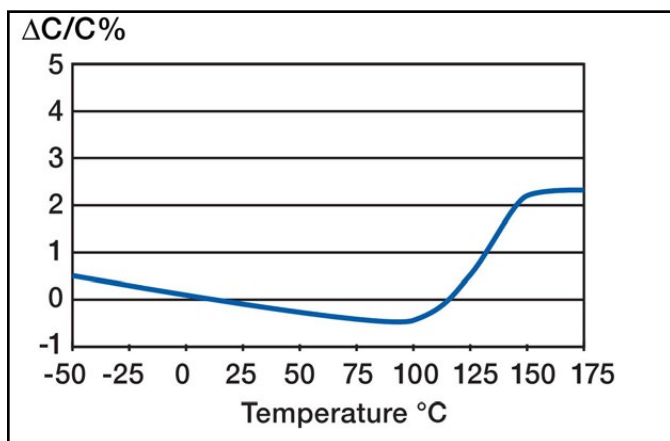

Dissipation Factor vs. Temperature

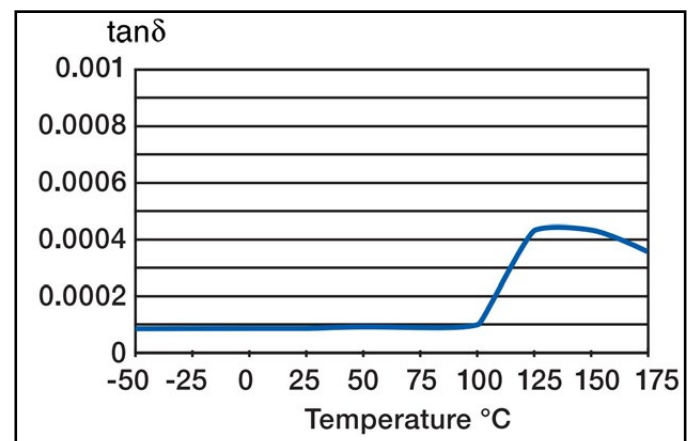

Table 1 – Ratings & Part Number Reference

VDC	VAC	Capacitance Value (µF)	Size Code (New/Legacy)	Dimensions in mm			Chip Size	dV/dt (V/µs)	New KEMET Part Number	Legacy Part Number
				B	H	L				
50	30	0.0010	PL/J31	5.0	2.5	5.7	2220	20	F125PL102(1)050(2)	SMC5.7102(1)50J31(2)
50	30	0.0012	PL/J31	5.0	2.5	5.7	2220	20	F125PL122(1)050(2)	SMC5.7122(1)50J31(2)
50	30	0.0015	PL/J31	5.0	2.5	5.7	2220	20	F125PL152(1)050(2)	SMC5.7152(1)50J31(2)
50	30	0.0018	PL/J31	5.0	2.5	5.7	2220	20	F125PL182(1)050(2)	SMC5.7182(1)50J31(2)
50	30	0.0022	PL/J31	5.0	2.5	5.7	2220	20	F125PL222(1)050(2)	SMC5.7222(1)50J31(2)
50	30	0.0027	PL/J31	5.0	2.5	5.7	2220	20	F125PL272(1)050(2)	SMC5.7272(1)50J31(2)
50	30	0.0033	PL/J31	5.0	2.5	5.7	2220	20	F125PL332(1)050(2)	SMC5.7332(1)50J31(2)
50	30	0.0039	PL/J31	5.0	2.5	5.7	2220	20	F125PL392(1)050(2)	SMC5.7392(1)50J31(2)
50	30	0.0047	PL/J31	5.0	2.5	5.7	2220	20	F125PL472(1)050(2)	SMC5.7472(1)50J31(2)
50	30	0.0056	PL/J31	5.0	2.5	5.7	2220	20	F125PL562(1)050(2)	SMC5.7562(1)50J31(2)
50	30	0.0068	PL/J31	5.0	2.5	5.7	2220	20	F125PL682(1)050(2)	SMC5.7682(1)50J31(2)
50	30	0.0082	PL/J31	5.0	2.5	5.7	2220	20	F125PL822(1)050(2)	SMC5.7822(1)50J31(2)
50	30	0.010	PL/J31	5.0	2.5	5.7	2220	20	F125PL103(1)050(2)	SMC5.7103(1)50J31(2)
50	30	0.012	PL/J31	5.0	2.5	5.7	2220	20	F125PL123(1)050(2)	SMC5.7123(1)50J31(2)
50	30	0.015	PL/J31	5.0	2.5	5.7	2220	15	F125PL153(1)050(2)	SMC5.7153(1)50J31(2)
50	30	0.018	PL/J31	5.0	2.5	5.7	2220	15	F125PL183(1)050(2)	SMC5.7183(1)50J31(2)
50	30	0.022	PL/J31	5.0	2.5	5.7	2220	15	F125PL223(1)050(2)	SMC5.7223(1)50J31(2)
50	30	0.027	PL/J31	5.0	2.5	5.7	2220	15	F125PL273(1)050(2)	SMC5.7273(1)50J31(2)
50	30	0.033	PL/J31	5.0	2.5	5.7	2220	15	F125PL333(1)050(2)	SMC5.7333(1)50J31(2)
50	30	0.039	PP/J33	5.0	3.0	5.7	2220	6	F125PP393(1)050(2)	SMC5.7393(1)50J33(2)
50	30	0.047	PP/J33	5.0	3.0	5.7	2220	6	F125PP473(1)050(2)	SMC5.7473(1)50J33(2)
50	30	0.056	PU/J35	5.0	4.0	5.7	2220	6	F125PU563(1)050(2)	SMC5.7563(1)50J35(2)
50	30	0.068	PU/J35	5.0	4.0	5.7	2220	6	F125PU683(1)050(2)	SMC5.7683(1)50J35(2)
50	30	0.082	PU/J35	5.0	4.0	5.7	2220	6	F125PU823(1)050(2)	SMC5.7823(1)50J35(2)
50	30	0.10	PU/J35	5.0	4.0	5.7	2220	6	F125PU104(1)050(2)	SMC5.7104(1)50J35(2)
50	30	0.0010	SG/K31	6.0	2.5	7.3	2824	20	F125SG102(1)050(2)	SMC7.3102(1)50K31(2)
50	30	0.0012	SG/K31	6.0	2.5	7.3	2824	20	F125SG122(1)050(2)	SMC7.3122(1)50K31(2)
50	30	0.0015	SG/K31	6.0	2.5	7.3	2824	20	F125SG152(1)050(2)	SMC7.3152(1)50K31(2)
50	30	0.0018	SG/K31	6.0	2.5	7.3	2824	20	F125SG182(1)050(2)	SMC7.3182(1)50K31(2)
50	30	0.0022	SG/K31	6.0	2.5	7.3	2824	20	F125SG222(1)050(2)	SMC7.3222(1)50K31(2)
50	30	0.0027	SG/K31	6.0	2.5	7.3	2824	20	F125SG272(1)050(2)	SMC7.3272(1)50K31(2)
50	30	0.0033	SG/K31	6.0	2.5	7.3	2824	20	F125SG332(1)050(2)	SMC7.3332(1)50K31(2)
50	30	0.0039	SG/K31	6.0	2.5	7.3	2824	20	F125SG392(1)050(2)	SMC7.3392(1)50K31(2)
50	30	0.0047	SG/K31	6.0	2.5	7.3	2824	20	F125SG472(1)050(2)	SMC7.3472(1)50K31(2)
50	30	0.0056	SG/K31	6.0	2.5	7.3	2824	20	F125SG562(1)050(2)	SMC7.3562(1)50K31(2)
50	30	0.0068	SG/K31	6.0	2.5	7.3	2824	20	F125SG682(1)050(2)	SMC7.3682(1)50K31(2)
50	30	0.0082	SG/K31	6.0	2.5	7.3	2824	20	F125SG822(1)050(2)	SMC7.3822(1)50K31(2)
50	30	0.010	SG/K31	6.0	2.5	7.3	2824	20	F125SG103(1)050(2)	SMC7.3103(1)50K31(2)
50	30	0.012	SG/K31	6.0	2.5	7.3	2824	20	F125SG123(1)050(2)	SMC7.3123(1)50K31(2)
50	30	0.015	SG/K31	6.0	2.5	7.3	2824	20	F125SG153(1)050(2)	SMC7.3153(1)50K31(2)
50	30	0.018	SG/K31	6.0	2.5	7.3	2824	20	F125SG183(1)050(2)	SMC7.3183(1)50K31(2)
50	30	0.022	SG/K31	6.0	2.5	7.3	2824	20	F125SG223(1)050(2)	SMC7.3223(1)50K31(2)
50	30	0.027	SG/K31	6.0	2.5	7.3	2824	20	F125SG273(1)050(2)	SMC7.3273(1)50K31(2)
50	30	0.033	SG/K31	6.0	2.5	7.3	2824	15	F125SG333(1)050(2)	SMC7.3333(1)50K31(2)
50	30	0.039	SG/K31	6.0	2.5	7.3	2824	15	F125SG393(1)050(2)	SMC7.3393(1)50K31(2)
50	30	0.047	SG/K31	6.0	2.5	7.3	2824	15	F125SG473(1)050(2)	SMC7.3473(1)50K31(2)
50	30	0.056	SG/K31	6.0	2.5	7.3	2824	15	F125SG563(1)050(2)	SMC7.3563(1)50K31(2)
50	30	0.068	SG/K31	6.0	2.5	7.3	2824	15	F125SG683(1)050(2)	SMC7.3683(1)50K31(2)
50	30	0.082	SL/K33	6.0	3.0	7.3	2824	6	F125SL823(1)050(2)	SMC7.3823(1)50K33(2)
50	30	0.10	SL/K33	6.0	3.0	7.3	2824	6	F125SL104(1)050(2)	SMC7.3104(1)50K33(2)
50	30	0.12	SP/K35	6.0	3.5	7.3	2824	6	F125SP124(1)050(2)	SMC7.3124(1)50K35(2)
50	30	0.15	SP/K35	6.0	3.5	7.3	2824	6	F125SP154(1)050(2)	SMC7.3154(1)50K35(2)
50	30	0.18	SP/K35	6.0	3.5	7.3	2824	6	F125SP184(1)050(2)	SMC7.3184(1)50K35(2)
50	30	0.22	ST/K37	6.0	4.5	7.3	2824	6	F125ST224(1)050(2)	SMC7.3224(1)50K37(2)
50	30	0.010	WP/A31	9.1	5.5	10.2	4036	4	F125WP103(1)050(2)	SMC10.2103(1)50A31(2)
50	30	0.012	WP/A31	9.1	5.5	10.2	4036	4	F125WP123(1)050(2)	SMC10.2123(1)50A31(2)
50	30	0.015	WP/A31	9.1	5.5	10.2	4036	4	F125WP153(1)050(2)	SMC10.2153(1)50A31(2)
50	30	0.018	WP/A31	9.1	5.5	10.2	4036	4	F125WP183(1)050(2)	SMC10.2183(1)50A31(2)
50	30	0.022	WP/A31	9.1	5.5	10.2	4036	4	F125WP223(1)050(2)	SMC10.2223(1)50A31(2)
VDC	VAC	Capacitance Value (µF)	Size Code (New/Legacy)	B (mm)	H (mm)	L (mm)	Chip Size	dV/dt (V/µs)	New KEMET Part Number	Legacy Part Number

(1) G = ±2%, R = ±2.5% (Legacy code = H), J = ±5%.

(2) Insert ordering code for lead type and packaging. See Ordering Options Table for available options.

Table 1 – Ratings & Part Number Reference cont'd

VDC	VAC	Capacitance Value (µF)	Size Code (New/Legacy)	Dimensions in mm			Chip Size	dV/dt (V/µs)	New KEMET Part Number	Legacy Part Number
				B	H	L				
50	30	0.027	WP/A31	9.1	5.5	10.2	4036	4	F125WP273(1)050(2)	SMC10.2273(1)50A31(2)
50	30	0.033	WP/A31	9.1	5.5	10.2	4036	4	F125WP333(1)050(2)	SMC10.2333(1)50A31(2)
50	30	0.039	WP/A31	9.1	5.5	10.2	4036	4	F125WP393(1)050(2)	SMC10.2393(1)50A31(2)
50	30	0.047	WP/A31	9.1	5.5	10.2	4036	4	F125WP473(1)050(2)	SMC10.2473(1)50A31(2)
50	30	0.056	WP/A31	9.1	5.5	10.2	4036	4	F125WP563(1)050(2)	SMC10.2563(1)50A31(2)
50	30	0.068	WP/A31	9.1	5.5	10.2	4036	4	F125WP683(1)050(2)	SMC10.2683(1)50A31(2)
50	30	0.082	WP/A31	9.1	5.5	10.2	4036	4	F125WP823(1)050(2)	SMC10.2823(1)50A31(2)
50	30	0.10	WP/A31	9.1	5.5	10.2	4036	4	F125WP104(1)050(2)	SMC10.2104(1)50A31(2)
50	30	0.12	WP/A31	9.1	5.5	10.2	4036	4	F125WP124(1)050(2)	SMC10.2124(1)50A31(2)
50	30	0.15	WP/A31	9.1	5.5	10.2	4036	4	F125WP154(1)050(2)	SMC10.2154(1)50A31(2)
50	30	0.18	WP/A31	9.1	5.5	10.2	4036	4	F125WP184(1)050(2)	SMC10.2184(1)50A31(2)
50	30	0.22	WP/A31	9.1	5.5	10.2	4036	4	F125WP224(1)050(2)	SMC10.2224(1)50A31(2)
50	30	0.27	WP/A31	9.1	5.5	10.2	4036	4	F125WP274(1)050(2)	SMC10.2274(1)50A31(2)
50	30	0.33	WP/A31	9.1	5.5	10.2	4036	4	F125WP334(1)050(2)	SMC10.2334(1)50A31(2)
50	30	0.39	WP/A31	9.1	5.5	10.2	4036	4	F125WP394(1)050(2)	SMC10.2394(1)50A31(2)
50	30	0.47	WP/A31	9.1	5.5	10.2	4036	4	F125WP474(1)050(2)	SMC10.2474(1)50A31(2)
50	30	0.56	WP/A31	9.1	5.5	10.2	4036	4	F125WP564(1)050(2)	SMC10.2564(1)50A31(2)
50	30	0.68	WP/A31	9.1	5.5	10.2	4036	4	F125WP684(1)050(2)	SMC10.2684(1)50A31(2)
50	30	0.82	WP/A31	9.1	5.5	10.2	4036	4	F125WP824(1)050(2)	SMC10.2824(1)50A31(2)
50	30	1.0	YR/B31	11.5	6.5	12.7	5045	3	F125YR105(1)050(2)	SMC12.7105(1)50B31(2)
50	30	1.2	YR/B31	11.5	6.5	12.7	5045	3	F125YR125(1)050(2)	SMC12.7125(1)50B31(2)
50	30	1.5	YR/B31	11.5	6.5	12.7	5045	3	F125YR155(1)050(2)	SMC12.7155(1)50B31(2)
50	30	1.8	ZS/C31	15.0	7.0	16.5	6560	2	F125ZS185(1)050(2)	SMC16.5185(1)50C31(2)
50	30	2.2	ZS/C31	15.0	7.0	16.5	6560	2	F125ZS225(1)050(2)	SMC16.5225(1)50C31(2)
50	30	2.7	ZS/C31	15.0	7.0	16.5	6560	2	F125ZS275(1)050(2)	SMC16.5275(1)50C31(2)
50	30	3.3	ZS/C31	15.0	7.0	16.5	6560	2	F125ZS335(1)050(2)	SMC16.5335(1)50C31(2)
100	63	0.0010	PL/J31	5.0	2.5	5.7	2220	20	F125PL102(1)100(2)	SMC5.7102(1)100J31(2)
100	63	0.0012	PL/J31	5.0	2.5	5.7	2220	20	F125PL122(1)100(2)	SMC5.7122(1)100J31(2)
100	63	0.0015	PL/J31	5.0	2.5	5.7	2220	20	F125PL152(1)100(2)	SMC5.7152(1)100J31(2)
100	63	0.0018	PL/J31	5.0	2.5	5.7	2220	20	F125PL182(1)100(2)	SMC5.7182(1)100J31(2)
100	63	0.0022	PL/J31	5.0	2.5	5.7	2220	20	F125PL222(1)100(2)	SMC5.7222(1)100J31(2)
100	63	0.0027	PL/J31	5.0	2.5	5.7	2220	20	F125PL272(1)100(2)	SMC5.7272(1)100J31(2)
100	63	0.0033	PL/J31	5.0	2.5	5.7	2220	20	F125PL332(1)100(2)	SMC5.7332(1)100J31(2)
100	63	0.0039	PL/J31	5.0	2.5	5.7	2220	20	F125PL392(1)100(2)	SMC5.7392(1)100J31(2)
100	63	0.0047	PL/J31	5.0	2.5	5.7	2220	20	F125PL472(1)100(2)	SMC5.7472(1)100J31(2)
100	63	0.0056	PL/J31	5.0	2.5	5.7	2220	20	F125PL562(1)100(2)	SMC5.7562(1)100J31(2)
100	63	0.0068	PL/J31	5.0	2.5	5.7	2220	20	F125PL682(1)100(2)	SMC5.7682(1)100J31(2)
100	63	0.0082	PL/J31	5.0	2.5	5.7	2220	20	F125PL822(1)100(2)	SMC5.7822(1)100J31(2)
100	63	0.010	PL/J31	5.0	2.5	5.7	2220	20	F125PL103(1)100(2)	SMC5.7103(1)100J31(2)
100	63	0.012	PL/J31	5.0	2.5	5.7	2220	20	F125PL123(1)100(2)	SMC5.7123(1)100J31(2)
100	63	0.015	PL/J31	5.0	2.5	5.7	2220	15	F125PL153(1)100(2)	SMC5.7153(1)100J31(2)
100	63	0.018	PP/J33	5.0	3.0	5.7	2220	15	F125PP183(1)100(2)	SMC5.7183(1)100J33(2)
100	63	0.022	PP/J33	5.0	3.0	5.7	2220	15	F125PP223(1)100(2)	SMC5.7223(1)100J33(2)
100	63	0.027	PU/J35	5.0	4.0	5.7	2220	15	F125PU273(1)100(2)	SMC5.7273(1)100J35(2)
100	63	0.033	PU/J35	5.0	4.0	5.7	2220	15	F125PU333(1)100(2)	SMC5.7333(1)100J35(2)
100	63	0.0010	SG/K31	6.0	2.5	7.3	2824	20	F125SG102(1)100(2)	SMC7.3102(1)100K31(2)
100	63	0.0012	SG/K31	6.0	2.5	7.3	2824	20	F125SG122(1)100(2)	SMC7.3122(1)100K31(2)
100	63	0.0015	SG/K31	6.0	2.5	7.3	2824	20	F125SG152(1)100(2)	SMC7.3152(1)100K31(2)
100	63	0.0018	SG/K31	6.0	2.5	7.3	2824	20	F125SG182(1)100(2)	SMC7.3182(1)100K31(2)
100	63	0.0022	SG/K31	6.0	2.5	7.3	2824	20	F125SG222(1)100(2)	SMC7.3222(1)100K31(2)
100	63	0.0027	SG/K31	6.0	2.5	7.3	2824	20	F125SG272(1)100(2)	SMC7.3272(1)100K31(2)
100	63	0.0033	SG/K31	6.0	2.5	7.3	2824	20	F125SG332(1)100(2)	SMC7.3332(1)100K31(2)
100	63	0.0039	SG/K31	6.0	2.5	7.3	2824	20	F125SG392(1)100(2)	SMC7.3392(1)100K31(2)
100	63	0.0047	SG/K31	6.0	2.5	7.3	2824	20	F125SG472(1)100(2)	SMC7.3472(1)100K31(2)
100	63	0.0056	SG/K31	6.0	2.5	7.3	2824	20	F125SG562(1)100(2)	SMC7.3562(1)100K31(2)
100	63	0.0068	SG/K31	6.0	2.5	7.3	2824	20	F125SG682(1)100(2)	SMC7.3682(1)100K31(2)
100	63	0.0082	SG/K31	6.0	2.5	7.3	2824	20	F125SG822(1)100(2)	SMC7.3822(1)100K31(2)
100	63	0.010	SG/K31	6.0	2.5	7.3	2824	20	F125SG103(1)100(2)	SMC7.3103(1)100K31(2)
100	63	0.012	SG/K31	6.0	2.5	7.3	2824	20	F125SG123(1)100(2)	SMC7.3123(1)100K31(2)

(1) G = ±2%, R = ±2.5% (Legacy code = H), J = ±5%.

(2) Insert ordering code for lead type and packaging. See Ordering Options Table for available options.

Table 1 – Ratings & Part Number Reference cont'd

VDC	VAC	Capacitance Value (µF)	Size Code (New/Legacy)	Dimensions in mm			Chip Size	dV/dt (V/µs)	New KEMET Part Number	Legacy Part Number
				B	H	L				
100	63	0.015	SG/K31	6.0	2.5	7.3	2824	20	F125SG153(1)100(2)	SMC7.3153(1)100K31(2)
100	63	0.018	SG/K31	6.0	2.5	7.3	2824	20	F125SG183(1)100(2)	SMC7.3183(1)100K31(2)
100	63	0.022	SG/K31	6.0	2.5	7.3	2824	20	F125SG223(1)100(2)	SMC7.3223(1)100K31(2)
100	63	0.027	SL/K33	6.0	3.0	7.3	2824	15	F125SL273(1)100(2)	SMC7.3273(1)100K33(2)
100	63	0.033	SL/K33	6.0	3.0	7.3	2824	15	F125SL333(1)100(2)	SMC7.3333(1)100K33(2)
100	63	0.039	SP/K35	6.0	3.5	7.3	2824	15	F125SP393(1)100(2)	SMC7.3393(1)100K35(2)
100	63	0.047	SP/K35	6.0	3.5	7.3	2824	15	F125SP473(1)100(2)	SMC7.3473(1)100K35(2)
100	63	0.056	ST/K37	6.0	4.5	7.3	2824	15	F125ST563(1)100(2)	SMC7.3563(1)100K37(2)
100	63	0.068	ST/K37	6.0	4.5	7.3	2824	15	F125ST683(1)100(2)	SMC7.3683(1)100K37(2)
100	63	0.010	WPI/A31	9.1	5.5	10.2	4036	6	F125WP103(1)100(2)	SMC10.2103(1)100A31(2)
100	63	0.012	WPI/A31	9.1	5.5	10.2	4036	6	F125WP123(1)100(2)	SMC10.2123(1)100A31(2)
100	63	0.015	WPI/A31	9.1	5.5	10.2	4036	6	F125WP153(1)100(2)	SMC10.2153(1)100A31(2)
100	63	0.018	WPI/A31	9.1	5.5	10.2	4036	6	F125WP183(1)100(2)	SMC10.2183(1)100A31(2)
100	63	0.022	WPI/A31	9.1	5.5	10.2	4036	6	F125WP223(1)100(2)	SMC10.2223(1)100A31(2)
100	63	0.027	WPI/A31	9.1	5.5	10.2	4036	6	F125WP273(1)100(2)	SMC10.2273(1)100A31(2)
100	63	0.033	WPI/A31	9.1	5.5	10.2	4036	6	F125WP333(1)100(2)	SMC10.2333(1)100A31(2)
100	63	0.039	WPI/A31	9.1	5.5	10.2	4036	6	F125WP393(1)100(2)	SMC10.2393(1)100A31(2)
100	63	0.047	WPI/A31	9.1	5.5	10.2	4036	6	F125WP473(1)100(2)	SMC10.2473(1)100A31(2)
100	63	0.056	WPI/A31	9.1	5.5	10.2	4036	6	F125WP563(1)100(2)	SMC10.2563(1)100A31(2)
100	63	0.068	WPI/A31	9.1	5.5	10.2	4036	6	F125WP683(1)100(2)	SMC10.2683(1)100A31(2)
100	63	0.082	WPI/A31	9.1	5.5	10.2	4036	6	F125WP823(1)100(2)	SMC10.2823(1)100A31(2)
100	63	0.10	WPI/A31	9.1	5.5	10.2	4036	6	F125WP104(1)100(2)	SMC10.2104(1)100A31(2)
100	63	0.12	WPI/A31	9.1	5.5	10.2	4036	6	F125WP124(1)100(2)	SMC10.2124(1)100A31(2)
100	63	0.15	WPI/A31	9.1	5.5	10.2	4036	6	F125WP154(1)100(2)	SMC10.2154(1)100A31(2)
100	63	0.18	WPI/A31	9.1	5.5	10.2	4036	6	F125WP184(1)100(2)	SMC10.2184(1)100A31(2)
100	63	0.22	WPI/A31	9.1	5.5	10.2	4036	6	F125WP224(1)100(2)	SMC10.2224(1)100A31(2)
100	63	0.27	WPI/A31	9.1	5.5	10.2	4036	6	F125WP274(1)100(2)	SMC10.2274(1)100A31(2)
100	63	0.33	YR/B31	11.5	6.5	12.7	5045	5	F125YR334(1)100(2)	SMC12.7334(1)100B31(2)
100	63	0.39	YR/B31	11.5	6.5	12.7	5045	5	F125YR394(1)100(2)	SMC12.7394(1)100B31(2)
100	63	0.47	YR/B31	11.5	6.5	12.7	5045	5	F125YR474(1)100(2)	SMC12.7474(1)100B31(2)
100	63	0.56	YR/B31	11.5	6.5	12.7	5045	5	F125YR564(1)100(2)	SMC12.7564(1)100B31(2)
100	63	0.68	ZS/C31	15.0	7.0	16.5	6560	3	F125ZS684(1)100(2)	SMC16.5684(1)100C31(2)
100	63	0.82	ZS/C31	15.0	7.0	16.5	6560	3	F125ZS824(1)100(2)	SMC16.5824(1)100C31(2)
100	63	1.0	ZS/C31	15.0	7.0	16.5	6560	3	F125ZS105(1)100(2)	SMC16.5105(1)100C31(2)
100	63	1.2	ZS/C31	15.0	7.0	16.5	6560	3	F125ZS125(1)100(2)	SMC16.5125(1)100C31(2)
100	63	1.5	ZS/C31	15.0	7.0	16.5	6560	3	F125ZS155(1)100(2)	SMC16.5155(1)100C31(2)
250	160	0.0010	PL/J31	5.0	2.5	5.7	2220	20	F125PL102(1)250(2)	SMC5.7102(1)250J31(2)
250	160	0.0012	PL/J31	5.0	2.5	5.7	2220	20	F125PL122(1)250(2)	SMC5.7122(1)250J31(2)
250	160	0.0015	PL/J31	5.0	2.5	5.7	2220	20	F125PL152(1)250(2)	SMC5.7152(1)250J31(2)
250	160	0.0018	PL/J31	5.0	2.5	5.7	2220	20	F125PL182(1)250(2)	SMC5.7182(1)250J31(2)
250	160	0.0022	PL/J31	5.0	2.5	5.7	2220	20	F125PL222(1)250(2)	SMC5.7222(1)250J31(2)
250	160	0.0027	PL/J31	5.0	2.5	5.7	2220	20	F125PL272(1)250(2)	SMC5.7272(1)250J31(2)
250	160	0.0033	PL/J31	5.0	2.5	5.7	2220	20	F125PL332(1)250(2)	SMC5.7332(1)250J31(2)
250	160	0.0039	PL/J31	5.0	2.5	5.7	2220	20	F125PL392(1)250(2)	SMC5.7392(1)250J31(2)
250	160	0.0047	PL/J31	5.0	2.5	5.7	2220	20	F125PL472(1)250(2)	SMC5.7472(1)250J31(2)
250	160	0.0056	PP/J33	5.0	3.0	5.7	2220	20	F125PP562(1)250(2)	SMC5.7562(1)250J33(2)
250	160	0.0068	PP/J33	5.0	3.0	5.7	2220	20	F125PP682(1)250(2)	SMC5.7682(1)250J33(2)
250	160	0.0082	PU/J35	5.0	4.0	5.7	2220	20	F125PU822(1)250(2)	SMC5.7822(1)250J35(2)
250	160	0.010	PU/J35	5.0	4.0	5.7	2220	20	F125PU103(1)250(2)	SMC5.7103(1)250J35(2)
250	160	0.0010	SG/K31	6.0	2.5	7.3	2824	20	F125SG102(1)250(2)	SMC7.3102(1)250K31(2)
250	160	0.0012	SG/K31	6.0	2.5	7.3	2824	20	F125SG122(1)250(2)	SMC7.3122(1)250K31(2)
250	160	0.0015	SG/K31	6.0	2.5	7.3	2824	20	F125SG152(1)250(2)	SMC7.3152(1)250K31(2)
250	160	0.0018	SG/K31	6.0	2.5	7.3	2824	20	F125SG182(1)250(2)	SMC7.3182(1)250K31(2)
250	160	0.0022	SG/K31	6.0	2.5	7.3	2824	20	F125SG222(1)250(2)	SMC7.3222(1)250K31(2)
250	160	0.0027	SG/K31	6.0	2.5	7.3	2824	20	F125SG272(1)250(2)	SMC7.3272(1)250K31(2)
250	160	0.0033	SG/K31	6.0	2.5	7.3	2824	20	F125SG332(1)250(2)	SMC7.3332(1)250K31(2)
250	160	0.0039	SG/K31	6.0	2.5	7.3	2824	20	F125SG392(1)250(2)	SMC7.3392(1)250K31(2)
250	160	0.0047	SG/K31	6.0	2.5	7.3	2824	20	F125SG472(1)250(2)	SMC7.3472(1)250K31(2)
250	160	0.0056	SG/K31	6.0	2.5	7.3	2824	20	F125SG562(1)250(2)	SMC7.3562(1)250K31(2)
VDC	VAC	Capacitance Value (µF)	Size Code (New/Legacy)	B (mm)	H (mm)	L (mm)	Chip Size	dV/dt (V/µs)	New KEMET Part Number	Legacy Part Number

(1) G = ±2%, R = ±2.5% (Legacy code = H), J = ±5%.

(2) Insert ordering code for lead type and packaging. See Ordering Options Table for available options.

Table 1 – Ratings & Part Number Reference cont'd

VDC	VAC	Capacitance Value (µF)	Size Code (New/Legacy)	Dimensions in mm			Chip Size	dV/dt (V/µs)	New KEMET Part Number	Legacy Part Number
				B	H	L				
250	160	0.0068	SG/K31	6.0	2.5	7.3	2824	20	F125SG682(1)250(2)	SMC7.3682(1)250K31(2)
250	160	0.0082	SG/K31	6.0	2.5	7.3	2824	20	F125SG822(1)250(2)	SMC7.3822(1)250K31(2)
250	160	0.010	SL/K33	6.0	3.0	7.3	2824	20	F125SL103(1)250(2)	SMC7.3103(1)250K33(2)
250	160	0.012	SL/K33	6.0	3.0	7.3	2824	20	F125SL123(1)250(2)	SMC7.3123(1)250K33(2)
250	160	0.015	SL/K33	6.0	3.0	7.3	2824	20	F125SL153(1)250(2)	SMC7.3153(1)250K33(2)
250	160	0.018	SP/K35	6.0	3.5	7.3	2824	20	F125SP183(1)250(2)	SMC7.3183(1)250K35(2)
250	160	0.022	SP/K35	6.0	3.5	7.3	2824	20	F125SP223(1)250(2)	SMC7.3223(1)250K35(2)
250	160	0.010	WPI/A31	9.1	5.5	10.2	4036	10	F125WP103(1)250(2)	SMC10.2103(1)250A31(2)
250	160	0.012	WPI/A31	9.1	5.5	10.2	4036	10	F125WP123(1)250(2)	SMC10.2123(1)250A31(2)
250	160	0.015	WPI/A31	9.1	5.5	10.2	4036	10	F125WP153(1)250(2)	SMC10.2153(1)250A31(2)
250	160	0.018	WPI/A31	9.1	5.5	10.2	4036	10	F125WP183(1)250(2)	SMC10.2183(1)250A31(2)
250	160	0.022	WPI/A31	9.1	5.5	10.2	4036	10	F125WP223(1)250(2)	SMC10.2223(1)250A31(2)
250	160	0.027	WPI/A31	9.1	5.5	10.2	4036	10	F125WP273(1)250(2)	SMC10.2273(1)250A31(2)
250	160	0.033	WPI/A31	9.1	5.5	10.2	4036	10	F125WP333(1)250(2)	SMC10.2333(1)250A31(2)
250	160	0.039	WPI/A31	9.1	5.5	10.2	4036	10	F125WP393(1)250(2)	SMC10.2393(1)250A31(2)
250	160	0.047	WPI/A31	9.1	5.5	10.2	4036	10	F125WP473(1)250(2)	SMC10.2473(1)250A31(2)
250	160	0.056	WPI/A31	9.1	5.5	10.2	4036	10	F125WP563(1)250(2)	SMC10.2563(1)250A31(2)
250	160	0.068	WPI/A31	9.1	5.5	10.2	4036	10	F125WP683(1)250(2)	SMC10.2683(1)250A31(2)
250	160	0.082	WPI/A31	9.1	5.5	10.2	4036	10	F125WP823(1)250(2)	SMC10.2823(1)250A31(2)
250	160	0.10	WPI/A31	9.1	5.5	10.2	4036	10	F125WP104(1)250(2)	SMC10.2104(1)250A31(2)
250	160	0.12	YR/B31	11.5	6.5	12.7	5045	8	F125YR124(1)250(2)	SMC12.7124(1)250B31(2)
250	160	0.15	YR/B31	11.5	6.5	12.7	5045	8	F125YR154(1)250(2)	SMC12.7154(1)250B31(2)
250	160	0.18	YR/B31	11.5	6.5	12.7	5045	8	F125YR184(1)250(2)	SMC12.7184(1)250B31(2)
250	160	0.22	ZS/C31	15.0	7.0	16.5	6560	5	F125ZS224(1)250(2)	SMC16.5224(1)250C31(2)
250	160	0.27	ZS/C31	15.0	7.0	16.5	6560	5	F125ZS274(1)250(2)	SMC16.5274(1)250C31(2)
250	160	0.33	ZS/C31	15.0	7.0	16.5	6560	5	F125ZS334(1)250(2)	SMC16.5334(1)250C31(2)
250	160	0.39	ZS/C31	15.0	7.0	16.5	6560	5	F125ZS394(1)250(2)	SMC16.5394(1)250C31(2)
250	160	0.47	ZS/C31	15.0	7.0	16.5	6560	5	F125ZS474(1)250(2)	SMC16.5474(1)250C31(2)
400	200	0.0010	PL/J31	5.0	2.5	5.7	2220	40	F125PL102(1)400(2)	SMC5.7102(1)400J31(2)
400	200	0.0012	PL/J31	5.0	2.5	5.7	2220	40	F125PL122(1)400(2)	SMC5.7122(1)400J31(2)
400	200	0.0015	PL/J31	5.0	2.5	5.7	2220	40	F125PL152(1)400(2)	SMC5.7152(1)400J31(2)
400	200	0.0018	PP/J33	5.0	3.0	5.7	2220	40	F125PP182(1)400(2)	SMC5.7182(1)400J33(2)
400	200	0.0022	PP/J33	5.0	3.0	5.7	2220	40	F125PP222(1)400(2)	SMC5.7222(1)400J33(2)
400	200	0.0027	PU/J35	5.0	4.0	5.7	2220	40	F125PU272(1)400(2)	SMC5.7272(1)400J35(2)
400	200	0.0033	PU/J35	5.0	4.0	5.7	2220	40	F125PU332(1)400(2)	SMC5.7332(1)400J35(2)
400	200	0.0010	SG/K31	6.0	2.5	7.3	2824	25	F125SG102(1)400(2)	SMC7.3102(1)400K31(2)
400	200	0.0012	SG/K31	6.0	2.5	7.3	2824	25	F125SG122(1)400(2)	SMC7.3122(1)400K31(2)
400	200	0.0015	SG/K31	6.0	2.5	7.3	2824	25	F125SG152(1)400(2)	SMC7.3152(1)400K31(2)
400	200	0.0018	SG/K31	6.0	2.5	7.3	2824	25	F125SG182(1)400(2)	SMC7.3182(1)400K31(2)
400	200	0.0022	SG/K31	6.0	2.5	7.3	2824	25	F125SG222(1)400(2)	SMC7.3222(1)400K31(2)
400	200	0.0027	SG/K31	6.0	2.5	7.3	2824	25	F125SG272(1)400(2)	SMC7.3272(1)400K31(2)
400	200	0.0033	SL/K33	6.0	3.0	7.3	2824	25	F125SL332(1)400(2)	SMC7.3332(1)400K33(2)
400	200	0.0039	SL/K33	6.0	3.0	7.3	2824	25	F125SL392(1)400(2)	SMC7.3392(1)400K33(2)
400	200	0.0047	SL/K33	6.0	3.0	7.3	2824	25	F125SL472(1)400(2)	SMC7.3472(1)400K33(2)
400	200	0.0056	SP/K35	6.0	3.5	7.3	2824	25	F125SP562(1)400(2)	SMC7.3562(1)400K35(2)
400	200	0.0068	SP/K35	6.0	3.5	7.3	2824	25	F125SP682(1)400(2)	SMC7.3682(1)400K35(2)
400	200	0.0082	ST/K37	6.0	4.5	7.3	2824	25	F125ST822(1)400(2)	SMC7.3822(1)400K37(2)
400	200	0.010	ST/K37	6.0	4.5	7.3	2824	25	F125ST103(1)400(2)	SMC7.3103(1)400K37(2)
400	200	0.010	WPI/A31	9.1	5.5	10.2	4036	15	F125WP103(1)400(2)	SMC10.2103(1)400A31(2)
400	200	0.012	WPI/A31	9.1	5.5	10.2	4036	15	F125WP123(1)400(2)	SMC10.2123(1)400A31(2)
400	200	0.015	WPI/A31	9.1	5.5	10.2	4036	15	F125WP153(1)400(2)	SMC10.2153(1)400A31(2)
400	200	0.018	WPI/A31	9.1	5.5	10.2	4036	15	F125WP183(1)400(2)	SMC10.2183(1)400A31(2)
400	200	0.022	WPI/A31	9.1	5.5	10.2	4036	15	F125WP223(1)400(2)	SMC10.2223(1)400A31(2)
400	200	0.027	WPI/A31	9.1	5.5	10.2	4036	15	F125WP273(1)400(2)	SMC10.2273(1)400A31(2)
400	200	0.033	WPI/A31	9.1	5.5	10.2	4036	15	F125WP333(1)400(2)	SMC10.2333(1)400A31(2)
400	200	0.039	WPI/A31	9.1	5.5	10.2	4036	15	F125WP393(1)400(2)	SMC10.2393(1)400A31(2)
400	200	0.047	YR/B31	11.5	6.5	12.7	5045	10	F125YR473(1)400(2)	SMC12.7473(1)400B31(2)
400	200	0.056	YR/B31	11.5	6.5	12.7	5045	10	F125YR563(1)400(2)	SMC12.7563(1)400B31(2)
400	200	0.068	YR/B31	11.5	6.5	12.7	5045	10	F125YR683(1)400(2)	SMC12.7683(1)400B31(2)

(1) G = ±2%, R = ±2.5% (Legacy code = H), J = ±5%.

(2) Insert ordering code for lead type and packaging. See Ordering Options Table for available options.

Table 1 – Ratings & Part Number Reference cont'd

VDC	VAC	Capacitance Value (µF)	Size Code (New/Legacy)	Dimensions in mm			Chip Size	dV/dt (V/µs)	New KEMET Part Number	Legacy Part Number
				B	H	L				
400	200	0.082	YR/B31	11.5	6.5	12.7	5045	10	F125YR823(1)400(2)	SMC12.7823(1)400B31(2)
400	200	0.10	ZS/C31	15.0	7.0	16.5	6560	8	F125ZS104(1)400(2)	SMC16.5104(1)400C31(2)
400	200	0.12	ZS/C31	15.0	7.0	16.5	6560	8	F125ZS124(1)400(2)	SMC16.5124(1)400C31(2)
400	200	0.15	ZS/C31	15.0	7.0	16.5	6560	8	F125ZS154(1)400(2)	SMC16.5154(1)400C31(2)
400	200	0.18	ZS/C31	15.0	7.0	16.5	6560	8	F125ZS184(1)400(2)	SMC16.5184(1)400C31(2)
400	200	0.22	ZS/C31	15.0	7.0	16.5	6560	8	F125ZS224(1)400(2)	SMC16.5224(1)400C31(2)
VDC	VAC	Capacitance Value (µF)	Size Code (New/Legacy)	B (mm)	H (mm)	L (mm)	Chip Size	dV/dt (V/µs)	New KEMET Part Number	Legacy Part Number

(1) G = ±2%, R = ±2.5% (Legacy code = H), J = ±5%.

(2) Insert ordering code for lead type and packaging. See Ordering Options Table for available options.

Soldering Process

Reflow soldering temperature is measured on the top surface of the component: Preheating temperature should be less than 170°C. The time above 217°C should be less than 50 seconds. The peak temperature must not exceed 260°C.

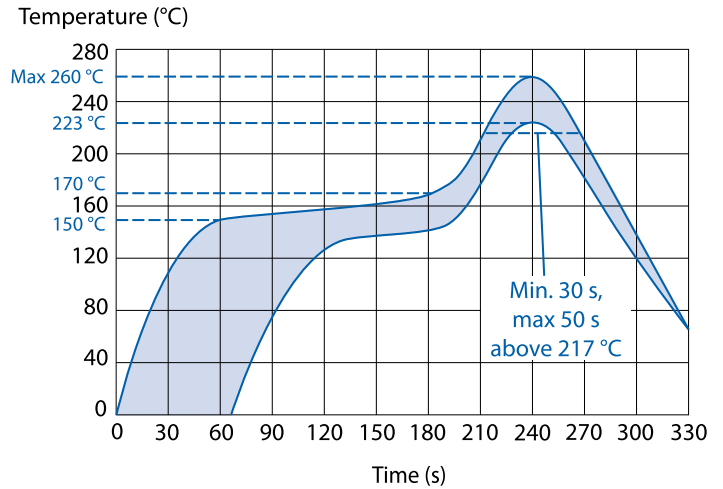

Marking

- Capacitance
- Capacitance tolerance code
- Rated voltage code
- Capacitor type S for SMC
- Manufacturing date code

Rated Voltage	Code
50 VDC	Z
100 VDC	D
250 VDC	H
400 VDC	K

Manufacturing Date Code (IEC 60062)			
Y = Year, Z = Month			
Year	Code	Month	Code
2000	M	January	1
2001	N	February	2
2002	P	March	3
2003	R	April	4
2004	S	May	5
2005	T	June	6
2006	U	July	7
2007	V	August	8
2008	W	September	9
2009	X	October	O
2010	A	November	N
2011	B	December	D
2012	C		
2013	D		
2014	E		
2015	F		
2016	H		
2017	J		
2018	K		
2019	L		
2020	M		

Storage and Moisture Recommendations

KEMET SMD Film Capacitors are supplied in a MBB (Moisture Barrier Bag) Class 1. We can guarantee a 24 months shelf life (temperature $\leq 40^{\circ}\text{C}$ /relative humidity $\leq 90\%$). After the MBB has been opened, components may stay in areas with controlled temperature and humidity (temperature $\leq 30^{\circ}\text{C}$ /relative humidity $\leq 60\%$) for 696 hours [MSL 2a]. For longer periods of time and/or higher temperature and/or higher relative humidity values, it is absolutely necessary to protect the components against humidity. If the reel inside the MBB is partially used, KEMET recommends to re-use the same MBB or to avoid areas without controlled temperature and humidity (see above). If the above conditions are not respected, components require a baking (minimum time: 48 hours at $55 \pm 5^{\circ}\text{C}$) before the reflow.

Packaging Quantities

Chip Size (EIA)	Base (mm)	Height (mm)	Length (mm)	Bulk	Reel Horizontal Orientation	Reel Vertical Orientation
2220	5	2.5	5.7	2000	3100	
2220	5	3	5.7	2000	2400	
2220	5	4	5.7	2000	2100	
2824	6	2.5	7.3	2000	3100	
2824	6	3	7.3	2000	2500	
2824	6	3.5	7.3	2000	2300	
2824	6	4.5	7.3	1000	1700	
4036	9.1	5.5	10.2	1000	800	500
5045	11.5	6.5	12.7	1000	600	400
6560	15	7	16.5	800	500	200

Landing

Mounting	Chip Size	Dimensions in mm		
		A	B	X
Horizontal	2220	5.1	1.5	3.0
	2824	6.1	1.5	3.8
	4036	9.1	2.0	5.5
	5045	11.6	2.5	7.0
	6560	15.0	3.0	9.0
Vertical	4022	5.6	2.0	5.5
	5026	6.6	2.5	7.0
	6528	7.1	3.0	9.0

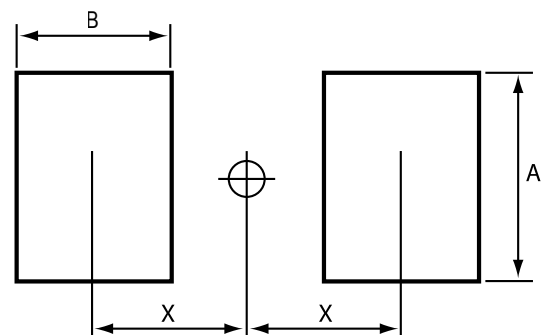

Carrier Taping & Packaging (IEC 60286–2)

Horizontal Taping Orientation

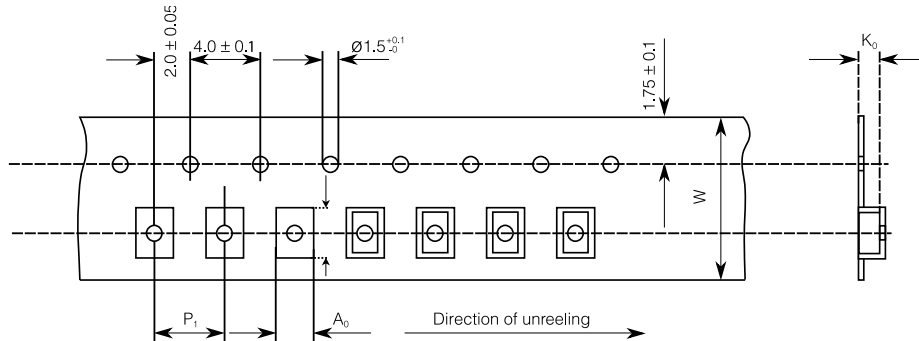

Chip Size (EIA) Horizontal Mounting	Dimensions in mm			Taping Specification							
	B	H	L	W	P ₁	A ₀	B ₀	K ₀	D	W ₁	W ₂
	Nominal	Nominal	Nominal	-0/+0.3	+/-0.1	Nominal	Nominal	Nominal	-/+2.0	-0/+2	Maximum
2220	5.0	2.5	5.7	12.0	8.0	5.5	6.0	2.8	330	12.4	22.0
2220	5.0	3.0	5.7	12.0	8.0	5.5	6.0	3.3	330	12.4	22.0
2220	5.0	4.0	5.7	12.0	8.0	5.5	6.0	4.3	330	12.4	22.0
2824	6.0	2.5	7.3	12.0	8.0	6.5	7.5	2.8	330	12.4	22.0
2824	6.0	3.0	7.3	12.0	8.0	6.5	7.5	3.3	330	12.4	22.0
2824	6.0	3.5	7.3	12.0	8.0	6.5	7.5	3.8	330	12.4	22.0
2824	6.0	4.5	7.3	16.0	8.0	6.6	7.9	5.5	330	16.0	20.0
4036	9.1	5.5	10.2	16.0	16.0	9.5	10.5	5.8	330	16.4	22.0
5045	11.5	6.5	12.7	24.0	16.0	11.9	13.1	6.8	330	24.4	30.0
6560	15.0	7.0	16.5	24.0	20.0	15.4	16.8	7.3	330	24.4	30.0

Carrier Taping & Packaging (IEC 60286–2) cont'd

Vertical Taping Orientation

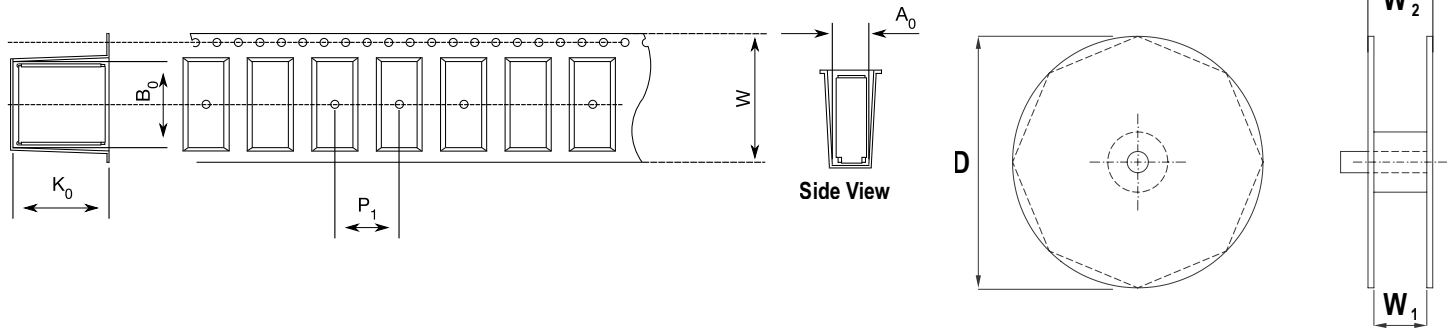

Size Code Vertical Mounting	Dimensions in mm			Taping Specification							
	B	H	L	W	P ₁	A ₀	B ₀	K ₀	D	W ₁	W ₂
	Nominal	Nominal	Nominal	-0/+0.3	+/-0.1	Nominal	Nominal	Nominal	-/+2.0	-0/+2	Maximum
4022	5.5	9.1	10.2	24.0	16.0	6.0	10.5	9.3	330	24.4	30.0
5026	6.5	11.5	12.7	24.0	16.0	6.9	13.1	11.8	330	24.4	30.0
6528	7.0	15.0	16.5	44.0	20.0	7.5	17.0	15.3	330	44.5	49.5

Note: Chip dimensions B and H correspond to dimensions H and B in the horizontal mounting table.

KEMET Corporation World Headquarters

2835 KEMET Way
Simpsonville, SC 29681

Mailing Address:
P.O. Box 5928
Greenville, SC 29606

www.kemet.com
Tel: 864-963-6300
Fax: 864-963-6521

Corporate Offices
Fort Lauderdale, FL
Tel: 954-766-2800

North America

Southeast

Lake Mary, FL
Tel: 407-855-8886

Northeast

Wilmington, MA
Tel: 978-658-1663

Central

Novi, MI
Tel: 248-994-1030

West

Milpitas, CA
Tel: 408-433-9950

Mexico

Guadalajara, Jalisco
Tel: 52-33-3123-2141

Europe

Southern Europe

Sasso Marconi, Italy
Tel: 39-051-939111

Skopje, Macedonia
Tel: 389-2-55-14-623

Central Europe

Landsberg, Germany
Tel: 49-8191-3350800

Kamen, Germany
Tel: 49-2307-438110

Northern Europe

Wyboston, United Kingdom
Tel: 44-1480-273082

Espoo, Finland
Tel: 358-9-5406-5000

Asia

Northeast Asia

Hong Kong
Tel: 852-2305-1168

Shenzhen, China
Tel: 86-755-2518-1306

Beijing, China
Tel: 86-10-5877-1075

Shanghai, China
Tel: 86-21-6447-0707

Seoul, South Korea
Tel: 82-2-6294-0550

Taipei, Taiwan
Tel: 886-2-27528585

Southeast Asia

Singapore
Tel: 65-6701-8033

Penang, Malaysia
Tel: 60-4-6430200

Bangalore, India
Tel: 91-806-53-76817

Note: KEMET reserves the right to modify minor details of internal and external construction at any time in the interest of product improvement. KEMET does not assume any responsibility for infringement that might result from the use of KEMET Capacitors in potential circuit designs. KEMET is a registered trademark of KEMET Electronics Corporation.

Disclaimer

All product specifications, statements, information and data (collectively, the "Information") in this datasheet are subject to change. The customer is responsible for checking and verifying the extent to which the Information contained in this publication is applicable to an order at the time the order is placed.

All Information given herein is believed to be accurate and reliable, but it is presented without guarantee, warranty, or responsibility of any kind, expressed or implied.

Statements of suitability for certain applications are based on KEMET Electronics Corporation's ("KEMET") knowledge of typical operating conditions for such applications, but are not intended to constitute – and KEMET specifically disclaims – any warranty concerning suitability for a specific customer application or use. The Information is intended for use only by customers who have the requisite experience and capability to determine the correct products for their application. Any technical advice inferred from this Information or otherwise provided by KEMET with reference to the use of KEMET's products is given gratis, and KEMET assumes no obligation or liability for the advice given or results obtained.

Although KEMET designs and manufactures its products to the most stringent quality and safety standards, given the current state of the art, isolated component failures may still occur. Accordingly, customer applications which require a high degree of reliability or safety should employ suitable designs or other safeguards (such as installation of protective circuitry or redundancies) in order to ensure that the failure of an electrical component does not result in a risk of personal injury or property damage.

Although all product-related warnings, cautions and notes must be observed, the customer should not assume that all safety measures are indicated or that other measures may not be required.