

MC74HC589A

8-Bit Serial or Parallel-Input/Serial-Output Shift Register with 3-State Output

High-Performance Silicon-Gate CMOS

The MC74HC589A device consists of an 8-bit storage latch which feeds parallel data to an 8-bit shift register. Data can also be loaded serially (see the Function Table). The shift register output, Q_H , is a 3-state output, allowing this device to be used in bus-oriented systems.

The HC589A directly interfaces with the SPI serial data port on CMOS MPUs and MCUs.

Features

- Output Drive Capability: 15 LSTTL Loads
- Outputs Directly Interface to CMOS, NMOS, and TTL
- Operating Voltage Range: 2.0 to 6.0 V
- Low Input Current: 1 μ A
- High Noise Immunity Characteristic of CMOS Devices
- In Compliance with the Requirements Defined by JEDEC Standard No. 7A
- Chip Complexity: 526 FETs or 131.5 Equivalent Gates
- Pb-Free Packages are Available



ON Semiconductor®

<http://onsemi.com>

MARKING DIAGRAMS

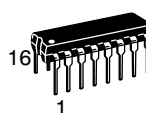

PDIP-16
N SUFFIX
CASE 648

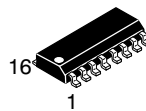
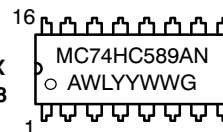

SOIC-16
D SUFFIX
CASE 751B

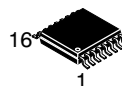
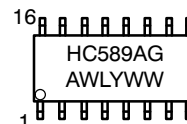

TSSOP-16
DT SUFFIX
CASE 948F

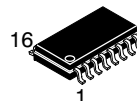
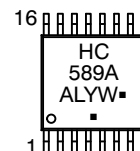

SOEIAJ-16
F SUFFIX
CASE 966

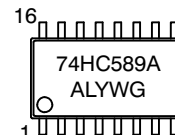

A = Assembly Location
WL, L = Wafer Lot
YY, Y = Year
WW, W = Work Week
G = Pb-Free Package
▪ = Pb-Free Package

(Note: Microdot may be in either location)

ORDERING INFORMATION

See detailed ordering and shipping information in the package dimensions section on page 2 of this data sheet.

MC74HC589A

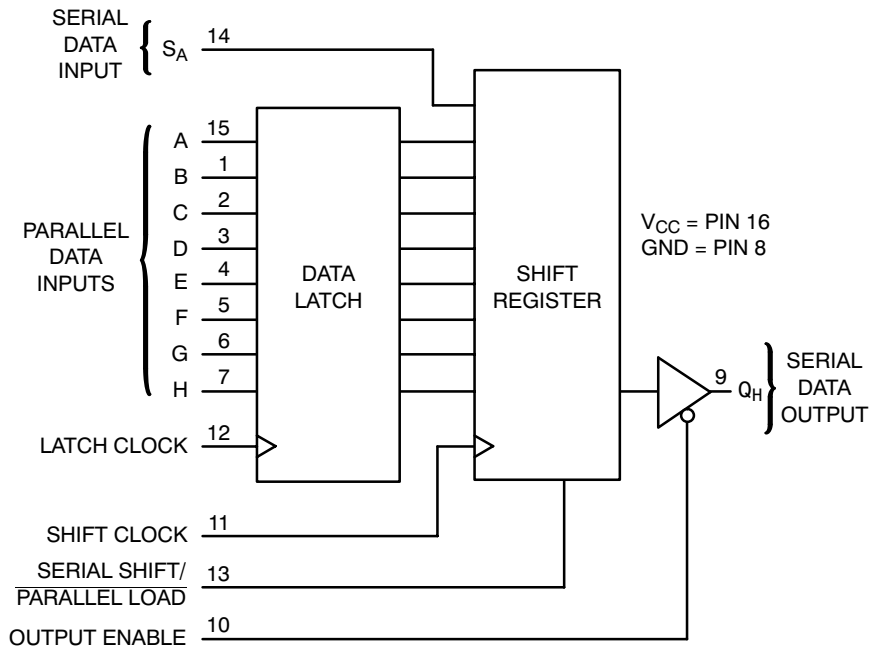

Figure 1. Logic Diagram

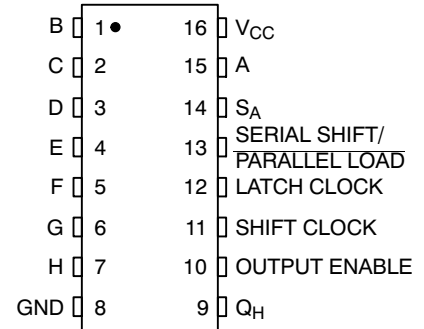

Figure 2. Pin Assignment

ORDERING INFORMATION

| Device | Package | Shipping† |
|-----------------|------------------------|------------------|
| MC74HC589AN | PDIP-16 | 25 Units / Rail |
| MC74HC589ANG | PDIP-16 (Pb-Free) | 25 Units / Rail |
| MC74HC589AD | SOIC-16 | 48 Units / Rail |
| MC74HC589ADG | SOIC-16 (Pb-Free) | 48 Units / Rail |
| MC74HC589ADR2 | SOIC-16 | 2500 Tape & Reel |
| MC74HC589ADR2G | SOIC-16 (Pb-Free) | 2500 Tape & Reel |
| MC74HC589ADTR2 | TSSOP-16* | 2500 Tape & Reel |
| MC74HC589ADTR2G | TSSOP-16* | 2500 Tape & Reel |
| MC74HC589AFELG | SOEIAJ-16 (Pb-Free) | 2000 Tape & Reel |

†For information on tape and reel specifications, including part orientation and tape sizes, please refer to our Tape and Reel Packaging Specifications Brochure, BRD8011/D.

*This package is inherently Pb-Free.

MC74HC589A

MAXIMUM RATINGS

| Symbol | Parameter | Value | Unit |
|----------------------|---|--|----------|
| V _{CC} | DC Supply Voltage (Referenced to GND) | - 0.5 to +7.0 | V |
| V _{in} | DC Input Voltage (Referenced to GND) | - 0.5 ≤ V _{CC} + 0.5 | V |
| V _{out} | DC Output Voltage (Referenced to GND) | - 0.5 ≤ V _{CC} + 0.5 | V |
| I _{in} | DC Input Current, per Pin | ± 20 | mA |
| I _{out} | DC Output Current, per Pin | ± 35 | mA |
| I _{CC} | DC Supply Current, V _{CC} and GND Pins | ± 75 | mA |
| I _{GND} | DC Ground Current per Ground Pin | ± 75 | mA |
| T _{STG} | Storage Temperature Range | - 65 to + 150 | °C |
| T _L | Lead Temperature, 1 mm from Case for 10 Seconds | 260 | °C |
| T _J | Junction Temperature Under Bias | + 150 | °C |
| θ _{JA} | Thermal Resistance | PDIP 78 SOIC 112 TSSOP 148 | °C/W |
| P _D | Power Dissipation in Still Air at 85°C | PDIP 750 SOIC 500 TSSOP 450 | mW |
| MSL | Moisture Sensitivity | Level 1 | |
| F _R | Flammability Rating | Oxygen Index: 30% - 35% UL 94 V-0 @ 0.125 in | |
| V _{ESD} | ESD Withstand Voltage | Human Body Model (Note 1) > 4000 Machine Model (Note 2) > 200 Charged Device Model (Note 3) > 1000 | V |
| I _{Latchup} | Latchup Performance | Above V _{CC} and Below GND at 85°C (Note 4) | ± 300 mA |

Stresses exceeding Maximum Ratings may damage the device. Maximum Ratings are stress ratings only. Functional operation above the Recommended Operating Conditions is not implied. Extended exposure to stresses above the Recommended Operating Conditions may affect device reliability.

1. Tested to EIA/JESD22-A114-A.
2. Tested to EIA/JESD22-A115-A.
3. Tested to JESD22-C101-A.
4. Tested to EIA/JESD78.
5. For high frequency or heavy load considerations, see the ON Semiconductor High-Speed CMOS Data Book (DL129/D).

RECOMMENDED OPERATING CONDITIONS

| Symbol | Parameter | Min | Max | Unit |
|---------------------------------------|--|--|---------------------------|------|
| V _{CC} | DC Supply Voltage (Referenced to GND) | 2.0 | 6.0 | V |
| V _{in} , V _{out} | DC Input Voltage, Output Voltage (Referenced to GND) | 0 | V _{CC} | V |
| T _A | Operating Temperature, All Package Types | - 55 | + 125 | °C |
| t _r , t _f | Input Rise and Fall Time (Figure 3) | V _{CC} = 2.0 V 0 V _{CC} = 3.0 V 0 V _{CC} = 4.5 V 0 V _{CC} = 6.0 V 0 | 1000 800 500 400 | ns |

6. Unused inputs may not be left open. All inputs must be tied to a high-logic voltage level or a low-logic input voltage level.

MC74HC589A

DC ELECTRICAL CHARACTERISTICS (Voltages Referenced to GND, Note 7)

| Symbol | Parameter | Test Conditions | V _{CC} V | Guaranteed Limit | | | Unit |
|-----------------|--|--|----------------------|------------------|--------|---------|------|
| | | | | -55°C to 25°C | ≤ 85°C | ≤ 125°C | |
| V _{IH} | Minimum High-Level Input Voltage | V _{out} = 0.1 V or V _{CC} - 0.1 V I _{out} ≤ 20 μA | 2.0 | 1.5 | 1.5 | 1.5 | V |
| | | | 3.0 | 2.1 | 2.1 | 2.1 | |
| | | | 4.5 | 3.15 | 3.15 | 3.15 | |
| | | | 6.0 | 4.2 | 4.2 | 4.2 | |
| V _{IL} | Maximum Low-Level Input Voltage | V _{out} = 0.1 V or V _{CC} - 0.1 V I _{out} ≤ 20 μA | 2.0 | 0.5 | 0.5 | 0.5 | V |
| | | | 3.0 | 0.9 | 0.9 | 0.9 | |
| | | | 4.5 | 1.35 | 1.35 | 1.35 | |
| | | | 6.0 | 1.8 | 1.8 | 1.8 | |
| V _{OH} | Minimum High-Level Output Voltage | V _{in} = V _{IH} or V _{IL} I _{out} ≤ 20 μA | 2.0 | 1.9 | 1.9 | 1.9 | V |
| | | | 4.5 | 4.4 | 4.4 | 4.4 | |
| | | | 6.0 | 5.9 | 5.9 | 5.9 | |
| | | V _{in} = V _{IH} or V _{IL} I _{out} ≤ 2.4 mA I _{out} ≤ 6.0 mA I _{out} ≤ 7.8 mA | 3.0 | 2.48 | 2.34 | 2.20 | |
| | | | 4.5 | 3.98 | 3.84 | 3.70 | |
| | | | 6.0 | 5.48 | 5.34 | 5.20 | |
| V _{OL} | Maximum Low-Level Output Voltage | V _{in} = V _{IH} I _{out} ≤ 20 μA | 2.0 | 0.1 | 0.1 | 0.1 | V |
| | | | 4.5 | 0.1 | 0.1 | 0.1 | |
| | | | 6.0 | 0.1 | 0.1 | 0.1 | |
| | | V _{in} = V _{IH} or V _{IL} I _{out} ≤ 2.4 mA I _{out} ≤ 6.0 mA I _{out} ≤ 7.8 mA | 3.0 | 0.26 | 0.33 | 0.40 | |
| | | | 4.5 | 0.26 | 0.33 | 0.40 | |
| | | | 6.0 | 0.26 | 0.33 | 0.40 | |
| I _{in} | Maximum Input Leakage Current | V _{in} = V _{CC} or GND | 6.0 | ± 0.1 | ± 1.0 | ± 1.0 | μA |
| I _{OZ} | Maximum Three-State Leakage Current | Output in High-Impedance State V _{in} = V _{IL} or V _{IH} V _{out} = V _{CC} or GND | 6.0 | ± 0.5 | ± 5.0 | ± 10 | μA |
| I _{CC} | Maximum Quiescent Supply Current (per Package) | V _{in} = V _{CC} or GND I _{out} = 0 μA | 6.0 | 4 | 40 | 160 | μA |

7. Information on typical parametric values can be found in the ON Semiconductor High-Speed CMOS Data Book (DL129/D).

MC74HC589A

AC ELECTRICAL CHARACTERISTICS (C_L = 50 pF, Input t_r = t_f = 6 ns, Notes 8 and 9)

| Symbol | Parameter | V _{CC} V | Guaranteed Limit | | | Unit |
|--|---|----------------------|------------------|--------|---------|------|
| | | | -55°C to 25°C | ≤ 85°C | ≤ 125°C | |
| f _{max} | Maximum Clock Frequency (50% Duty Cycle) (Figures 4 and 10) | 2.0 | 6.0 | 4.8 | 4.0 | MHz |
| | | 3.0 | 15 | 10 | 8.0 | |
| | | 4.5 | 30 | 24 | 20 | |
| | | 6.0 | 35 | 28 | 24 | |
| t _{PLH} , t _{PHL} | Maximum Propagation Delay, Latch Clock to Q _H (Figures 3 and 10) | 2.0 | 175 | 225 | 275 | ns |
| | | 3.0 | 100 | 110 | 125 | |
| | | 4.5 | 40 | 50 | 60 | |
| | | 6.0 | 30 | 40 | 50 | |
| t _{PLH} , t _{PHL} | Maximum Propagation Delay, Shift Clock to Q _H (Figures 4 and 10) | 2.0 | 160 | 200 | 240 | ns |
| | | 3.0 | 90 | 130 | 160 | |
| | | 4.5 | 30 | 40 | 48 | |
| | | 6.0 | 25 | 30 | 40 | |
| t _{PLH} , t _{PHL} | Maximum Propagation Delay, Serial Shift/Parallel Load to Q _H (Figures 6 and 10) | 2.0 | 160 | 200 | 240 | ns |
| | | 3.0 | 90 | 130 | 160 | |
| | | 4.5 | 30 | 40 | 48 | |
| | | 6.0 | 25 | 30 | 40 | |
| t _{PLZ} , t _{PHZ} | Maximum Propagation Delay, Output Enable to Q _H (Figures 5 and 11) | 2.0 | 150 | 170 | 200 | ns |
| | | 3.0 | 80 | 100 | 130 | |
| | | 4.5 | 27 | 30 | 40 | |
| | | 6.0 | 23 | 25 | 30 | |
| t _{PZL} , t _{PZH} | Maximum Propagation Delay, Output Enable to Q _H (Figures 5 and 11) | 2.0 | 150 | 170 | 200 | ns |
| | | 3.0 | 80 | 100 | 130 | |
| | | 4.5 | 27 | 30 | 40 | |
| | | 6.0 | 23 | 25 | 30 | |
| t _{TLH} , t _{THL} | Maximum Output Transition Time, Any Output (Figures 3 and 10) | 2.0 | 60 | 75 | 90 | ns |
| | | 3.0 | 23 | 27 | 31 | |
| | | 4.5 | 12 | 15 | 18 | |
| | | 6.0 | 10 | 13 | 15 | |
| C _{in} | Maximum Input Capacitance | - | 10 | 10 | 10 | pF |
| C _{out} | Maximum Three-State Output Capacitance (Output in High-Impedance State) | - | 15 | 15 | 15 | pF |

8. For propagation delays with loads other than 50 pF, see the ON Semiconductor High-Speed CMOS Data Book (DL129/D).

9. Information on typical parametric values can be found in the ON Semiconductor High-Speed CMOS Data Book (DL129/D).

| C _{PD} | Power Dissipation Capacitance (per Package)* | Typical @ 25°C, V _{CC} = 5.0 V | | pF |
|-----------------|--|---|--|----|
| | | 50 | | |
| | | | | |

*Used to determine the no-load dynamic power consumption: P_D = C_{PD} V_{CC}²f + I_{CC} V_{CC}. For load considerations, see the ON Semiconductor High-Speed CMOS Data Book (DL129/D).

MC74HC589A

TIMING REQUIREMENTS (Input $t_r = t_f = 6$ ns, Note 10)

| Symbol | Parameter | V _{CC} V | Guaranteed Limit | | | Unit |
|---------------------------------|---|----------------------|------------------|--------|---------|------|
| | | | -55°C to 25°C | ≤ 85°C | ≤ 125°C | |
| t _{su} | Minimum Setup Time, A-H to Latch Clock (Figure 7) | 2.0 | 100 | 125 | 150 | ns |
| | | 3.0 | 40 | 50 | 60 | |
| | | 4.5 | 20 | 25 | 30 | |
| | | 6.0 | 17 | 21 | 26 | |
| t _{su} | Minimum Setup Time, Serial Data Input S _A to Shift Clock (Figure 8) | 2.0 | 100 | 125 | 150 | ns |
| | | 3.0 | 40 | 50 | 60 | |
| | | 4.5 | 20 | 25 | 30 | |
| | | 6.0 | 17 | 21 | 26 | |
| t _{su} | Minimum Setup Time, Serial Shift/Parallel Load to Shift Clock (Figure 9) | 2.0 | 100 | 125 | 150 | ns |
| | | 3.0 | 40 | 50 | 60 | |
| | | 4.5 | 20 | 25 | 30 | |
| | | 6.0 | 17 | 21 | 26 | |
| t _h | Minimum Hold Time, Latch Clock to A-H (Figure 7) | 2.0 | 25 | 30 | 40 | ns |
| | | 3.0 | 10 | 12 | 15 | |
| | | 4.5 | 5 | 6 | 8 | |
| | | 6.0 | 5 | 6 | 7 | |
| t _h | Minimum Hold Time, Shift Clock to Serial Data Input S _A (Figure 8) | 2.0 | 5 | 5 | 5 | ns |
| | | 3.0 | 5 | 5 | 5 | |
| | | 4.5 | 5 | 5 | 5 | |
| | | 6.0 | 5 | 5 | 5 | |
| t _w | Minimum Pulse Width, Shift Clock (Figure 4) | 2.0 | 75 | 95 | 110 | ns |
| | | 3.0 | 40 | 50 | 60 | |
| | | 4.5 | 15 | 19 | 23 | |
| | | 6.0 | 13 | 16 | 19 | |
| t _w | Minimum Pulse Width, Latch Clock (Figure 3) | 2.0 | 80 | 100 | 120 | ns |
| | | 3.0 | 40 | 50 | 60 | |
| | | 4.5 | 16 | 20 | 24 | |
| | | 6.0 | 14 | 17 | 20 | |
| t _w | Minimum Pulse Width, Serial Shift/Parallel Load (Figure 6) | 2.0 | 80 | 100 | 120 | ns |
| | | 3.0 | 40 | 50 | 60 | |
| | | 4.5 | 16 | 20 | 24 | |
| | | 6.0 | 14 | 17 | 20 | |
| t _r , t _f | Maximum Input Rise and Fall Times (Figure 3) | 2.0 | 1000 | 1000 | 1000 | ns |
| | | 3.0 | 800 | 800 | 800 | |
| | | 4.5 | 500 | 500 | 500 | |
| | | 6.0 | 400 | 400 | 400 | |

10. Information on typical parametric values can be found in the ON Semiconductor High-Speed CMOS Data Book (DL129/D).

MC74HC589A

FUNCTION TABLE

| Operation | Inputs | | | | | | Resulting Function | | |
|--|---------------|--------------------------------|-------------|-------------|-----------------------------|---------------------|---------------------|---|-----------------------------------|
| | Output Enable | Serial Shift/ Parallel Load | Latch Clock | Shift Clock | Serial Input S _A | Parallel Inputs A-H | Data Latch Contents | Shift Register Contents | Output Q _H |
| Force Output into High Impedance State | H | X | X | X | X | X | X | X | Z |
| Load Parallel Data into Data Latch | L | H | ↗ | L,H ↘ | X | a-h | a-h | U | U |
| Transfer Latch Contents to Shift Register | L | L | L,H ↘ | X | X | X | U | LR _N → SR _N | LR _H |
| Contents of Input Latch and Shift Register are Unchanged | L | H | L,H ↘ | L,H ↘ | X | X | U | U | U |
| Load Parallel Data into Data Latch and Shift Register | L | L | ↗ | X | X | a-h | a-h | a-h | h |
| Shift Serial Data into Shift Register | L | H | X | ↗ | D | X | * | SR _A = D, SR _N → SR _{N+1} | SR _G → SR _H |
| Load Parallel Data in Data Latch and Shift Serial Data into Shift Register | L | H | ↗ | ↗ | D | a-h | a-h | SR _A = D, SR _N → SR _{N+1} | SR _G → SR _H |

LR = latch register contents
 SR = shift register contents
 a-h = data at parallel data inputs A-H
 D = data (L, H) at serial data input S_A

U = remains unchanged
 X = don't care
 Z = high impedance
 * = depends on Latch Clock input

Switching Waveforms

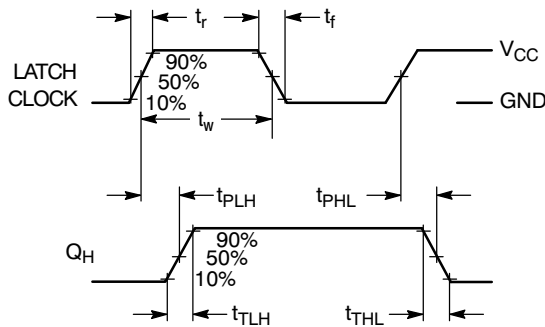

Figure 3. (Serial Shift/Parallel Load = L)

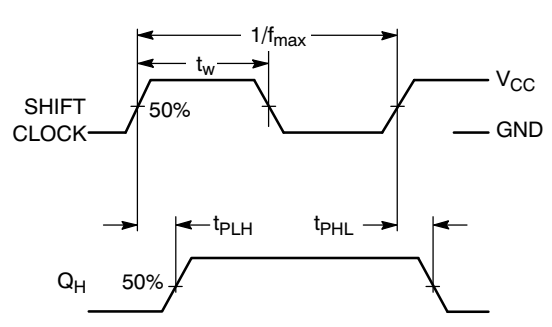

Figure 4. (Serial Shift/Parallel Load = H)

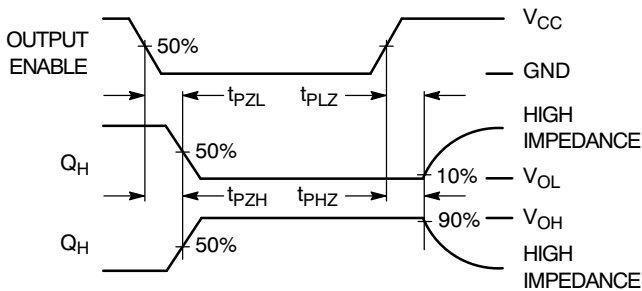

Figure 5.

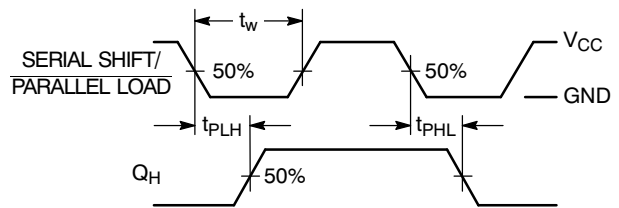

Figure 6.

MC74HC589A

Switching Waveforms

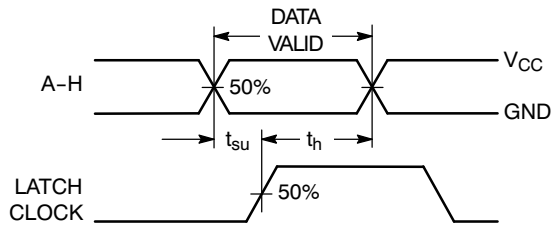

Figure 7.

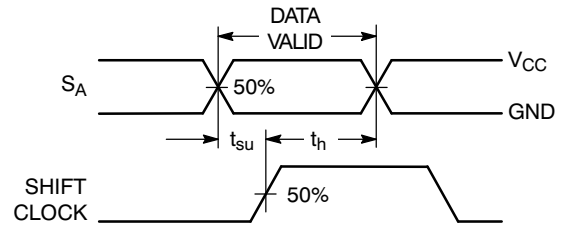

Figure 8.

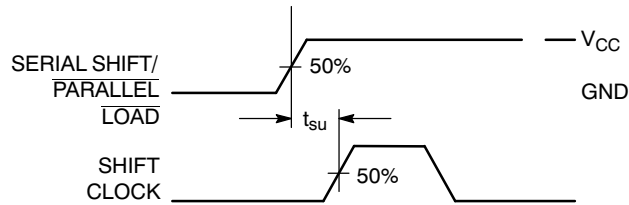
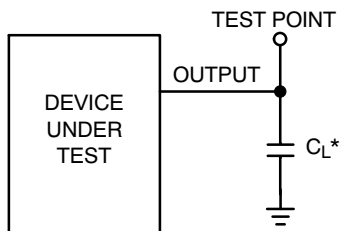
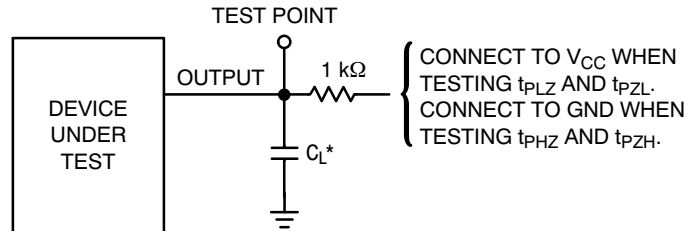

Figure 9.



*Includes all probe and jig capacitance.

Figure 10. Test Circuit



*Includes all probe and jig capacitance.

Figure 11. Test Circuit

Pin Descriptions

Data Inputs

A, B, C, D, E, F, G, H (Pins 15, 1, 2, 3, 4, 5, 6, 7)

Parallel data inputs. Data on these inputs are stored in the data latch on the rising edge of the Latch Clock input.

S_A (Pin 14)

Serial data input. Data on this input is shifted into the shift register on the rising edge of the Shift Clock input if Serial Shift/Parallel Load is high. Data on this input is ignored when Serial Shift/Parallel Load is low.

Control Inputs

Serial Shift/Parallel Load (Pin 13)

Shift register mode control. When a high level is applied to this pin, the shift register is allowed to serially shift data. When a low level is applied to this pin, the shift register accepts parallel data from the data latch.

Shift Clock (Pin 11)

Serial shift clock. A low-to-high transition on this input shifts data on the serial data input into the shift register and

data in stage H is shifted out Q_H, being replaced by the data previously stored in stage G.

Latch Clock (Pin 12)

Data latch clock. A low-to-high transition on this input loads the parallel data on inputs A-H into the data latch.

Output Enable (Pin 10)

Active-low output enable A high level applied to this pin forces the Q_H output into the high impedance state. A low level enables the output. This control does not affect the state of the input latch or the shift register.

Output

Q_H (Pin 9)

Serial data output. This pin is the output from the last stage of the shift register. This is a 3-state output.

MC74HC589A

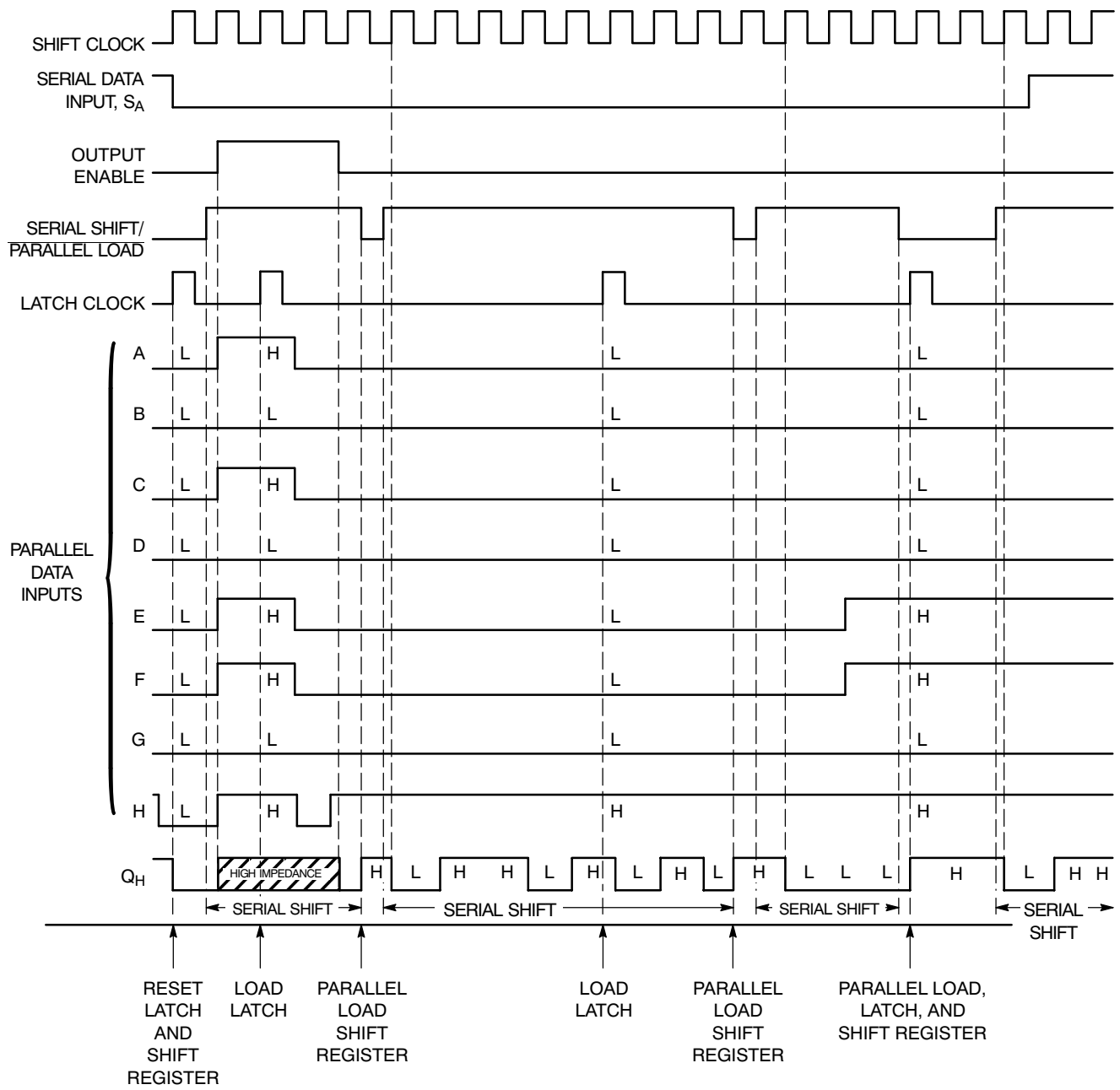
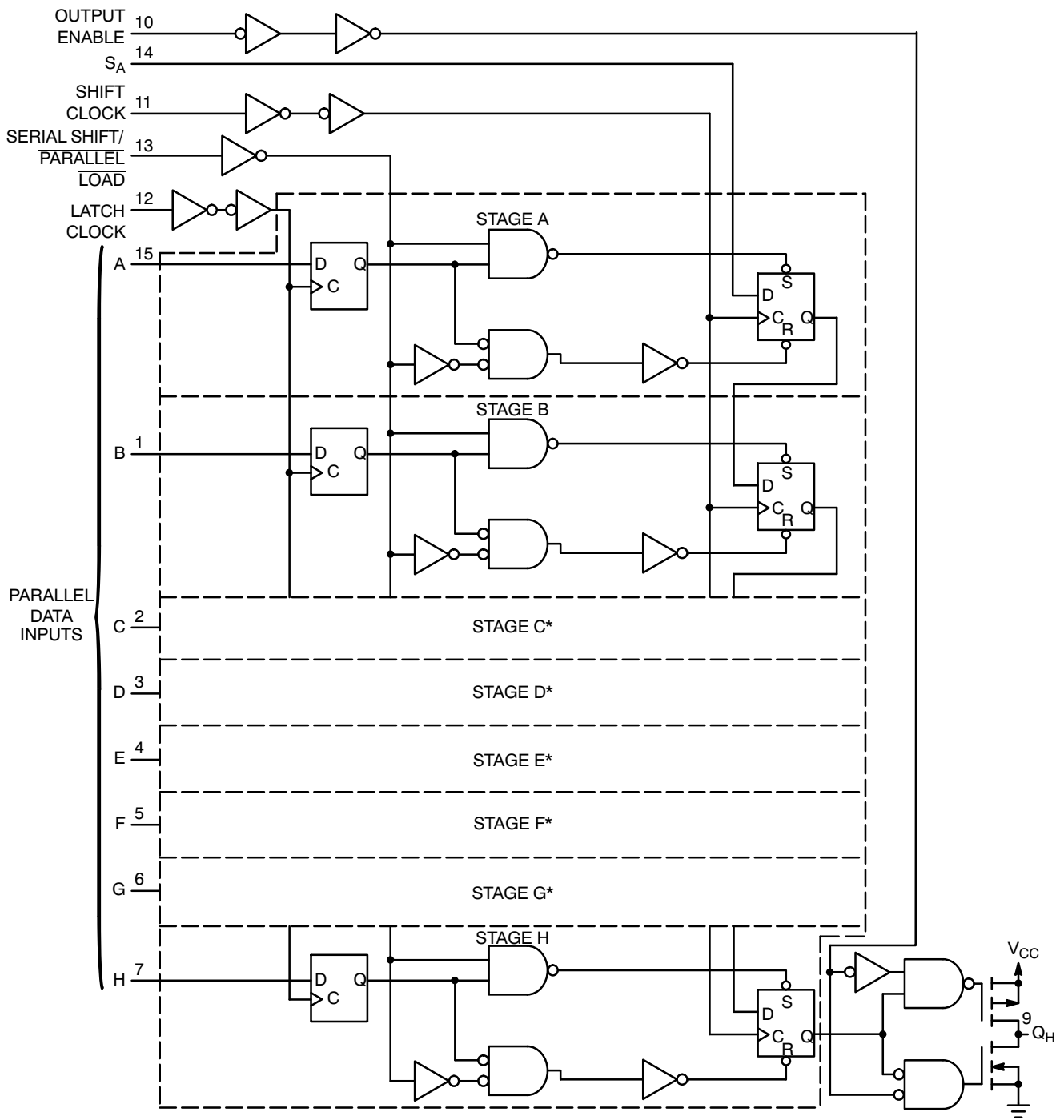

Figure 12. Timing Diagram

MC74HC589A



*Stages C thru G (not shown in detail) are identical to stages A and B above.

Figure 13. Logic Detail

MC74HC589A

PACKAGE DIMENSIONS

PDIP-16
N SUFFIX
CASE 648-08
ISSUE T

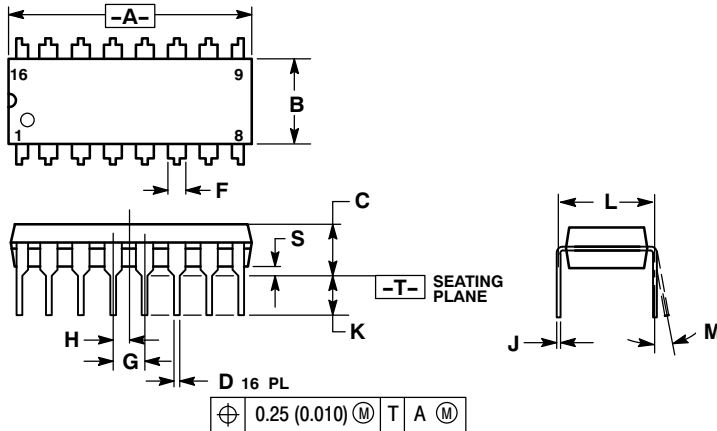

NOTES:

1. DIMENSIONING AND TOLERANCING PER ANSI Y14.5M, 1982.
2. CONTROLLING DIMENSION: INCH.
3. DIMENSION L TO CENTER OF LEADS WHEN FORMED PARALLEL.
4. DIMENSION B DOES NOT INCLUDE MOLD FLASH.
5. ROUNDED CORNERS OPTIONAL.

| DIM | INCHES | | MILLIMETERS | |
|-----|-----------|-------|-------------|-------|
| | MIN | MAX | MIN | MAX |
| A | 0.740 | 0.770 | 18.80 | 19.55 |
| B | 0.250 | 0.270 | 6.35 | 6.85 |
| C | 0.145 | 0.175 | 3.69 | 4.44 |
| D | 0.015 | 0.021 | 0.39 | 0.53 |
| F | 0.040 | 0.70 | 1.02 | 1.77 |
| G | 0.100 BSC | | 2.54 BSC | |
| H | 0.050 BSC | | 1.27 BSC | |
| J | 0.008 | 0.015 | 0.21 | 0.38 |
| K | 0.110 | 0.130 | 2.80 | 3.30 |
| L | 0.295 | 0.305 | 7.50 | 7.74 |
| M | 0° | 10° | 0° | 10° |
| S | 0.020 | 0.040 | 0.51 | 1.01 |

MC74HC589A

PACKAGE DIMENSIONS

SOIC-16
D SUFFIX
CASE 751B-05
ISSUE K

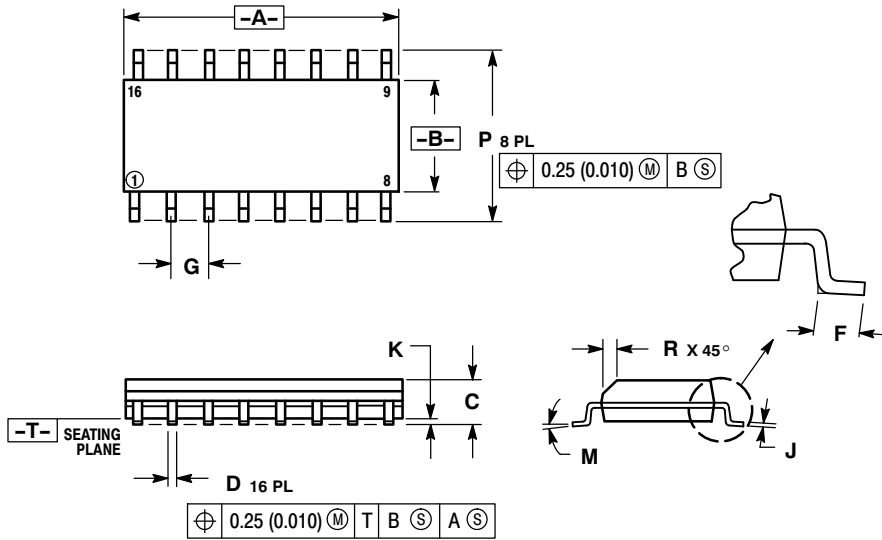

NOTES:

1. DIMENSIONING AND TOLERANCING PER ANSI Y14.5M, 1982.
2. CONTROLLING DIMENSION: MILLIMETER.
3. DIMENSIONS A AND B DO NOT INCLUDE MOLD PROTRUSION.
4. MAXIMUM MOLD PROTRUSION 0.15 (0.006) PER SIDE.
5. DIMENSION D DOES NOT INCLUDE DAMBAR PROTRUSION. ALLOWABLE DAMBAR PROTRUSION SHALL BE 0.127 (0.005) TOTAL IN EXCESS OF THE D DIMENSION AT MAXIMUM MATERIAL CONDITION.

| DIM | MILLIMETERS | | INCHES | |
|-----|-------------|-------|-----------|-------|
| | MIN | MAX | MIN | MAX |
| A | 9.80 | 10.00 | 0.386 | 0.393 |
| B | 3.80 | 4.00 | 0.150 | 0.157 |
| C | 1.35 | 1.75 | 0.054 | 0.068 |
| D | 0.35 | 0.49 | 0.014 | 0.019 |
| F | 0.40 | 1.25 | 0.016 | 0.049 |
| G | 1.27 BSC | | 0.050 BSC | |
| J | 0.19 | 0.25 | 0.008 | 0.009 |
| K | 0.10 | 0.25 | 0.004 | 0.009 |
| M | 0° | 7° | 0° | 7° |
| P | 5.80 | 6.20 | 0.229 | 0.244 |
| R | 0.25 | 0.50 | 0.010 | 0.019 |

SOLDERING FOOTPRINT*

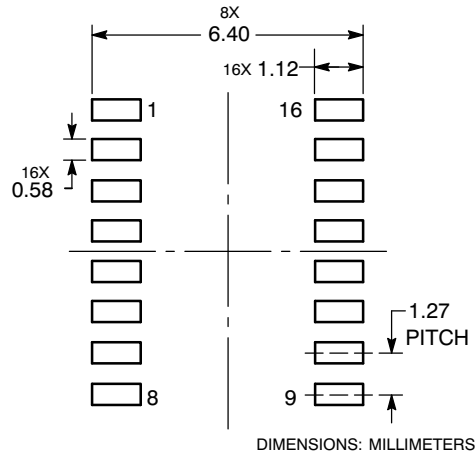

*For additional information on our Pb-Free strategy and soldering details, please download the ON Semiconductor Soldering and Mounting Techniques Reference Manual, SOLDERRM/D.

MC74HC589A

PACKAGE DIMENSIONS

TSSOP-16
DT SUFFIX
CASE 948F-01
ISSUE B

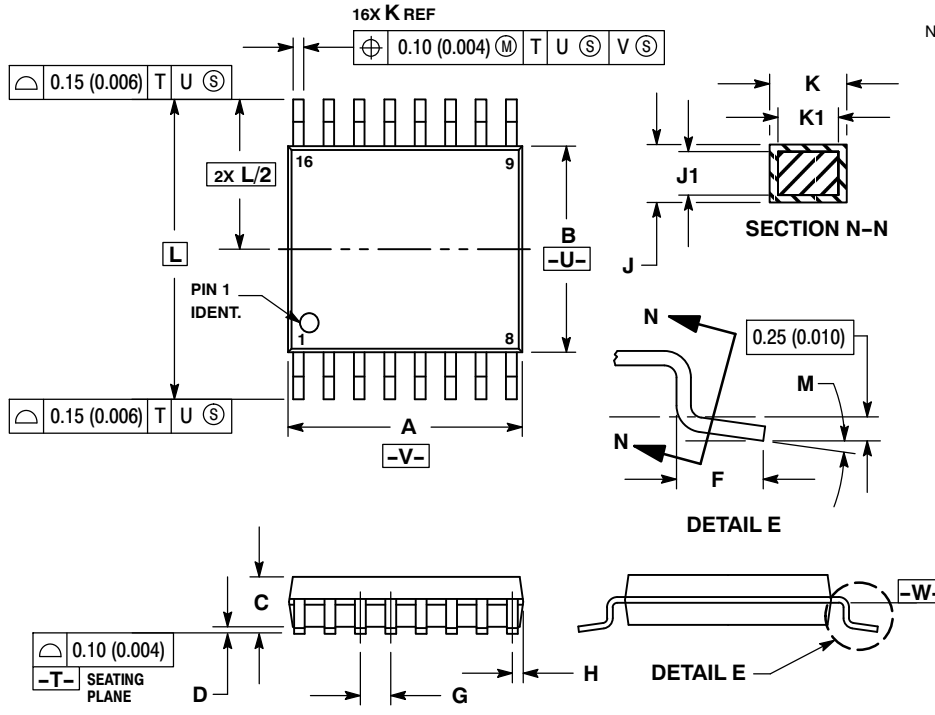

NOTES:

- 1 DIMENSIONING AND TOLERANCING PER ANSI Y14.5M, 1982.
- 2 CONTROLLING DIMENSION: MILLIMETER.
- 3 DIMENSION A DOES NOT INCLUDE MOLD FLASH, PROTRUSIONS OR GATE BURRS. MOLD FLASH OR GATE BURRS SHALL NOT EXCEED 0.15 (0.006) PER SIDE.
- 4 DIMENSION B DOES NOT INCLUDE INTERLEAD FLASH OR PROTRUSION. INTERLEAD FLASH OR PROTRUSION SHALL NOT EXCEED 0.25 (0.010) PER SIDE.
- 5 DIMENSION K DOES NOT INCLUDE DAMBAR PROTRUSION. ALLOWABLE DAMBAR PROTRUSION SHALL BE 0.08 (0.003) TOTAL IN EXCESS OF THE K DIMENSION AT MAXIMUM MATERIAL CONDITION.
- 6 TERMINAL NUMBERS ARE SHOWN FOR REFERENCE ONLY.
- 7 DIMENSION A AND B ARE TO BE DETERMINED AT DATUM PLANE -W-.

| DIM | MILLIMETERS | | INCHES | |
|-----|-------------|------|-----------|-------|
| | MIN | MAX | MIN | MAX |
| A | 4.90 | 5.10 | 0.193 | 0.200 |
| B | 4.30 | 4.50 | 0.169 | 0.177 |
| C | --- | 1.20 | --- | 0.047 |
| D | 0.05 | 0.15 | 0.002 | 0.006 |
| F | 0.50 | 0.75 | 0.020 | 0.030 |
| G | 0.65 BSC | | 0.026 BSC | |
| H | 0.18 | 0.28 | 0.007 | 0.011 |
| J | 0.09 | 0.20 | 0.004 | 0.008 |
| J1 | 0.09 | 0.16 | 0.004 | 0.006 |
| K | 0.19 | 0.30 | 0.007 | 0.012 |
| K1 | 0.19 | 0.25 | 0.007 | 0.010 |
| L | 6.40 BSC | | 0.252 BSC | |
| M | 0° | 8° | 0° | 8° |

SOLDERING FOOTPRINT*

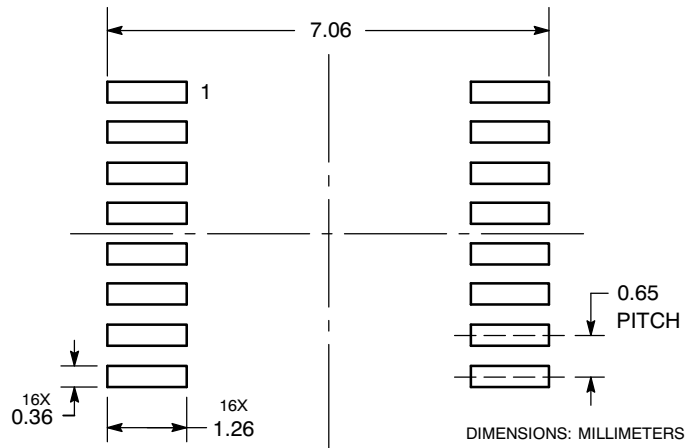

*For additional information on our Pb-Free strategy and soldering details, please download the ON Semiconductor Soldering and Mounting Techniques Reference Manual, SOLDERRM/D.

MC74HC589A

PACKAGE DIMENSIONS

SOEIAJ-16
F SUFFIX
CASE 966-01
ISSUE A

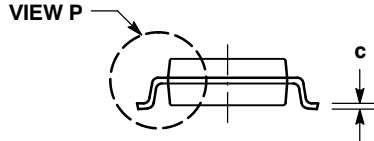
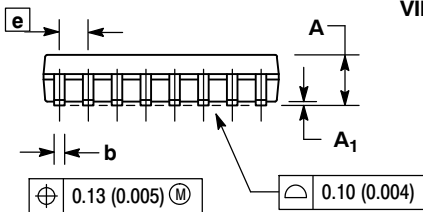
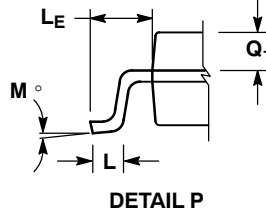
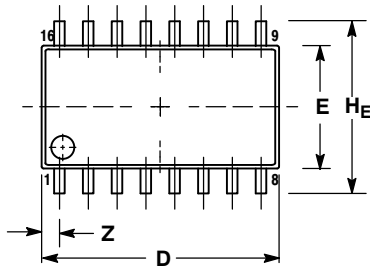

NOTES:

1 DIMENSIONING AND TOLERANCING PER ANSI Y14.5M, 1982.
2 CONTROLLING DIMENSION: MILLIMETER.
3 DIMENSIONS D AND E DO NOT INCLUDE MOLD FLASH OR PROTRUSIONS AND ARE MEASURED AT THE PARTING LINE. MOLD FLASH OR PROTRUSIONS SHALL NOT EXCEED 0.15 (0.006) PER SIDE.
4 TERMINAL NUMBERS ARE SHOWN FOR REFERENCE ONLY.
5 THE LEAD WIDTH DIMENSION (b) DOES NOT INCLUDE DAMBAR PROTRUSION. ALLOWABLE DAMBAR PROTRUSION SHALL BE 0.08 (0.003) TOTAL IN EXCESS OF THE LEAD WIDTH DIMENSION AT MAXIMUM MATERIAL CONDITION. DAMBAR CANNOT BE LOCATED ON THE LOWER RADIUS OR THE FOOT. MINIMUM SPACE BETWEEN PROTRUSIONS AND ADJACENT LEAD TO BE 0.46 (0.018).

| DIM | MILLIMETERS | | INCHES | |
|----------------|-------------|-------|-----------|-------|
| | MIN | MAX | MIN | MAX |
| A | --- | 2.05 | --- | 0.081 |
| A ₁ | 0.05 | 0.20 | 0.002 | 0.008 |
| b | 0.35 | 0.50 | 0.014 | 0.020 |
| c | 0.10 | 0.20 | 0.007 | 0.011 |
| D | 9.90 | 10.50 | 0.390 | 0.413 |
| E | 5.10 | 5.45 | 0.201 | 0.215 |
| e | 1.27 BSC | | 0.050 BSC | |
| HE | 7.40 | 8.20 | 0.291 | 0.323 |
| L | 0.50 | 0.85 | 0.020 | 0.033 |
| LE | 1.10 | 1.50 | 0.043 | 0.059 |
| M | 0° | 10° | 0° | 10° |
| Q ₁ | 0.70 | 0.90 | 0.028 | 0.035 |
| Z | --- | 0.78 | --- | 0.031 |

ON Semiconductor and are registered trademarks of Semiconductor Components Industries, LLC (SCILLC). SCILLC reserves the right to make changes without further notice to any products herein. SCILLC makes no warranty, representation or guarantee regarding the suitability of its products for any particular purpose, nor does SCILLC assume any liability arising out of the application or use of any product or circuit, and specifically disclaims any and all liability, including without limitation special, consequential or incidental damages. "Typical" parameters which may be provided in SCILLC data sheets and/or specifications can and do vary in different applications and actual performance may vary over time. All operating parameters, including "Typicals" must be validated for each customer application by customer's technical experts. SCILLC does not convey any license under its patent rights nor the rights of others. SCILLC products are not designed, intended, or authorized for use as components in systems intended for surgical implant into the body, or other applications intended to support or sustain life, or for any other application in which the failure of the SCILLC product could create a situation where personal injury or death may occur. Should Buyer purchase or use SCILLC products for any such unintended or unauthorized application, Buyer shall indemnify and hold SCILLC and its officers, employees, subsidiaries, affiliates, and distributors harmless against all claims, costs, damages, and expenses, and reasonable attorney fees arising out of, directly or indirectly, any claim of personal injury or death associated with such unintended or unauthorized use, even if such claim alleges that SCILLC was negligent regarding the design or manufacture of the part. SCILLC is an Equal Opportunity/Affirmative Action Employer. This literature is subject to all applicable copyright laws and is not for resale in any manner.

PUBLICATION ORDERING INFORMATION

LITERATURE FULFILLMENT:
Literature Distribution Center for ON Semiconductor
P.O. Box 5163, Denver, Colorado 80217 USA
Phone: 303-675-2175 or 800-344-3860 Toll Free USA/Canada
Fax: 303-675-2176 or 800-344-3867 Toll Free USA/Canada
Email: orderlit@onsemi.com

N. American Technical Support: 800-282-9855 Toll Free
USA/Canada
Europe, Middle East and Africa Technical Support:
Phone: 421 33 790 2910
Japan Customer Focus Center
Phone: 81-3-5773-3850

ON Semiconductor Website: www.onsemi.com
Order Literature: <http://www.onsemi.com/orderlit>

For additional information, please contact your local Sales Representative

MC74HC589A/D