



LET9045C

RF power transistor from the LdmoST family of n-channel enhancement-mode lateral MOSFETs

Features

- Excellent thermal stability
- Common source configuration
- P_{OUT} (@28 V) = 45 W with 18.5 dB gain @ 960 MHz
- P_{OUT} (@36V) = 70 W with 18.5 dB gain @ 960 MHz
- BeO free package
- In compliance with the 2002/95/EC European directive

Description

The LET9045C is a common source N-channel enhancement-mode lateral field-effect RF power transistor designed for broadband commercial and industrial applications at frequencies up to 1.0 GHz. The LET9045C is designed for high gain and broadband performance operating in common source mode at 28 V. It is ideal for base station applications requiring high linearity.

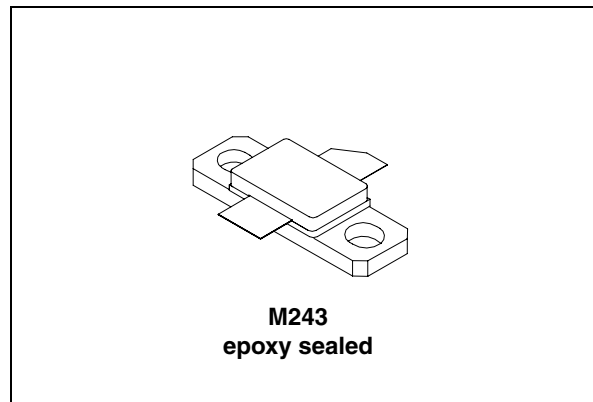

Figure 1. Pin out

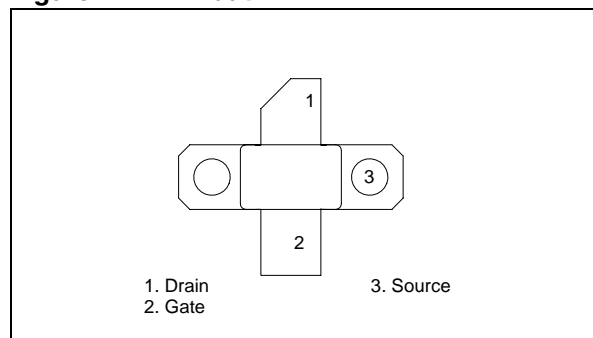

Table 1. Device summary

Order code	Package	Branding
LET9045C	M243	LET9045C

1 Maximum ratings

Table 2. Absolute maximum ratings ($T_{CASE} = 25\text{ °C}$)

Symbol	Parameter	Value	Unit
$V_{(BR)DSS}$	Drain-source voltage	80	V
V_{GS}	Gate-source voltage	-0.5 to +15	V
I_D	Drain current	9	A
P_{DISS}	Power dissipation (@ $T_C = 70\text{ °C}$)	108	W
T_J	Max. operating junction temperature	200	°C
T_{STG}	Storage temperature	-65 to +150	°C

Table 3. Thermal data

Symbol	Parameter	Value	Unit
$R_{th(JC)}$	Junction-case thermal resistance	1.2	°C/W

2 Electrical characteristics

$T_C = 25\text{ }^\circ\text{C}$

Table 4. Static

Symbol	Test conditions	Min.	Typ.	Max.	Unit
$V_{(BR)DSS}$	$V_{GS} = 0\text{ V}; I_{DS} = 10\text{ mA}$	80			V
I_{DSS}	$V_{GS} = 0\text{ V}; V_{DS} = 28\text{ V}$			1	μA
I_{GSS}	$V_{GS} = 20\text{ V}; V_{DS} = 0\text{ V}$			1	μA
$V_{GS(Q)}$	$V_{DS} = 28\text{ V}; I_D = 300\text{ mA}$	2.0		5.0	V
$V_{DS(ON)}$	$V_{GS} = 10\text{ V}; I_D = 3\text{ A}$		0.9	1.2	V
G_{FS}	$V_{DS} = 10\text{ V}; I_D = 3\text{ A}$	2.5			mho
C_{ISS}	$V_{GS} = 0\text{ V}; V_{DS} = 28\text{ V}; f = 1\text{ MHz}$		58		pF
C_{OSS}	$V_{GS} = 0\text{ V}; V_{DS} = 28\text{ V}; f = 1\text{ MHz}$		29		pF
C_{RSS}	$V_{GS} = 0\text{ V}; V_{DS} = 28\text{ V}; f = 1\text{ MHz}$		0.8		pF

Table 5. Dynamic

Symbol	Test conditions	Min.	Typ.	Max.	Unit
P_{OUT}	$V_{DD} = 28\text{ V}; I_{DQ} = 300\text{ mA}; P_{IN} = 1\text{ W}; f = 960\text{ MHz}$	45	59		W
G_{PS}	$V_{DD} = 28\text{ V}; I_{DQ} = 300\text{ mA}; P_{IN} = 1\text{ W}; f = 960\text{ MHz}$	16.5	17.7		dB
h_D	$V_{DD} = 28\text{ V}; I_{DQ} = 300\text{ mA}; P_{IN} = 1\text{ W}; f = 960\text{ MHz}$	60	65		%
Load mismatch	$V_{DD} = 28\text{ V}; I_{DQ} = 300\text{ mA}; P_{IN} = 1\text{ W}; f = 960\text{ MHz}$ All phase angles	10:1			VSWR

3 Impedance data

Figure 2. Impedance data

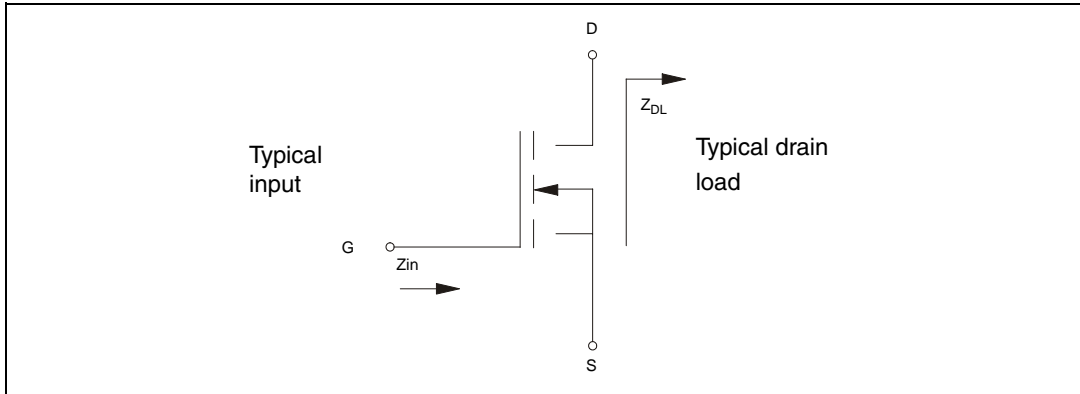

Table 6. Impedance data

Frequency	$Z_{IN} (\Omega)$	$Z_{DL} (\Omega)$
920	$0.8 - j 0.08$	$5.3 + j 0.63$
945	$0.7 - j 0.4$	$5 + j 1.5$
960	$0.6 - j 0.6$	$4.7 + j 2$

4 Typical performances

Figure 3. Gain vs output power and bias current, freq = 960 MHz, Vdd = 28 V

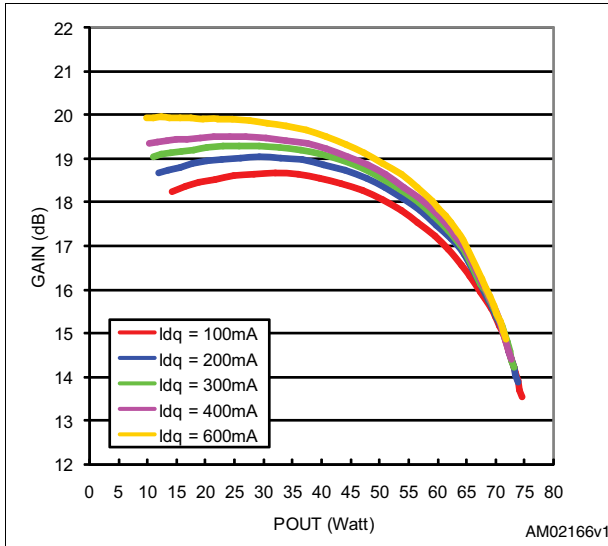

Figure 4. Gain and efficiency vs output power, freq = 960 MHz, Vdd = 28 V, Idq = 300 mA

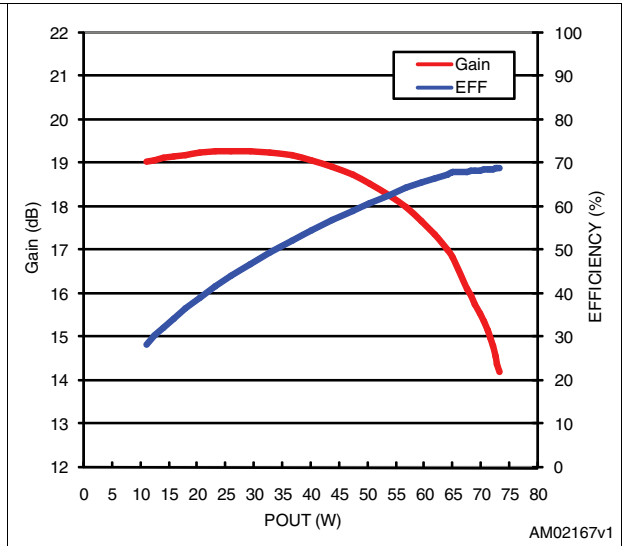
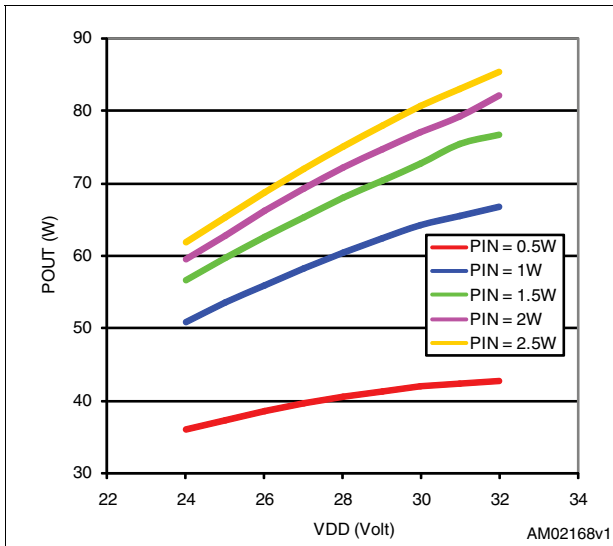

Table 7. Output power vs supply voltage freq = 960 MHz, Vdd = 28 V, Idq = 300 mA



5 Test circuit

Figure 5. Test circuit

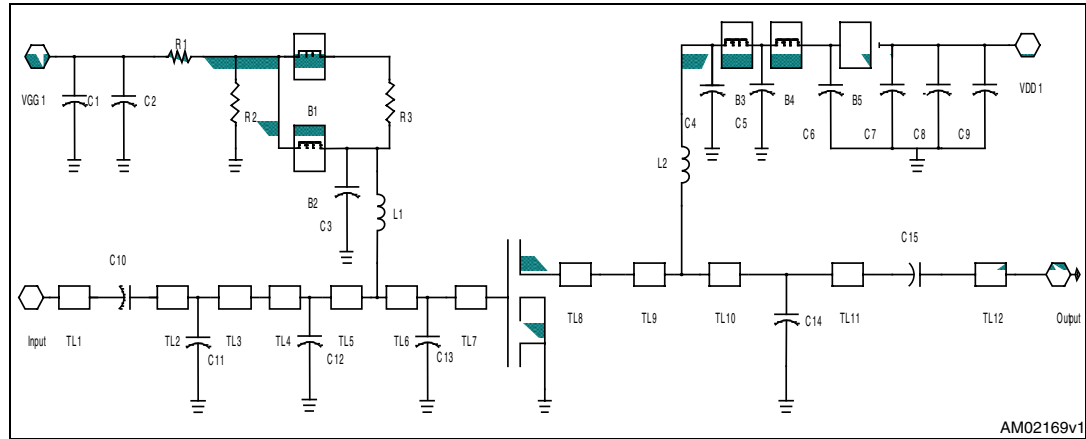

Table 8. LET9045C components list

Item	Qty	Part number	Vendor	Description
R1, R2	2	CR1206-8W-112JB	VENKEL	1.1 kΩ 1/8W surface mount chip resistor
R3	1	CR1206-8W-100JB	VENKEL	10 Ω 1/8W surface mount chip resistor
Coil	2		BELDEN	Inductor 5 turns air WOUND#20AWG ID =0.130 in (3.3 mm) bylon coated
B1,B2,B3,B4,B5	5	2743021447	FAIR-RITE CORP	Surface mount EMI shield bead
C1,C7,C8	3	T491D106K035AT	Kemet	10 μF 35 V tantalum capacitors
C2	1			100 μF 63 V electrolytic capacitor
C3, C4, C10, C15	4	ATC100B470XXXX	ATC	47 pF chip capacitor
C5, C6	2	ATC200B393MW	ATC	39000 pF chip capacitor
C9	1			330 uF 50 V electrolytic capacitor
C11, C13, C14	3	27291PC	Johanson	0.8-8 pF giga trim variable capacitor
C12	1	ATC100B110XXXX	ATC	11 pF chip capacitor
TL1				L = 1.350in [34.29 mm] W = 0.082in [02.08 mm]
TL2				L = 0.144in [3.65 mm] W = 0.082in [02.08 mm]
TL3				L = 0.311in [7.91 mm] W = 0.082in [02.08 mm]
TL4				L = 00.82in [2.09 mm] W = 0.323in [08.21 mm]
TL5				L = 0.194 in [4.94 mm] W = 0.323in [08.21 mm]

Table 8. LET9045C components list (continued)

Item	Qty	Part number	Vendor	Description
TL6				L = 0.059in [1.49 mm] W= 0.506in [12.85 mm]
TL7				L = 0.144in [3.65 mm] W = 0.506in [12.85 mm]
TL8				L = 0.208in [5.28 mm] W = 0.506in [12.85 mm]
TL9				L = 0.275in [6.98 mm] W = 0.323in [08.21 mm]
TL10				L = 0.210in [5.33 mm] W = 0.082in [02.08 mm]
TL11				L = 0.260in [6.60 mm] W = 0.082in [02.08 mm]
TL12				L = 1.350in [34.29 mm] W = 0.082in [02.08 mm]
Board 3X5	1		Rogers corp	Er=2.55 t=0.0026in h=0.030in

Figure 6. Circuit layout

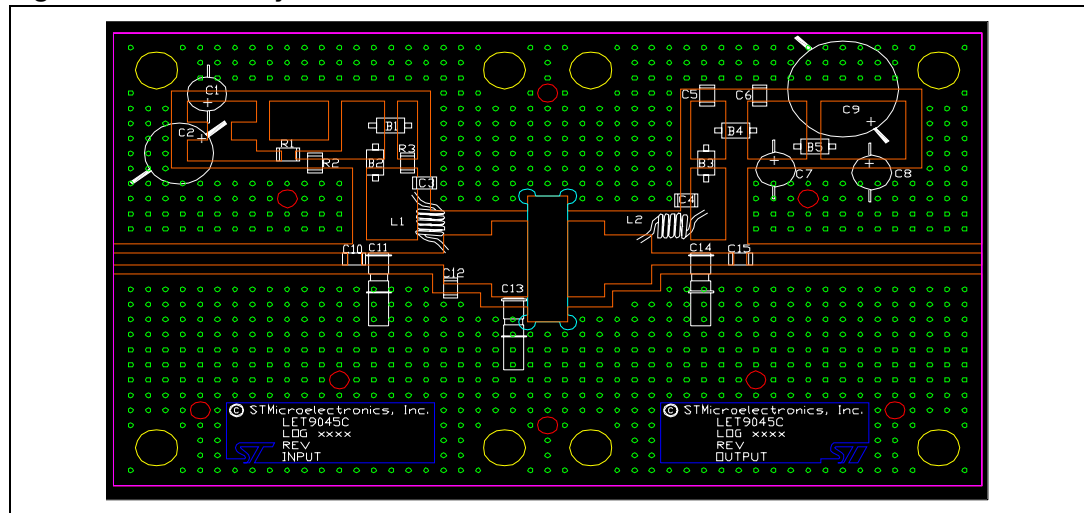

6 Package mechanical data

In order to meet environmental requirements, ST offers these devices in different grades of ECOPACK® packages, depending on their level of environmental compliance. ECOPACK® specifications, grade definitions and product status are available at: www.st.com. ECOPACK® is an ST trademark.

Table 9. M243 (.230 x .360 2L N/HERM W/FLG) mechanical data

Dim.	mm			inch		
	Min.	Typ	Max.	Min.	Typ	Max.
A	5.21		5.72	0.205		0.225
B	5.46		6.48	0.215		0.255
C	5.59		6.1	0.22		0.24
D		14.27			0.562	
E	20.07		20.57	0.79		0.81
F	8.89		9.4	0.35		0.37
G	0.1		0.15	0.004		0.006
H	3.18		4.45	0.125		0.175
I	1.83		2.24	0.072		0.088
J	1.27		1.78	0.05		0.07

Figure 7. M243 package dimensions

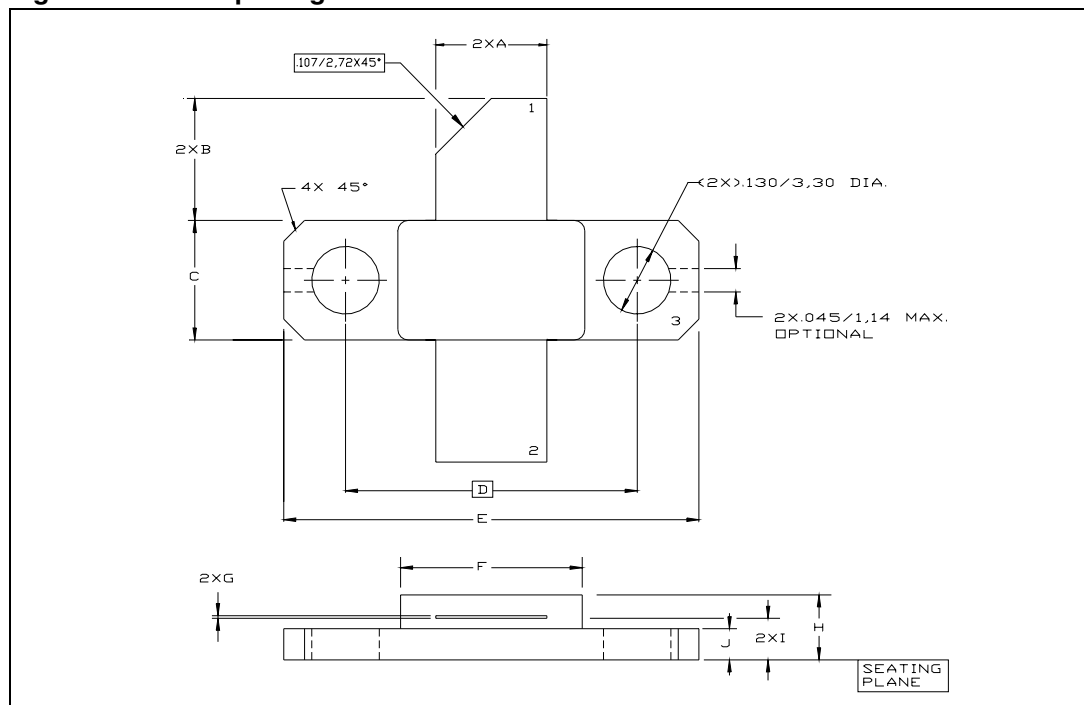

7 Revision history

Table 10. Document revision history

Date	Revision	Changes
02-Mar-2009	1	Initial release.
02-Nov-2009	2	Updated Figure 4 .
11-Feb-2010	3	Changed test condition for $V_{(BR)DSS}$ in Table 4: Static .
15-Apr-2011	4	Updated features in cover page.

Please Read Carefully:

Information in this document is provided solely in connection with ST products. STMicroelectronics NV and its subsidiaries ("ST") reserve the right to make changes, corrections, modifications or improvements, to this document, and the products and services described herein at any time, without notice.

All ST products are sold pursuant to ST's terms and conditions of sale.

Purchasers are solely responsible for the choice, selection and use of the ST products and services described herein, and ST assumes no liability whatsoever relating to the choice, selection or use of the ST products and services described herein.

No license, express or implied, by estoppel or otherwise, to any intellectual property rights is granted under this document. If any part of this document refers to any third party products or services it shall not be deemed a license grant by ST for the use of such third party products or services, or any intellectual property contained therein or considered as a warranty covering the use in any manner whatsoever of such third party products or services or any intellectual property contained therein.

UNLESS OTHERWISE SET FORTH IN ST'S TERMS AND CONDITIONS OF SALE ST DISCLAIMS ANY EXPRESS OR IMPLIED WARRANTY WITH RESPECT TO THE USE AND/OR SALE OF ST PRODUCTS INCLUDING WITHOUT LIMITATION IMPLIED WARRANTIES OF MERCHANTABILITY, FITNESS FOR A PARTICULAR PURPOSE (AND THEIR EQUIVALENTS UNDER THE LAWS OF ANY JURISDICTION), OR INFRINGEMENT OF ANY PATENT, COPYRIGHT OR OTHER INTELLECTUAL PROPERTY RIGHT.

UNLESS EXPRESSLY APPROVED IN WRITING BY AN AUTHORIZED ST REPRESENTATIVE, ST PRODUCTS ARE NOT RECOMMENDED, AUTHORIZED OR WARRANTED FOR USE IN MILITARY, AIR CRAFT, SPACE, LIFE SAVING, OR LIFE SUSTAINING APPLICATIONS, NOR IN PRODUCTS OR SYSTEMS WHERE FAILURE OR MALFUNCTION MAY RESULT IN PERSONAL INJURY, DEATH, OR SEVERE PROPERTY OR ENVIRONMENTAL DAMAGE. ST PRODUCTS WHICH ARE NOT SPECIFIED AS "AUTOMOTIVE GRADE" MAY ONLY BE USED IN AUTOMOTIVE APPLICATIONS AT USER'S OWN RISK.

Resale of ST products with provisions different from the statements and/or technical features set forth in this document shall immediately void any warranty granted by ST for the ST product or service described herein and shall not create or extend in any manner whatsoever, any liability of ST.

ST and the ST logo are trademarks or registered trademarks of ST in various countries.

Information in this document supersedes and replaces all information previously supplied.

The ST logo is a registered trademark of STMicroelectronics. All other names are the property of their respective owners.

© 2011 STMicroelectronics - All rights reserved

STMicroelectronics group of companies

Australia - Belgium - Brazil - Canada - China - Czech Republic - Finland - France - Germany - Hong Kong - India - Israel - Italy - Japan - Malaysia - Malta - Morocco - Philippines - Singapore - Spain - Sweden - Switzerland - United Kingdom - United States of America

www.st.com