

ON Semiconductor

Is Now

onsemi™

To learn more about onsemi™, please visit our website at
www.onsemi.com

onsemi and **onsemi** and other names, marks, and brands are registered and/or common law trademarks of Semiconductor Components Industries, LLC dba "**onsemi**" or its affiliates and/or subsidiaries in the United States and/or other countries. **onsemi** owns the rights to a number of patents, trademarks, copyrights, trade secrets, and other intellectual property. A listing of **onsemi** product/patent coverage may be accessed at www.onsemi.com/site/pdf/Patent-Marking.pdf. **onsemi** reserves the right to make changes at any time to any products or information herein, without notice. The information herein is provided "as-is" and **onsemi** makes no warranty, representation or guarantee regarding the accuracy of the information, product features, availability, functionality, or suitability of its products for any particular purpose, nor does **onsemi** assume any liability arising out of the application or use of any product or circuit, and specifically disclaims any and all liability, including without limitation special, consequential or incidental damages. Buyer is responsible for its products and applications using **onsemi** products, including compliance with all laws, regulations and safety requirements or standards, regardless of any support or applications information provided by **onsemi**. "Typical" parameters which may be provided in **onsemi** data sheets and/or specifications can and do vary in different applications and actual performance may vary over time. All operating parameters, including "Typicals" must be validated for each customer application by customer's technical experts. **onsemi** does not convey any license under any of its intellectual property rights nor the rights of others. **onsemi** products are not designed, intended, or authorized for use as a critical component in life support systems or any FDA Class 3 medical devices or medical devices with a same or similar classification in a foreign jurisdiction or any devices intended for implantation in the human body. Should Buyer purchase or use **onsemi** products for any such unintended or unauthorized application, Buyer shall indemnify and hold **onsemi** and its officers, employees, subsidiaries, affiliates, and distributors harmless against all claims, costs, damages, and expenses, and reasonable attorney fees arising out of, directly or indirectly, any claim of personal injury or death associated with such unintended or unauthorized use, even if such claim alleges that **onsemi** was negligent regarding the design or manufacture of the part. **onsemi** is an Equal Opportunity/Affirmative Action Employer. This literature is subject to all applicable copyright laws and is not for resale in any manner. Other names and brands may be claimed as the property of others.

NJL3281D (NPN) NJL1302D (PNP)

Complementary ThermalTrak™ Transistors

The ThermalTrak family of devices has been designed to eliminate thermal equilibrium lag time and bias trimming in audio amplifier applications. They can also be used in other applications as transistor die protection devices.

Features

- Thermally Matched Bias Diode
- Instant Thermal Bias Tracking
- Absolute Thermal Integrity
- High Safe Operating Area
- Pb-Free Packages are Available*

Benefits

- Eliminates Thermal Equilibrium Lag Time and Bias Trimming
- Superior Sound Quality Through Improved Dynamic Temperature Response
- Significantly Improved Bias Stability
- Simplified Assembly
 - ◆ Reduced Labor Costs
 - ◆ Reduced Component Count
- High Reliability

Applications

- High-End Consumer Audio Products
 - ◆ Home Amplifiers
 - ◆ Home Receivers
- Professional Audio Amplifiers
 - ◆ Theater and Stadium Sound Systems
 - ◆ Public Address Systems (PAs)



ON Semiconductor®

<http://onsemi.com>

**BIPOLAR POWER
TRANSISTORS**
15 AMP, 260 VOLT, 200 WATT

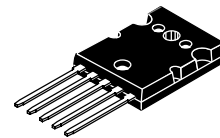

TO-264, 5 LEAD
CASE 340AA
STYLE 1

MARKING DIAGRAM



SCHEMATIC

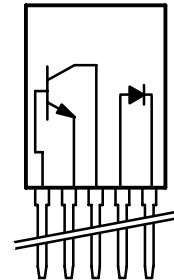

NJLxxxxD = Device Code
 xxxx = 3281 or 1302
 G = Pb-Free Package
 A = Assembly Location
 YY = Year
 WW = Work Week

ORDERING INFORMATION

Device	Package	Shipping
NJL3281D	TO-264	25 Units / Rail
NJL3281DG	TO-264 (Pb-Free)	25 Units / Rail
NJL1302D	TO-264	25 Units / Rail
NJL1302DG	TO-264 (Pb-Free)	25 Units / Rail

*For additional information on our Pb-Free strategy and soldering details, please download the ON Semiconductor Soldering and Mounting Techniques Reference Manual, SOLDERRM/D.

NJL3281D (NPN) NJL1302D (PNP)

MAXIMUM RATINGS (T_J = 25°C unless otherwise noted)

Rating	Symbol	Value	Unit
Collector–Emitter Voltage	V _{CEO}	260	Vdc
Collector–Base Voltage	V _{CBO}	260	Vdc
Emitter–Base Voltage	V _{EBO}	5	Vdc
Collector–Emitter Voltage – 1.5 V	V _{CEX}	260	Vdc
Collector Current – Continuous – Peak (Note 1)	I _C	15 25	Adc
Base Current – Continuous	I _B	1.5	Adc
Total Power Dissipation @ T _C = 25°C Derate Above 25°C	P _D	200 1.43	W W/°C
Operating and Storage Junction Temperature Range	T _J , T _{stg}	– 65 to +150	°C
DC Blocking Voltage	V _R	200	V
Average Rectified Forward Current	I _{F(AV)}	1.0	A

THERMAL CHARACTERISTICS

Characteristic	Symbol	Max	Unit
Thermal Resistance, Junction–to–Case	R _{θJC}	0.625	°C/W

Stresses exceeding Maximum Ratings may damage the device. Maximum Ratings are stress ratings only. Functional operation above the Recommended Operating Conditions is not implied. Extended exposure to stresses above the Recommended Operating Conditions may affect device reliability.

1. Pulse Test: Pulse Width = 5 ms, Duty Cycle < 10%.

ATTRIBUTES

Characteristic	Value
ESD Protection Human Body Model Machine Model	>8000 V > 400 V
Flammability Rating	UL 94 V–0 @ 0.125 in

NJL3281D (NPN) NJL1302D (PNP)

ELECTRICAL CHARACTERISTICS ($T_C = 25^\circ\text{C}$ unless otherwise noted)

Characteristic	Symbol	Min	Max	Unit
OFF CHARACTERISTICS				
Collector-Emitter Sustaining Voltage ($I_C = 100\text{ mAdc}$, $I_B = 0$)	$V_{CEO(sus)}$	260	–	Vdc
Collector Cutoff Current ($V_{CB} = 260\text{ Vdc}$, $I_E = 0$)	I_{CBO}	–	50	μAdc
Emitter Cutoff Current ($V_{EB} = 5\text{ Vdc}$, $I_C = 0$)	I_{EBO}	–	5	μAdc
ON CHARACTERISTICS				
DC Current Gain ($I_C = 500\text{ mAdc}$, $V_{CE} = 5\text{ Vdc}$) ($I_C = 1\text{ Adc}$, $V_{CE} = 5\text{ Vdc}$) ($I_C = 3\text{ Adc}$, $V_{CE} = 5\text{ Vdc}$) ($I_C = 5\text{ Adc}$, $V_{CE} = 5\text{ Vdc}$) ($I_C = 8\text{ Adc}$, $V_{CE} = 5\text{ Vdc}$)	h_{FE}	75 75 75 75 45	150 150 150 150 –	
Collector-Emitter Saturation Voltage ($I_C = 10\text{ Adc}$, $I_B = 1\text{ Adc}$)	$V_{CE(sat)}$	–	3	Vdc
DYNAMIC CHARACTERISTICS				
Current-Gain – Bandwidth Product ($I_C = 1\text{ Adc}$, $V_{CE} = 5\text{ Vdc}$, $f_{test} = 1\text{ MHz}$)	f_T	30	–	MHz
Output Capacitance ($V_{CB} = 10\text{ Vdc}$, $I_E = 0$, $f_{test} = 1\text{ MHz}$)	C_{ob}	–	600	pF
Maximum Instantaneous Forward Voltage (Note 2) ($i_F = 1.0\text{ A}$, $T_J = 25^\circ\text{C}$) ($i_F = 1.0\text{ A}$, $T_J = 150^\circ\text{C}$)	V_F		1.1 0.93	V
Maximum Instantaneous Reverse Current (Note 2) (Rated dc Voltage, $T_J = 25^\circ\text{C}$) (Rated dc Voltage, $T_J = 150^\circ\text{C}$)	i_R		10 100	μA
Maximum Reverse Recovery Time ($i_F = 1.0\text{ A}$, $di/dt = 50\text{ A}/\mu\text{s}$)	t_{rr}		100	ns

2. Diode Pulse Test: Pulse Width = 300 μs , Duty Cycle $\leq 2.0\%$.

NJL3281D (NPN) NJL1302D (PNP)

TYPICAL CHARACTERISTICS

PNP NJL1302D

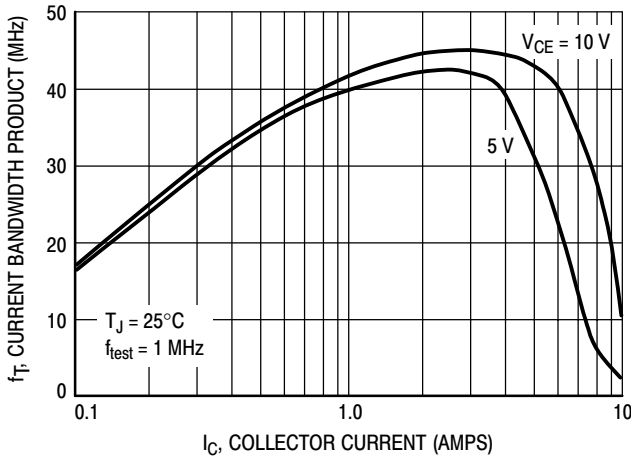

Figure 1. Typical Current Gain Bandwidth Product

NPN NJL3281D

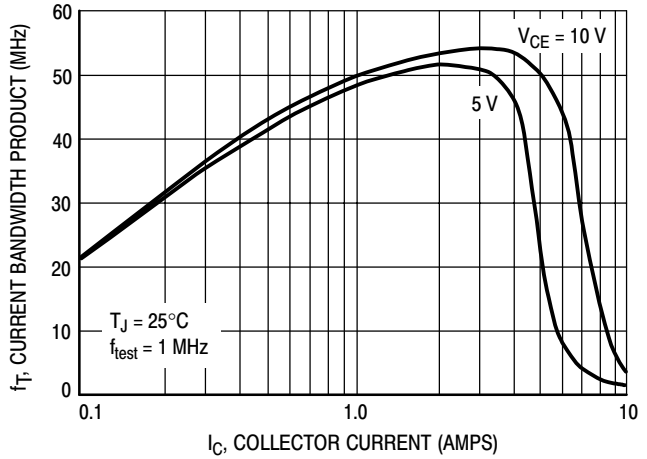

Figure 2. Typical Current Gain Bandwidth Product

PNP NJL1302D

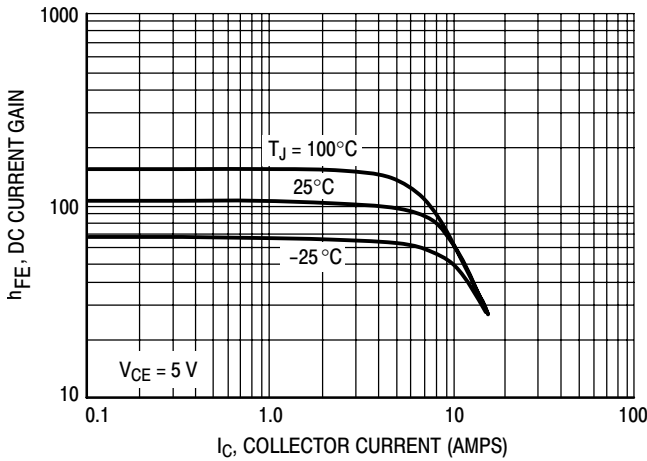

Figure 3. DC Current Gain, $V_{CE} = 5 V$

NPN NJL3281D

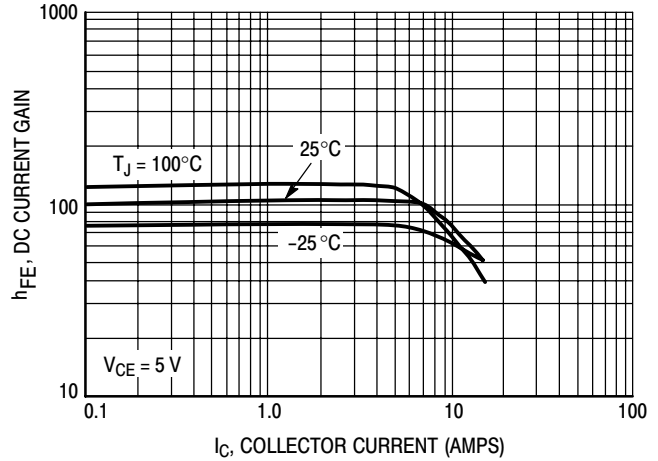

Figure 4. DC Current Gain, $V_{CE} = 5 V$

PNP NJL1302D

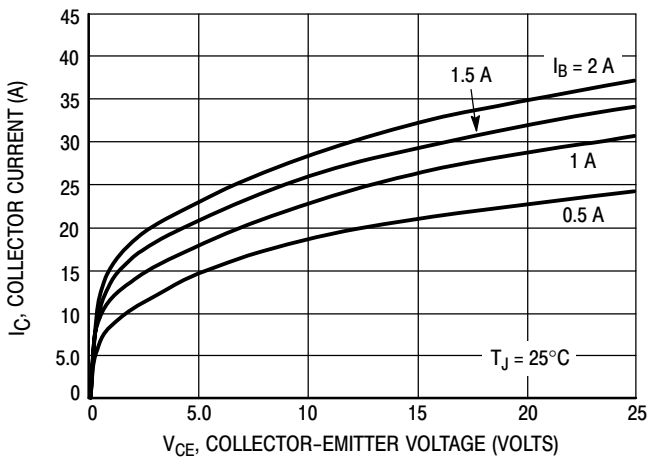

Figure 5. Typical Output Characteristics

NPN NJL3281D

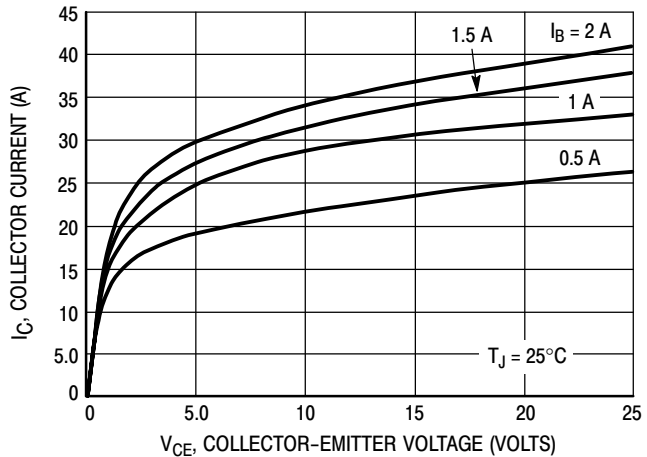

Figure 6. Typical Output Characteristics

NJL3281D (NPN) NJL1302D (PNP)

TYPICAL CHARACTERISTICS

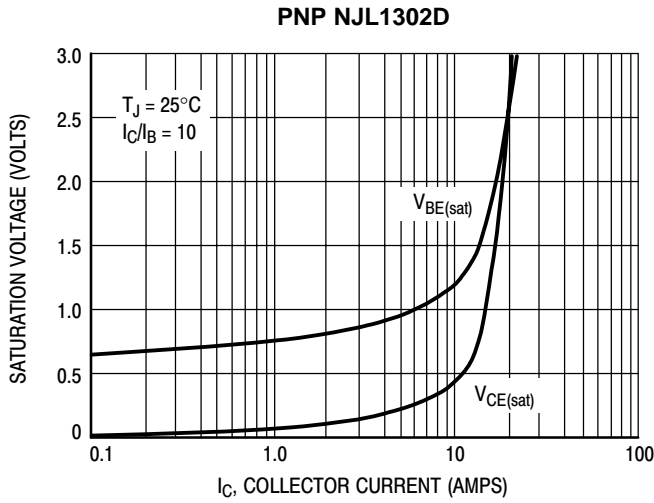

Figure 7. Typical Saturation Voltages

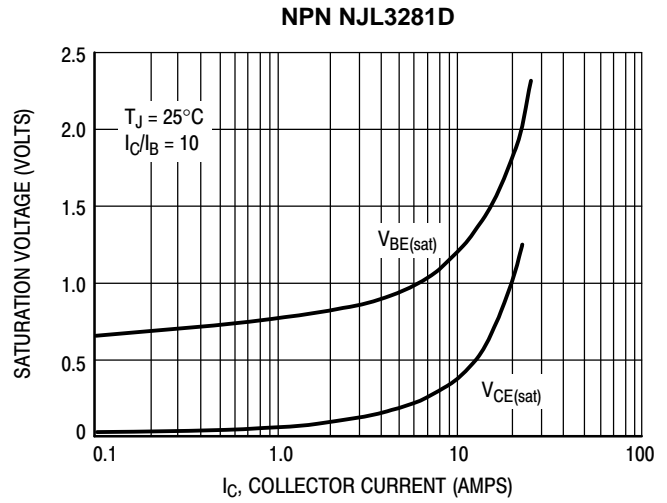

Figure 8. Typical Saturation Voltages

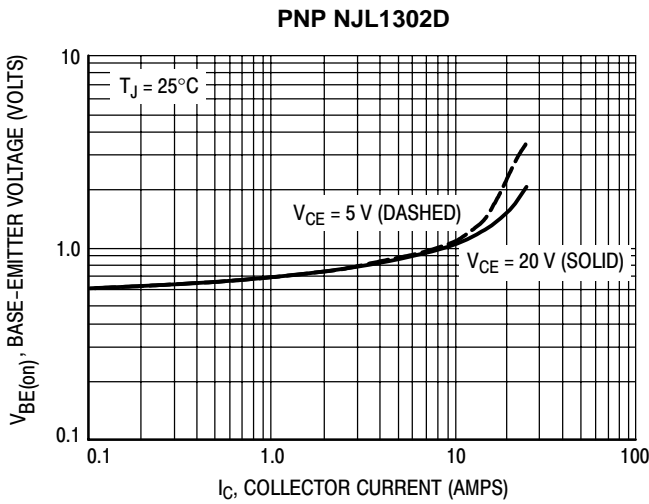

Figure 9. Typical Base-Emitter Voltage

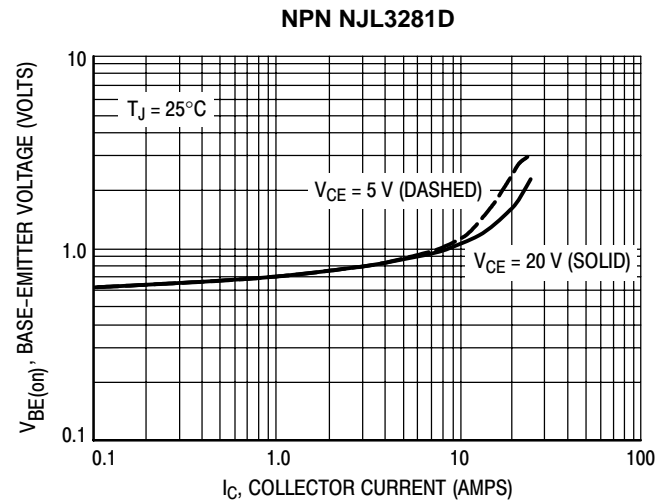

Figure 10. Typical Base-Emitter Voltage

NJL3281D (NPN) NJL1302D (PNP)

TYPICAL CHARACTERISTICS

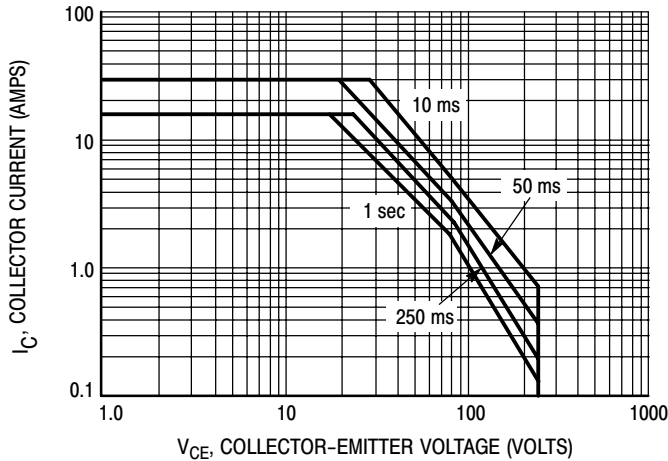

Figure 11. Active Region Safe Operating Area

There are two limitations on the power handling ability of a transistor; average junction temperature and secondary breakdown. Safe operating area curves indicate $I_C - V_{CE}$ limits of the transistor that must be observed for reliable operation; i.e., the transistor must not be subjected to greater dissipation than the curves indicate.

The data of Figure 11 is based on $T_{J(pk)} = 150^\circ\text{C}$; T_C is variable depending on conditions. At high case temperatures, thermal limitations will reduce the power than can be handled to values less than the limitations imposed by second breakdown.

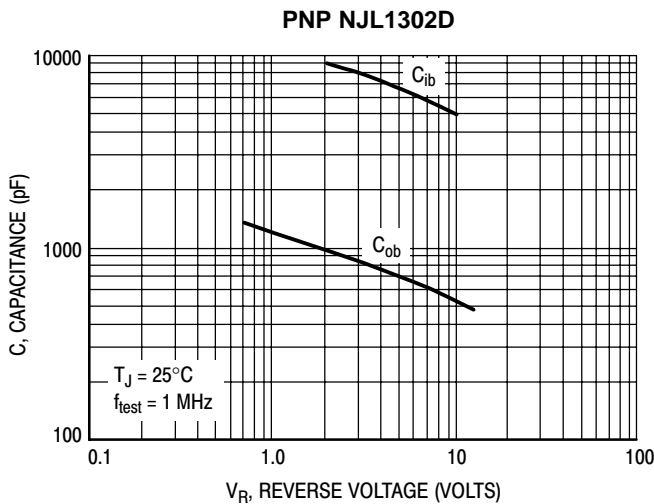

Figure 12. NJL1302D Typical Capacitance

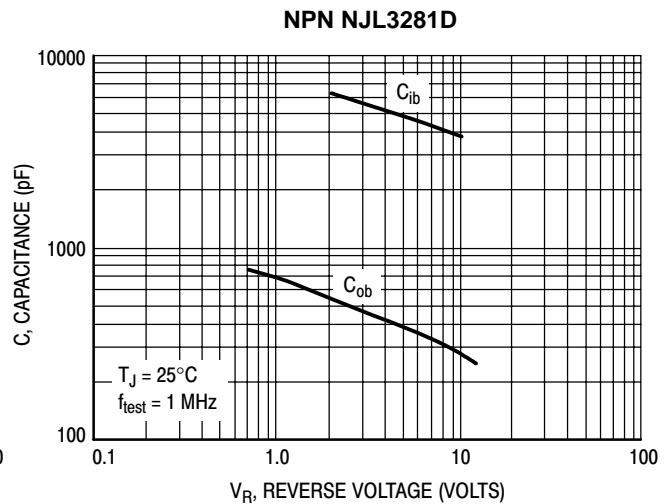

Figure 13. NJL3281D Typical Capacitance

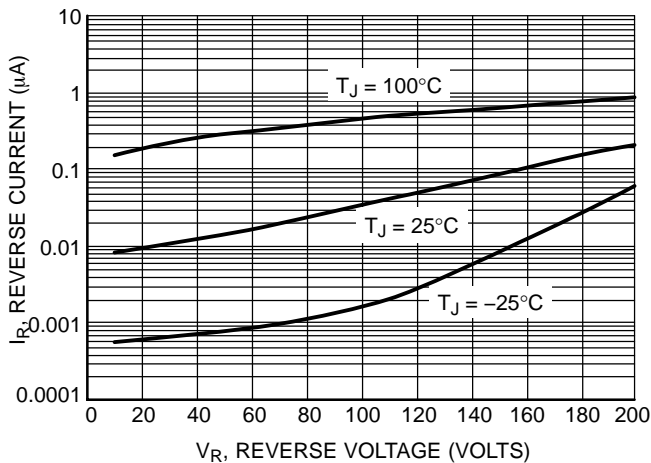

Figure 14. Typical Reverse Current

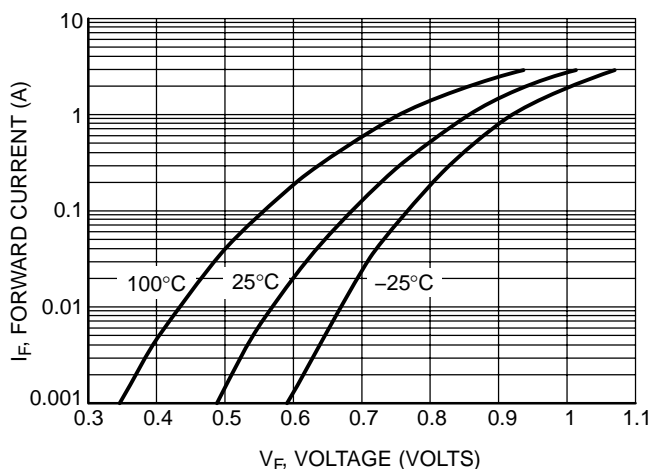

Figure 15. Typical Forward Voltage

ThermalTrak is a trademark of Semiconductor Components Industries, LLC (SCILLC).

MECHANICAL CASE OUTLINE PACKAGE DIMENSIONS

ON Semiconductor®



TO-264, 5 LEAD
CASE 340AA-01
ISSUE O

DATE 03 FEB 2005

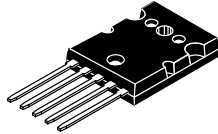

SCALE 1:2

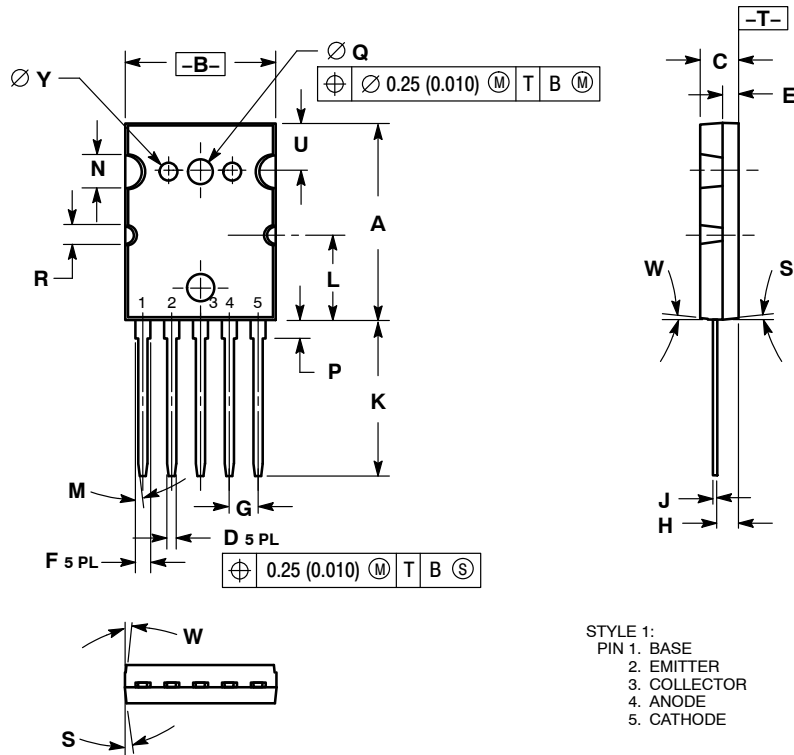

NOTES:
1. DIMENSIONING AND TOLERANCING PER ANSI Y14.5M, 1982.
2. CONTROLLING DIMENSION: MILLIMETER.

DIM	MILLIMETERS			INCHES		
	MIN	NOM	MAX	MIN	NOM	MAX
A	25.857	25.984	26.111	1.018	1.023	1.028
B	19.761	19.888	20.015	0.778	0.783	0.788
C	4.699	4.890	5.182	0.185	0.199	0.204
D	1.219 BSC			0.0480 BSC		
E	1.890	2.042	2.184	0.0748	0.0804	0.0860
F	1.981 BSC			0.0780 BSC		
G	3.81 BSC			0.150 BSC		
H	2.667	2.718	2.769	0.1050	0.1070	0.1090
J	0.584 BSC			0.0230 BSC		
K	20.422	20.549	20.676	0.804	0.809	0.814
L	11.28 REF			0.444 REF		
M	0°	---	7°	0°	---	7°
N	4.57 REF			0.180 REF		
P	2.259	2.386	2.513	0.0889	0.0939	0.0989
Q	3.480 BSC			0.1370 BSC		
R	2.54 REF			0.100 REF		
S	0°	---	8°	0°	---	8°
U	6.17 REF			0.243 REF		
W	0°	---	6°	0°	---	6°
Y	2.388 BSC			0.0940 BSC		

GENERIC MARKING DIAGRAM*

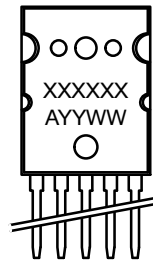

XXXXXX = Specific Device Code
A = Assembly Location
YY = Year
WW = Work Week
G or ■ = Pb-Free Package

*This information is generic. Please refer to device data sheet for actual part marking. Pb-Free indicator, "G" or microdot "■", may or may not be present.

DOCUMENT NUMBER:	98AON19871D	Electronic versions are uncontrolled except when accessed directly from the Document Repository. Printed versions are uncontrolled except when stamped "CONTROLLED COPY" in red.
DESCRIPTION:	TO-264, 5 LEAD	PAGE 1 OF 1

ON Semiconductor and are trademarks of Semiconductor Components Industries, LLC dba ON Semiconductor or its subsidiaries in the United States and/or other countries. ON Semiconductor reserves the right to make changes without further notice to any products herein. ON Semiconductor makes no warranty, representation or guarantee regarding the suitability of its products for any particular purpose, nor does ON Semiconductor assume any liability arising out of the application or use of any product or circuit, and specifically disclaims any and all liability, including without limitation special, consequential or incidental damages. ON Semiconductor does not convey any license under its patent rights nor the rights of others.

ON Semiconductor and  are trademarks of Semiconductor Components Industries, LLC dba ON Semiconductor or its subsidiaries in the United States and/or other countries. ON Semiconductor owns the rights to a number of patents, trademarks, copyrights, trade secrets, and other intellectual property. A listing of ON Semiconductor's product/patent coverage may be accessed at www.onsemi.com/site/pdf/Patent-Marking.pdf. ON Semiconductor reserves the right to make changes without further notice to any products herein. ON Semiconductor makes no warranty, representation or guarantee regarding the suitability of its products for any particular purpose, nor does ON Semiconductor assume any liability arising out of the application or use of any product or circuit, and specifically disclaims any and all liability, including without limitation special, consequential or incidental damages. Buyer is responsible for its products and applications using ON Semiconductor products, including compliance with all laws, regulations and safety requirements or standards, regardless of any support or applications information provided by ON Semiconductor. "Typical" parameters which may be provided in ON Semiconductor data sheets and/or specifications can and do vary in different applications and actual performance may vary over time. All operating parameters, including "Typicals" must be validated for each customer application by customer's technical experts. ON Semiconductor does not convey any license under its patent rights nor the rights of others. ON Semiconductor products are not designed, intended, or authorized for use as a critical component in life support systems or any FDA Class 3 medical devices or medical devices with a same or similar classification in a foreign jurisdiction or any devices intended for implantation in the human body. Should Buyer purchase or use ON Semiconductor products for any such unintended or unauthorized application, Buyer shall indemnify and hold ON Semiconductor and its officers, employees, subsidiaries, affiliates, and distributors harmless against all claims, costs, damages, and expenses, and reasonable attorney fees arising out of, directly or indirectly, any claim of personal injury or death associated with such unintended or unauthorized use, even if such claim alleges that ON Semiconductor was negligent regarding the design or manufacture of the part. ON Semiconductor is an Equal Opportunity/Affirmative Action Employer. This literature is subject to all applicable copyright laws and is not for resale in any manner.

PUBLICATION ORDERING INFORMATION

LITERATURE FULFILLMENT:

Email Requests to: orderlit@onsemi.com

ON Semiconductor Website: www.onsemi.com

TECHNICAL SUPPORT

North American Technical Support:
Voice Mail: 1 800-282-9855 Toll Free USA/Canada
Phone: 011 421 33 790 2910

Europe, Middle East and Africa Technical Support:

Phone: 00421 33 790 2910

For additional information, please contact your local Sales Representative

