

# NSR05F40QNXT5G

## Schottky Diode Optimized for High Frequency Switching Power Supplies

These Schottky barrier diodes are optimized for low forward voltage drop and low leakage current and are offered in a Chip Scale Package (CSP) to reduce board space. The low thermal resistance enables designers to meet the challenging task of achieving higher efficiency and meeting reduced space requirements.

### Features

- Low Forward Voltage Drop – 420 mV @ 500 mA
- Low Reverse Current – 15  $\mu$ A @ 10 V VR
- 500 mA of Continuous Forward Current
- ESD Rating – Human Body Model: Class 3B  
– Machine Model: Class C
- High Switching Speed
- Equivalent Processing and Electrical Performance as NSR05F40NXT5G
- These Devices are Pb-Free, Halogen Free/BFR Free and are RoHS Compliant

### Typical Applications

- LCD and Keypad Backlighting
- Camera Photo Flash
- Buck and Boost dc-dc Converters
- Reverse Voltage and Current Protection
- Clamping and Protection

### Markets

- Mobile Handsets
- MP3 Players
- Digital Camera and Camcorders
- Notebook PCs & PDAs
- GPS

### MAXIMUM RATINGS

Rating	Symbol	Value	Unit
Reverse Voltage	$V_R$	40	V
Forward Current (DC)	$I_F$	500	mA
Forward Surge Current (60 Hz @ 1 cycle)	$I_{FSM}$	10	A
Repetitive Peak Forward Current (Pulse Wave = 1 sec, Duty Cycle = 66%)	$I_{FRM}$	4.0	A
ESD Rating: Human Body Model Machine Model	ESD	> 8 > 400	kV V

Stresses exceeding those listed in the Maximum Ratings table may damage the device. If any of these limits are exceeded, device functionality should not be assumed, damage may occur and reliability may be affected.



ON Semiconductor®

[www.onsemi.com](http://www.onsemi.com)

## 40 V SCHOTTKY BARRIER DIODE

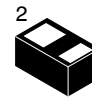

DSN2  
(0402)  
CASE 152AC

### MARKING DIAGRAMS

PIN 1



05F40 = Specific Device Code  
YYY = Year Code

PIN 1



AC = Specific Device Code  
M = Date Code

### ORDERING INFORMATION

Device	Package	Shipping†
NSR05F40QNXT5G	DSN2 (Pb-Free)	5000 / Tape & Reel

†For information on tape and reel specifications, including part orientation and tape sizes, please refer to our Tape and Reel Packaging Specifications Brochure, BRD8011/D.

# NSR05F40QNXT5G

## THERMAL CHARACTERISTICS

Characteristic	Symbol	Min	Typ	Max	Unit
Thermal Resistance Junction-to-Ambient (Note 1) Total Power Dissipation @ $T_A = 25^\circ\text{C}$	$R_{\theta JA}$ $P_D$			240 521	$^\circ\text{C}/\text{W}$ mW
Thermal Resistance Junction-to-Ambient (Note 2) Total Power Dissipation @ $T_A = 25^\circ\text{C}$	$R_{\theta JA}$ $P_D$			94 1.3	$^\circ\text{C}/\text{W}$ W
Storage Temperature Range	$T_{stg}$			-40 to +125	$^\circ\text{C}$
Junction Temperature	$T_J$			+150	$^\circ\text{C}$

1. Mounted onto a 4 in square FR-4 board 50 mm sq. 1 oz. Cu 0.06" thick single sided. Operating to steady state.
2. Mounted onto a 4 in square FR-4 board 1 in sq. 1 oz. Cu 0.06" thick single sided. Operating to steady state.

## ELECTRICAL CHARACTERISTICS ( $T_A = 25^\circ\text{C}$ unless otherwise noted)

Characteristic	Symbol	Min	Typ	Max	Unit
Reverse Leakage ( $V_R = 10\text{ V}$ ) ( $V_R = 40\text{ V}$ )	$I_R$			15 75	$\mu\text{A}$
Forward Voltage ( $I_F = 100\text{ mA}$ ) ( $I_F = 500\text{ mA}$ )	$V_F$		0.340 0.420	0.360 0.460	V

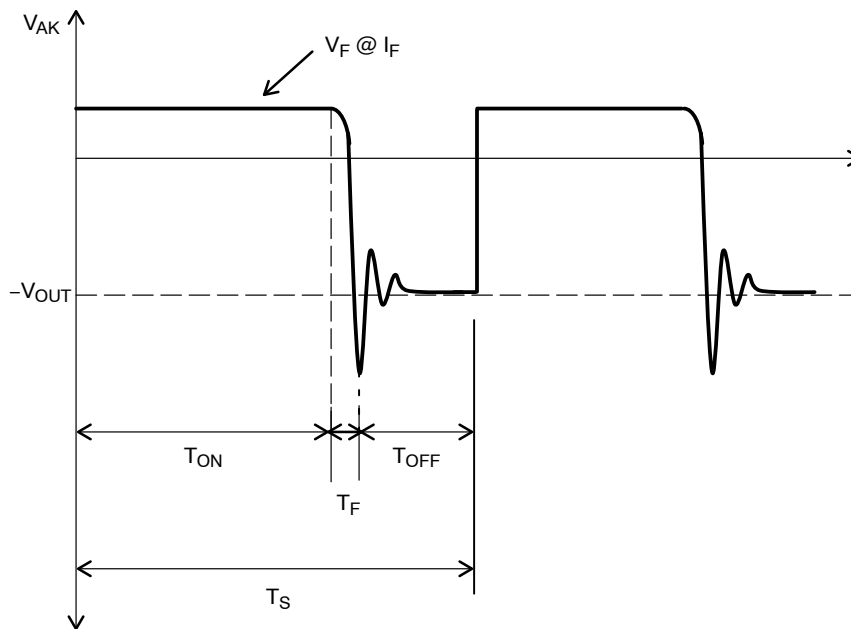

Figure 1. Voltage Waveform of Schottky Diode in Boost Application

# NSR05F40QNXT5G

## TYPICAL CHARACTERISTICS

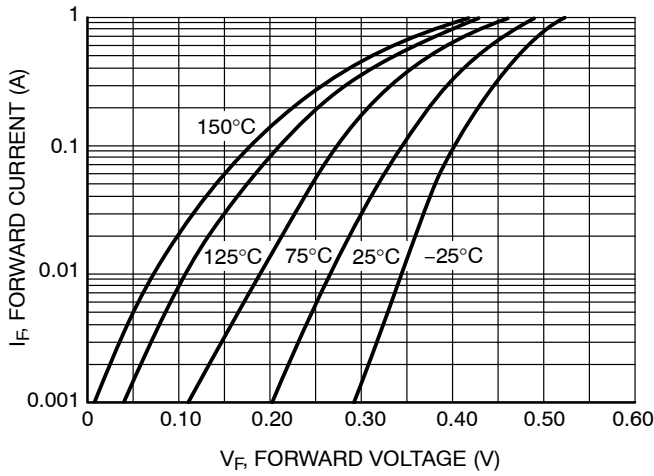

Figure 2. Forward Voltage

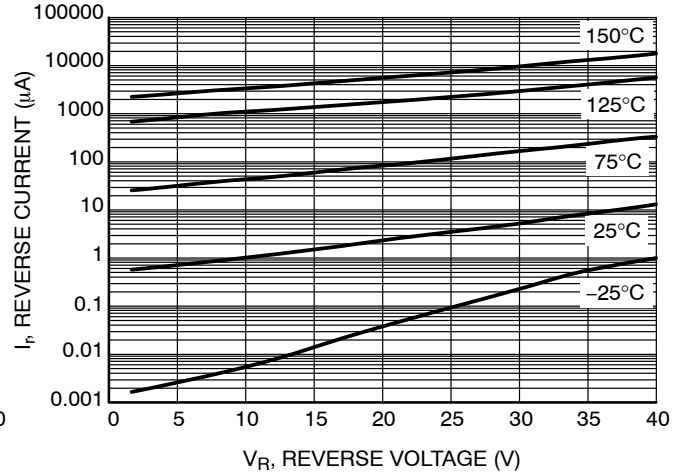

Figure 3. Leakage Current

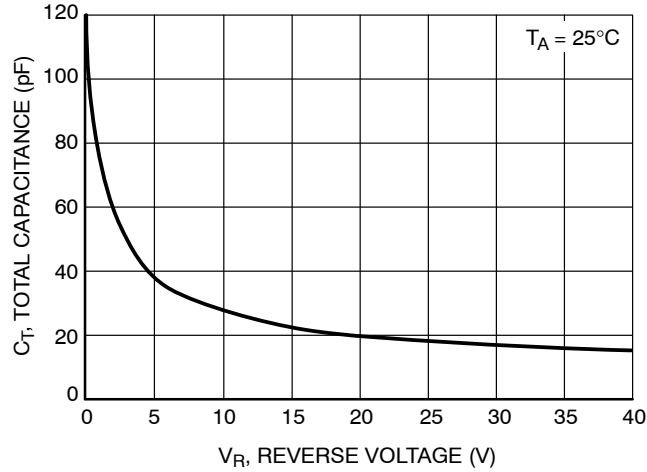

Figure 4. Total Capacitance

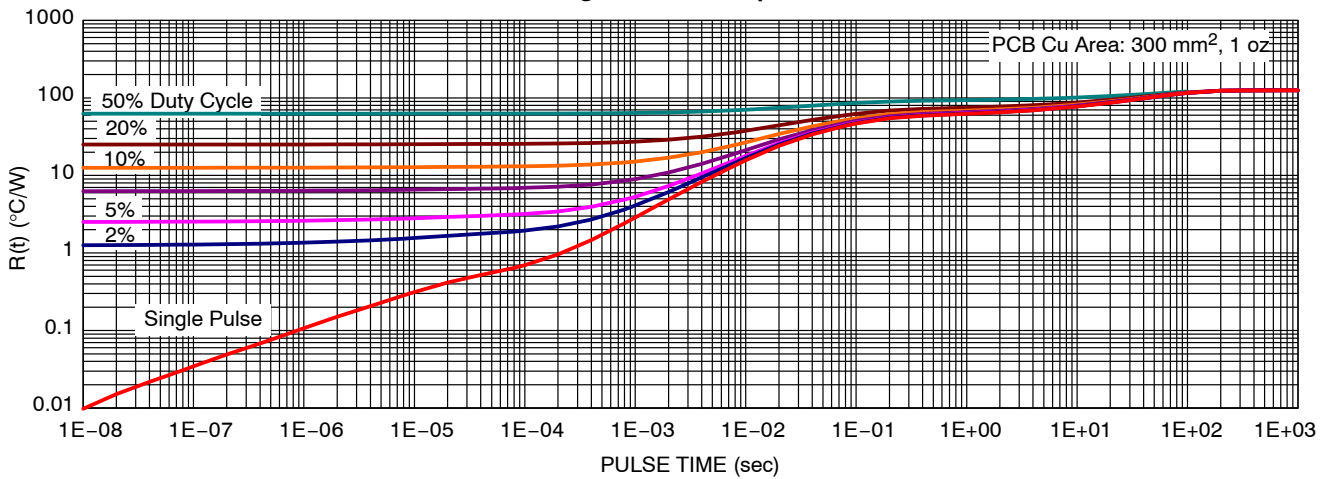

Figure 5. Thermal Resistance

## APPLICATION SECTION

### Introduction

As wireless devices become smaller and thinner more compact, energy efficient, solutions are necessary. To reduce the solution size many people will integrate various discrete devices into the IC. While this may physically reduce the part count this has some adverse side effects, such as performance degradation. The best way to improve the solution is to use optimized discrete devices that have been shrunk and electrically optimized. In this paper we will discuss the intricacies of choosing an optimized schottky diode for wireless devices.

First a discussion of high frequency boost converters as an application is explored. Then various trends in space saving and energy saving design will be discussed. Finally a stress test and a bench tests are shown.

### Background – Application

Most mobile phones use white LEDs to backlight the LCD display. These white LEDs typically have a forward voltage near 3.6 V. Since the typical power source in a mobile phone is a single-cell Li-Ion battery that has an input voltage range of 2.7 V to 4.2 V. Since more than one LED is required to backlight a LCD panel either a single string (~up to 10 LEDs in series) or multiple strings of LEDs (~ up to 10 LEDs in series) in parallel are used.

An example of a single string inductive boost circuit is shown in Figure 6. Typically, a very small voltage is measured over a precision resistor in series with the LEDs to feedback the output operation condition to the controller. Many of today's controllers integrate the transistors and the diode to save space.

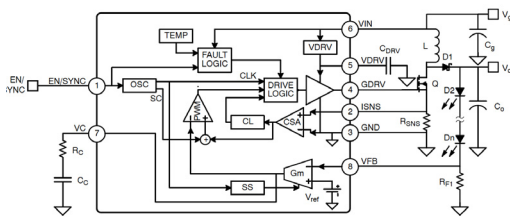

**Figure 6. Simplified Typical Single Channel Converter**

### Space Saving Ideas

The real issue with integrating all of the devices into the controller is that these power devices have an increased junction temperature compared to the controller. This increased junction temperature can lead to reliability issues due to the limited thermal conductivity of I.C. packages.

Another method for shrinking the size of an inductive boost application is to increase the switching frequency. When the switching frequency is increased a lower value inductors can be used to keep a constant inductor current

ripple. Lower value capacitors can be used because they become re-charged more frequently.

Unfortunately the transistor and the diode still need to carry the same average and peak currents. The LEDs for a backlight are generally set between 20 – 150 mA. This means that the transistor and diode need to conduct up to and above 1 A of current. If every element shrinks with exception to the diode and FET then all of this effort is for nothing. ON Semiconductor's High Frequency optimized schottky diodes solve this problem.

### Using ON Semiconductor's Optimized Schottky Diodes

To continue to reduce space requirements for a non-integrated, inductive boost circuit, a diode and a transistor with low power dissipation during operation in a package with high thermal conductivity is necessary. With the compact nature of wireless applications the space is very constrained and there is no place for a large heat sink (so a thermally efficient package is required).

Typically for a 1 A diode with a  $R_{\theta JA} = 86^{\circ}\text{C/W}$  a SMA package is used. The SMA package is 5.21 mm x 2.60 mm x 2.10 mm (L x W x H). ON Semiconductor's new optimized Schottky diode line these packages have a  $R_{\theta JA} = 85 \text{ C/W}$  and are only 1.4 mm x 0.6 mm x 0.27 mm (L x W x H). This means that the same power can be dissipated in only 8% of the total space. Not only is there is a thermal conductivity density advantage but there is also a performance improvement with these new optimized Schottky diodes.

### Thermal Stress Testing Bench Results

Before being tested a set of NSR05F40QNXT5G Boost Optimized Schottky diodes were characterized for forward voltage and reverse current over temperature. Next these diodes were placed in a "1 MHz" Boost converter, operating at near 750 kHz.

To augment the electrical stress seen on the ON Semiconductor Schottky Diodes an inductive boost regulator was set up with the following criteria: Input Voltage = 2.3 V, Output Voltage = 32 V, Output Load Current = 150 mA,  $L1 = 10 \mu\text{H}$ . This will cause higher than normal currents to conduct through the diode.

To further augment the stress seen by the Schottky diode a thermal component to the test was added when the Schottky diodes were mounted to external PCBs with only a minimum footprint pad size. Twisted, shielded pair cable with an inductance of less then  $0.125 \mu\text{H}$  attached the diode PCBs to the "1 MHz" Boost board. This additional inductance is modeled in Figure 7 as Lapra1 and Lpara2 and seen as ringing. These cables allowed for the diode to run inside of an oven set to  $85^{\circ}\text{C}$  for 48 Hours.

After the 48-hour test was completed the diodes were taken back to the characterization lab for a post condition

# NSR05F40QNXT5G

analysis. This analysis showed that there was no shift in any of the parameters, forward voltage, reverse leakage current, and capacitance.

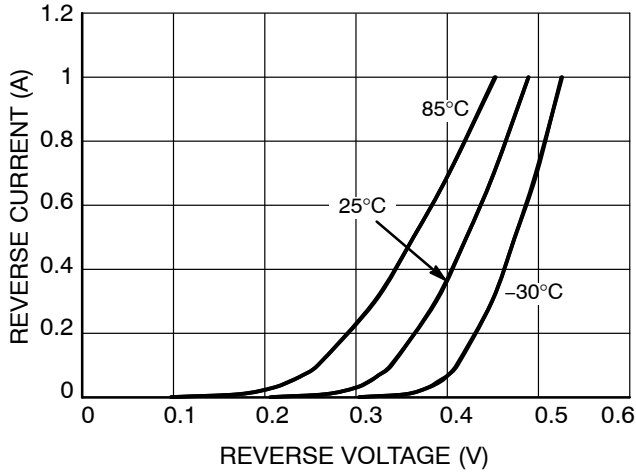

Figure 7. Reverse Leakage Characteristics

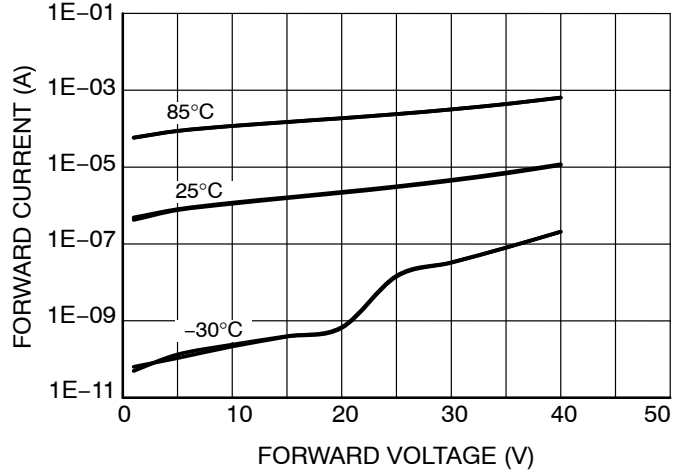

Figure 8. Forward Current Characterization

Finally these diodes were placed in the same circuit at 25°C for 1 week of continuous operation. The screen shots below in Figures 9 and 10 show the operation on the first day of continuous operation and 5 days respectively.

To further evaluate the performance, a thermal camera was used to take pictures of the NSR05F40QNXT5G during heavy load operation and 25°C. As seen in Figure 11 the case only got to 29.2°C. This translates to less than 20 mW of total power dissipation.

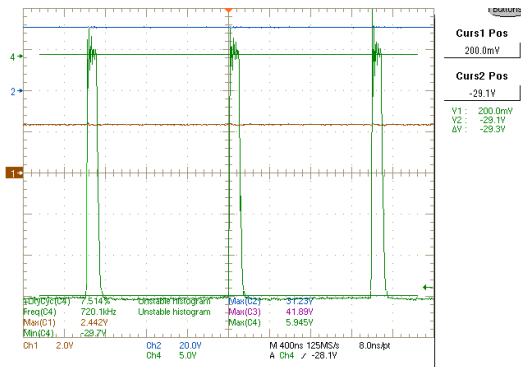

Figure 9. NSR05F40QNXT5G on Day 1 at 25°C

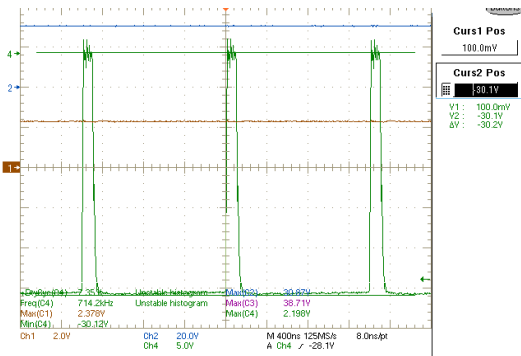

Figure 10. NSR05F40QNXT5G on Day 5 at 25°C

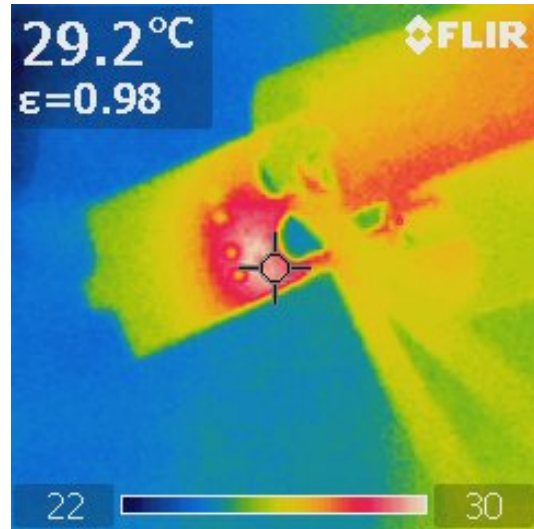

Figure 11. Case Temperature of NSR05F40QNXT5G in Operation at 25°C, 150 mA 34 V Output

With a heavy load condition (up to 1.2 A) through the NSR05F40QNXT5G on a minimum pad size the ambient temperature can rise up to 145°C and not degrade the performance. Using ON Semiconductor’s new ultra low profile Wireless Boost Application Optimized Schottky diodes will increase the overall efficiency and battery life while reducing board size and cost associated with thermal pads.

# NSR05F40QNXT5G

## PACKAGE DIMENSIONS

DSN2, 1.0x0.6, 0.575P, (0402)  
CASE 152AC  
ISSUE D

- NOTES:  
1. DIMENSIONING AND TOLERANCING PER ASME Y14.5M, 1994.  
2. CONTROLLING DIMENSION: MILLIMETERS.

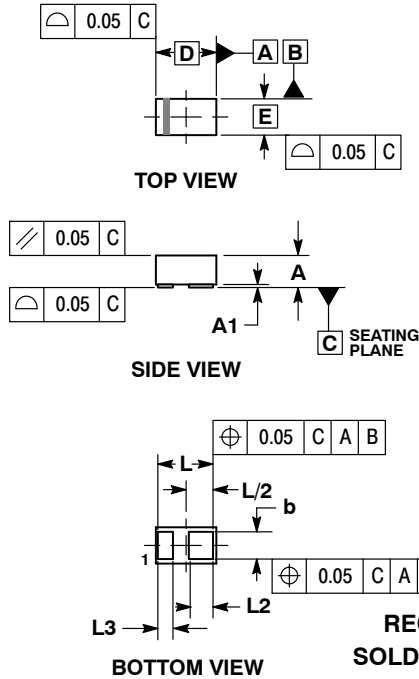

MILLIMETERS		
DIM	MIN	MAX
A	0.25	0.31
A1	---	0.05
b	0.45	0.55
D	1.00 BSC	
E	0.60 BSC	
L	0.85	0.95
L2	0.35	0.45
L3	0.20	0.30

### CATHODE BAND MONTH CODING

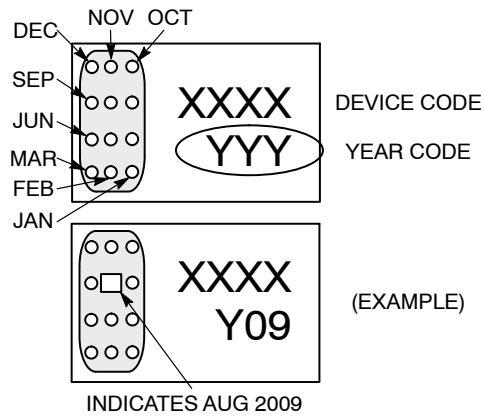

See Application Note AND8464/D for more mounting details

\*For additional information on our Pb-Free strategy and soldering details, please download the ON Semiconductor Soldering and Mounting Techniques Reference Manual, SOLDERRM/D.

ON Semiconductor and are trademarks of Semiconductor Components Industries, LLC dba ON Semiconductor or its subsidiaries in the United States and/or other countries. ON Semiconductor owns the rights to a number of patents, trademarks, copyrights, trade secrets, and other intellectual property. A listing of ON Semiconductor's product/patent coverage may be accessed at [www.onsemi.com/site/pdf/Patent-Marketing.pdf](http://www.onsemi.com/site/pdf/Patent-Marketing.pdf). ON Semiconductor reserves the right to make changes without further notice to any products herein. ON Semiconductor makes no warranty, representation or guarantee regarding the suitability of its products for any particular purpose, nor does ON Semiconductor assume any liability arising out of the application or use of any product or circuit, and specifically disclaims any and all liability, including without limitation special, consequential or incidental damages. Buyer is responsible for its products and applications using ON Semiconductor products, including compliance with all laws, regulations and safety requirements or standards, regardless of any support or applications information provided by ON Semiconductor. "Typical" parameters which may be provided in ON Semiconductor data sheets and/or specifications can and do vary in different applications and actual performance may vary over time. All operating parameters, including "Typicals" must be validated for each customer application by customer's technical experts. ON Semiconductor does not convey any license under its patent rights nor the rights of others. ON Semiconductor products are not designed, intended, or authorized for use as a critical component in life support systems or any FDA Class 3 medical devices or medical devices with a same or similar classification in a foreign jurisdiction or any devices intended for implantation in the human body. Should Buyer purchase or use ON Semiconductor products for any such unintended or unauthorized application, Buyer shall indemnify and hold ON Semiconductor and its officers, employees, subsidiaries, affiliates, and distributors harmless against all claims, costs, damages, and expenses, and reasonable attorney fees arising out of, directly or indirectly, any claim of personal injury or death associated with such unintended or unauthorized use, even if such claim alleges that ON Semiconductor was negligent regarding the design or manufacture of the part. ON Semiconductor is an Equal Opportunity/Affirmative Action Employer. This literature is subject to all applicable copyright laws and is not for resale in any manner.

### PUBLICATION ORDERING INFORMATION

**LITERATURE FULFILLMENT:**  
Literature Distribution Center for ON Semiconductor  
19521 E. 32nd Pkwy, Aurora, Colorado 80011 USA  
**Phone:** 303-675-2175 or 800-344-3860 Toll Free USA/Canada  
**Fax:** 303-675-2176 or 800-344-3867 Toll Free USA/Canada  
**Email:** [orderlit@onsemi.com](mailto:orderlit@onsemi.com)

**N. American Technical Support:** 800-282-9855 Toll Free  
USA/Canada  
**Europe, Middle East and Africa Technical Support:**  
Phone: 421 33 790 2910  
**Japan Customer Focus Center**  
Phone: 81-3-5817-1050

**ON Semiconductor Website:** [www.onsemi.com](http://www.onsemi.com)  
**Order Literature:** <http://www.onsemi.com/orderlit>  
For additional information, please contact your local Sales Representative