

MUR120 Series

SWITCHMODE Power Rectifiers

MUR105, MUR110, MUR115, MUR120,
MUR130, MUR140, MUR160

The MUR120 series of SWITCHMODE power rectifiers are designed for use in switching power supplies, inverters and as free wheeling diodes.

Features

- Ultrafast 25, 50 and 75 Nanosecond Recovery Times
- 175°C Operating Junction Temperature
- Low Forward Voltage
- Low Leakage Current
- High Temperature Glass Passivated Junction
- Reverse Voltage to 600 V
- Shipped in Plastic Bags; 1,000 per Bag
- Available Tape and Reel; 5,000 per Reel, by adding a "RL" Suffix to the Part Number
- These are Pb-Free Devices*

Mechanical Characteristics:

- Case: Epoxy, Molded
- Weight: 0.4 Gram (Approximately)
- Finish: All External Surfaces Corrosion Resistant and Terminal Leads are Readily Solderable
- Lead Temperature for Soldering Purposes: 260°C Max. for 10 Seconds
- Polarity: Cathode Indicated by Polarity Band



ON Semiconductor®

<http://onsemi.com>

ULTRAFAST RECTIFIERS
1.0 AMPERE, 50 – 600 VOLTS

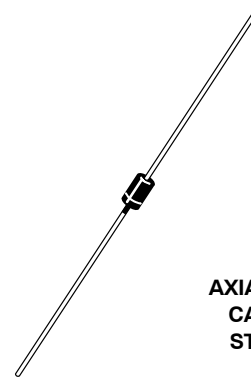

AXIAL LEAD
CASE 59
STYLE 1

MARKING DIAGRAM

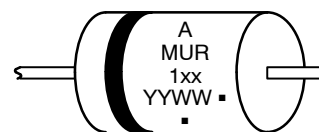

A = Assembly Location
MUR1xx = Specific Device Code
Y = Year
WW = Work Week
▪ = Pb-Free Package

(Note: Microdot may be in either location)

ORDERING INFORMATION

See detailed ordering and shipping information in the package dimensions section on page 6 of this data sheet.

*For additional information on our Pb-Free strategy and soldering details, please download the ON Semiconductor Soldering and Mounting Techniques Reference Manual, SOLDERRM/D.

MUR120 Series

MAXIMUM RATINGS

Rating	Symbol	MUR							Unit
		105	110	115	120	130	140	160	
Peak Repetitive Reverse Voltage Working Peak Reverse Voltage DC Blocking Voltage	V_{RRM} V_{RWM} V_R	50	100	150	200	300	400	600	V
Average Rectified Forward Current (Square Wave Mounting Method #3 Per Note 2)	$I_{F(AV)}$	1.0 @ $T_A = 130^\circ\text{C}$				1.0 @ $T_A = 120^\circ\text{C}$			A
Nonrepetitive Peak Surge Current (Surge applied at rated load conditions, halfwave, single phase, 60 Hz)	I_{FSM}	35							A
Operating Junction Temperature and Storage Temperature	T_J, T_{stg}	- 65 to +175							$^\circ\text{C}$

Stresses exceeding Maximum Ratings may damage the device. Maximum Ratings are stress ratings only. Functional operation above the Recommended Operating Conditions is not implied. Extended exposure to stresses above the Recommended Operating Conditions may affect device reliability.

THERMAL CHARACTERISTICS

Characteristic	Symbol	Max	Unit
Maximum Thermal Resistance, Junction-to-Ambient	$R_{\theta JA}$	Note 2	$^\circ\text{C}/\text{W}$

ELECTRICAL CHARACTERISTICS

Characteristic	Symbol	Value		Unit
Maximum Instantaneous Forward Voltage (Note 1) ($I_F = 1.0$ Amp, $T_J = 150^\circ\text{C}$) ($I_F = 1.0$ Amp, $T_J = 25^\circ\text{C}$)	V_F	0.710 0.875	1.05 1.25	V
Maximum Instantaneous Reverse Current (Note 1) (Rated DC Voltage, $T_J = 150^\circ\text{C}$) (Rated DC Voltage, $T_J = 25^\circ\text{C}$)	i_R	50 2.0	150 5.0	μA
Maximum Reverse Recovery Time ($I_F = 1.0$ A, $di/dt = 50$ A/ μs) ($I_F = 0.5$ A, $i_R = 1.0$ A, $I_{REC} = 0.25$ A)	t_{rr}	35 25	75 50	ns
Maximum Forward Recovery Time ($I_F = 1.0$ A, $di/dt = 100$ A/ μs , I_{REC} to 1.0 V)	t_{fr}	25	50	ns
Typical Peak Reverse Recovery Current ($I_F = 1.0$ A, $di/dt = 50$ A/ μs)	I_{RM}	0.85		A

1. Pulse Test: Pulse Width = 300 μs , Duty Cycle $\leq 2.0\%$.

MUR120 Series

MUR105, MUR110, MUR115, MUR120

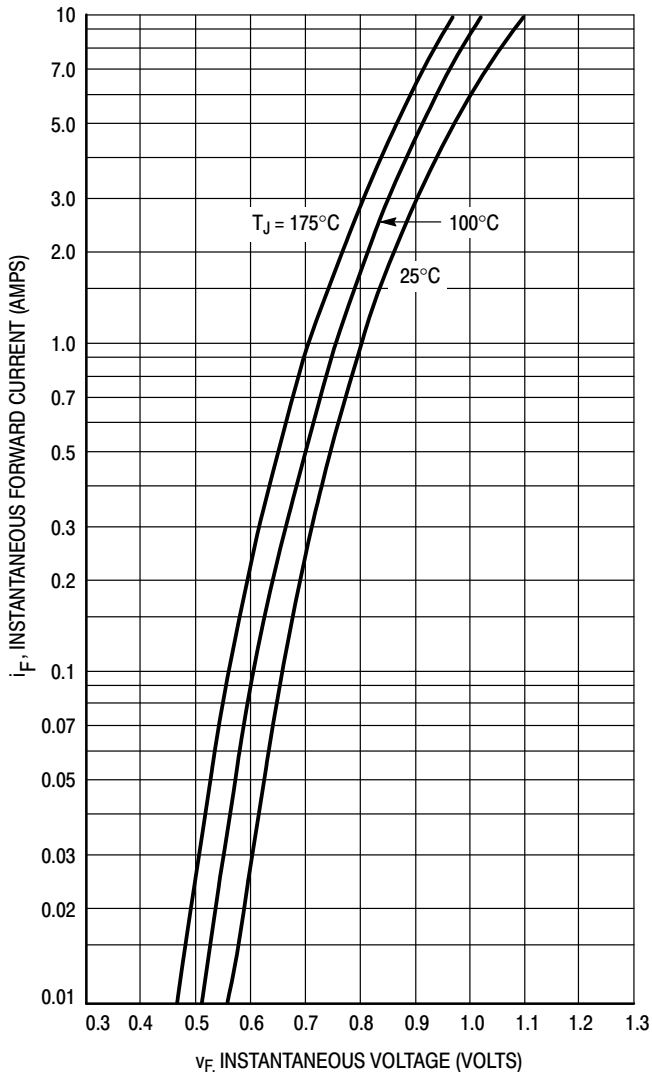

Figure 1. Typical Forward Voltage

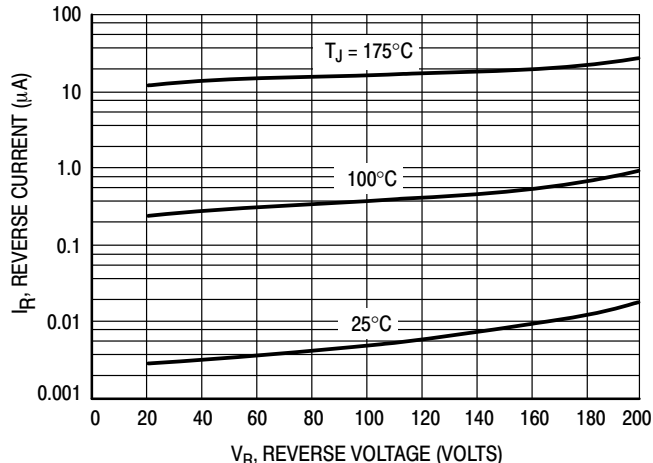
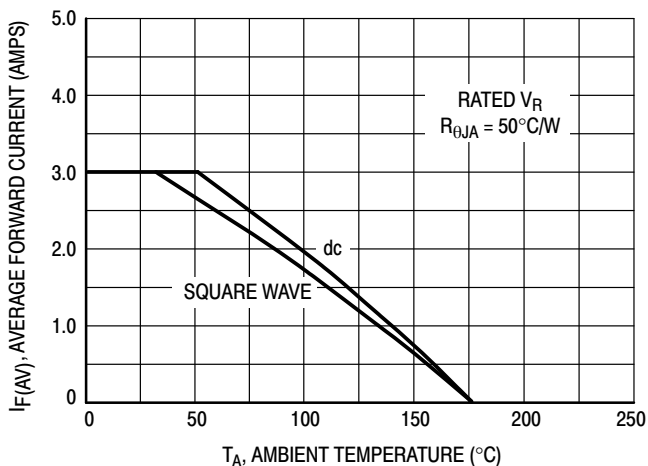

Figure 2. Typical Reverse Current*

* The curves shown are typical for the highest voltage device in the voltage grouping. Typical reverse current for lower voltage selections can be estimated from these same curves if V_R is sufficiently below rated V_R .



**Figure 3. Current Derating
(Mounting Method #3 Per Note 1)**

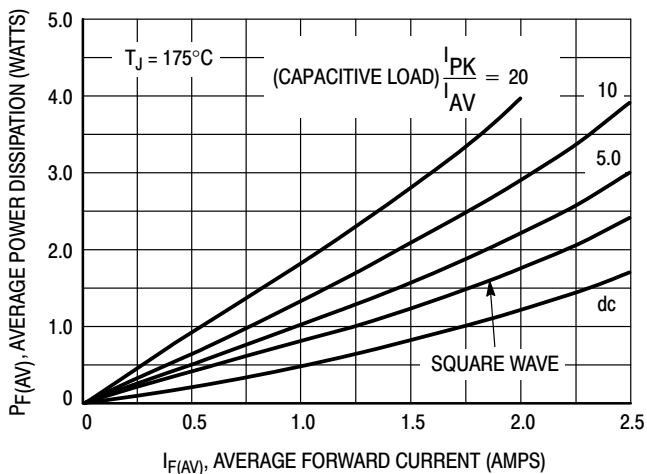

Figure 4. Power Dissipation

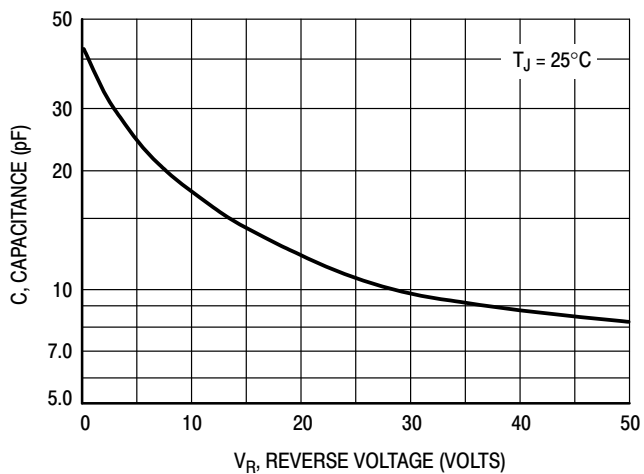

Figure 5. Typical Capacitance

MUR120 Series

MUR130, MUR140, MUR160

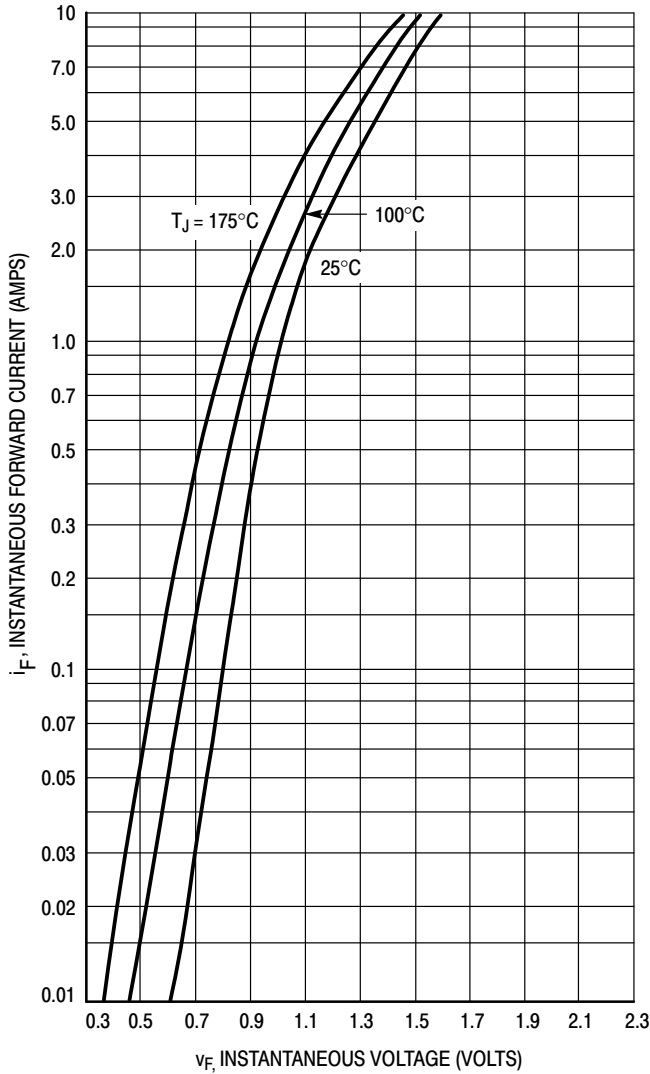

Figure 6. Typical Forward Voltage

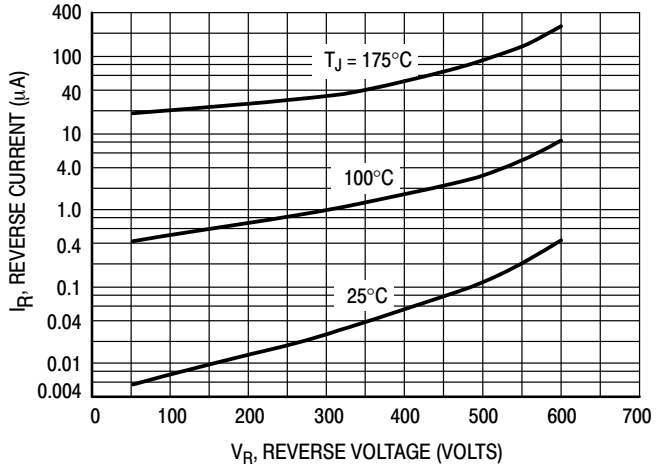
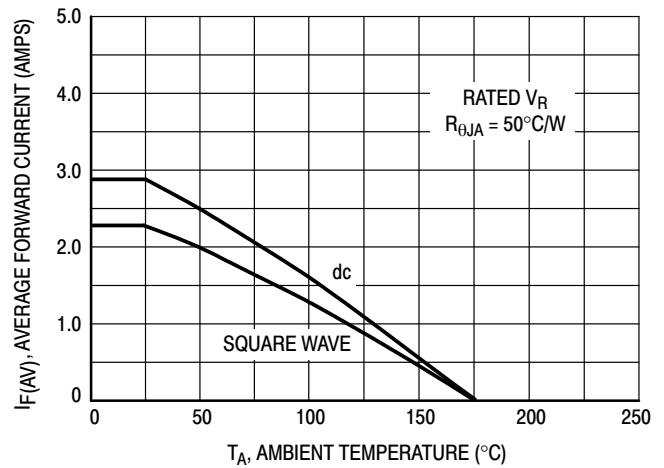

Figure 7. Typical Reverse Current*

* The curves shown are typical for the highest voltage device in the voltage grouping. Typical reverse current for lower voltage selections can be estimated from these same curves if V_R is sufficiently below rated V_R .



**Figure 8. Current Derating
(Mounting Method #3 Per Note 2)**

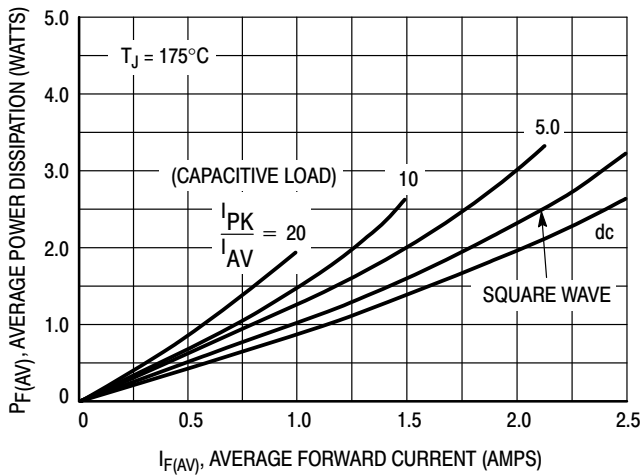

Figure 9. Power Dissipation

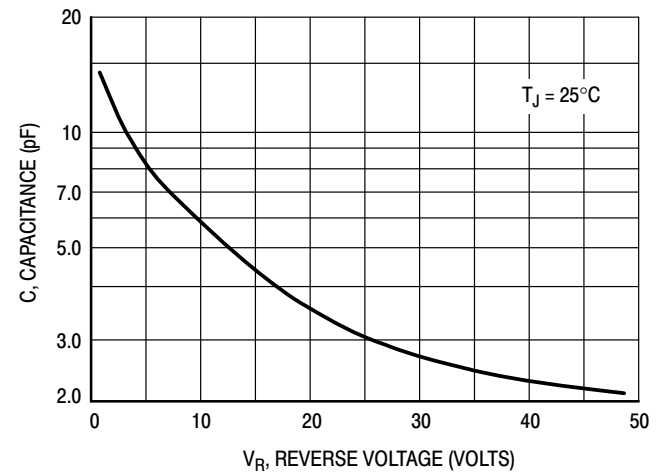

Figure 10. Typical Capacitance

MUR120 Series

NOTE 2. — AMBIENT MOUNTING DATA

Data shown for thermal resistance, junction-to-ambient ($R_{\theta JA}$) for the mountings shown is to be used as typical guideline values for preliminary engineering or in case the tie point temperature cannot be measured.

TYPICAL VALUES FOR $R_{\theta JA}$ IN STILL AIR

Mounting Method	$R_{\theta JA}$	Lead Length, L (in.)			Units
		1/8	1/4	1/2	
1		52	65	72	$^{\circ}\text{C/W}$
2		67	80	87	$^{\circ}\text{C/W}$
3		50			$^{\circ}\text{C/W}$

MOUNTING METHOD 1

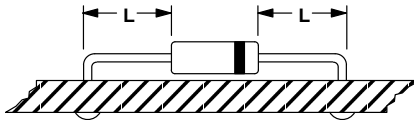

MOUNTING METHOD 2

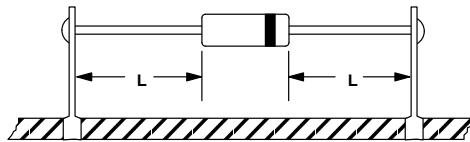

Vector Pin Mounting

MOUNTING METHOD 3

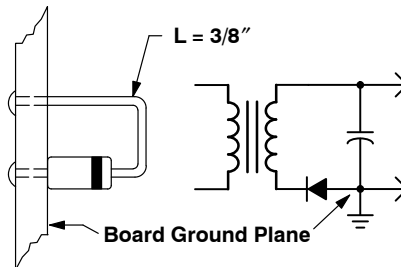

P.C. Board with 1-1/2" X 1-1/2" Copper Surface

MUR120 Series

ORDERING INFORMATION

Device	Marking	Package	Shipping†
MUR105	MUR105	Axial Lead*	1000 Units / Bag
MUR105G	MUR105	Axial Lead*	1000 Units / Bag
MUR105RL	MUR105	Axial Lead*	5000 Units / Tape & Reel
MUR105RLG	MUR105	Axial Lead*	5000 Units / Tape & Reel
MUR110	MUR110	Axial Lead*	1000 Units / Bag
MUR110G	MUR110	Axial Lead*	1000 Units / Bag
MUR110RL	MUR110	Axial Lead*	5000 Units / Tape & Reel
MUR110RLG	MUR110	Axial Lead*	5000 Units / Tape & Reel
MUR115	MUR115	Axial Lead*	1000 Units / Bag
MUR115G	MUR115	Axial Lead*	1000 Units / Bag
MUR115RL	MUR115	Axial Lead*	5000 Units / Tape & Reel
MUR115RLG	MUR115	Axial Lead*	5000 Units / Tape & Reel
MUR120	MUR120	Axial Lead*	1000 Units / Bag
MUR120G	MUR120	Axial Lead*	1000 Units / Bag
MUR120RL	MUR120	Axial Lead*	5000 Units / Tape & Reel
MUR120RLG	MUR120	Axial Lead*	5000 Units / Tape & Reel
MUR130	MUR130	Axial Lead*	1000 Units / Bag
MUR130G	MUR130	Axial Lead*	1000 Units / Bag
MUR130RL	MUR130	Axial Lead*	5000 Units / Tape & Reel
MUR130RLG	MUR130	Axial Lead*	5000 Units / Tape & Reel
MUR140	MUR140	Axial Lead*	1000 Units / Bag
MUR140G	MUR140	Axial Lead*	1000 Units / Bag
MUR140RL	MUR140	Axial Lead*	5000 Units / Tape & Reel
MUR140RLG	MUR140	Axial Lead*	5000 Units / Tape & Reel
MUR160	MUR160	Axial Lead*	1000 Units / Bag
MUR160G	MUR160	Axial Lead*	1000 Units / Bag
MUR160RL	MUR160	Axial Lead*	5000 Units / Tape & Reel
MUR160RLG	MUR160	Axial Lead*	5000 Units / Tape & Reel

†For information on tape and reel specifications, including part orientation and tape sizes, please refer to our Tape and Reel Packaging Specifications Brochure, BRD8011/D.

*This package is inherently Pb-Free.

MECHANICAL CASE OUTLINE

PACKAGE DIMENSIONS

ON Semiconductor®



AXIAL LEAD CASE 59-10 ISSUE U

DATE 15 FEB 2005

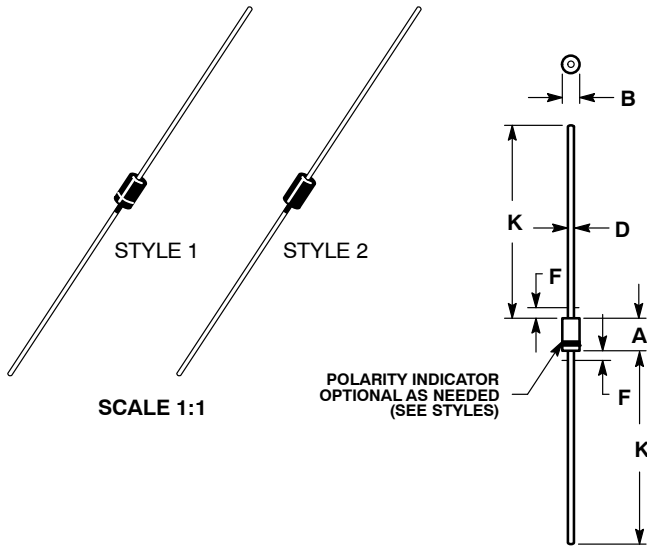

STYLE 1

STYLE 2

SCALE 1:1

POLARITY INDICATOR
OPTIONAL AS NEEDED
(SEE STYLES)

NOTES:

1. DIMENSIONING AND TOLERANCING PER ANSI Y14.5M, 1982.
2. CONTROLLING DIMENSION: INCH.
3. ALL RULES AND NOTES ASSOCIATED WITH JEDEC DO-41 OUTLINE SHALL APPLY.
4. POLARITY DENOTED BY CATHODE BAND.
5. LEAD DIAMETER NOT CONTROLLED WITHIN F DIMENSION.

DIM	INCHES		MILLIMETERS	
	MIN	MAX	MIN	MAX
A	0.161	0.205	4.10	5.20
B	0.079	0.106	2.00	2.70
D	0.028	0.034	0.71	0.86
F	---	0.050	---	1.27
K	1.000	---	25.40	---

GENERIC MARKING DIAGRAM*

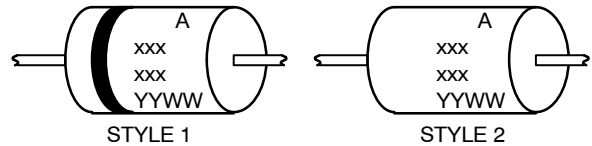

STYLE 1:
PIN 1. CATHODE (POLARITY BAND)
2. ANODE

STYLE 2:
NO POLARITY

- xxx = Specific Device Code
- A = Assembly Location
- YY = Year
- WW = Work Week

*This information is generic. Please refer to device data sheet for actual part marking.
Pb-Free indicator, "G" or microdot "▪", may or may not be present.

DOCUMENT NUMBER:	98ASB42045B	Electronic versions are uncontrolled except when accessed directly from the Document Repository. Printed versions are uncontrolled except when stamped "CONTROLLED COPY" in red.
DESCRIPTION:	AXIAL LEAD	PAGE 1 OF 1

ON Semiconductor and are trademarks of Semiconductor Components Industries, LLC dba ON Semiconductor or its subsidiaries in the United States and/or other countries. ON Semiconductor reserves the right to make changes without further notice to any products herein. ON Semiconductor makes no warranty, representation or guarantee regarding the suitability of its products for any particular purpose, nor does ON Semiconductor assume any liability arising out of the application or use of any product or circuit, and specifically disclaims any and all liability, including without limitation special, consequential or incidental damages. ON Semiconductor does not convey any license under its patent rights nor the rights of others.

onsemi, **Onsemi**, and other names, marks, and brands are registered and/or common law trademarks of Semiconductor Components Industries, LLC dba "**onsemi**" or its affiliates and/or subsidiaries in the United States and/or other countries. **onsemi** owns the rights to a number of patents, trademarks, copyrights, trade secrets, and other intellectual property. A listing of **onsemi**'s product/patent coverage may be accessed at www.onsemi.com/site/pdf/Patent-Marking.pdf. **onsemi** reserves the right to make changes at any time to any products or information herein, without notice. The information herein is provided "as-is" and **onsemi** makes no warranty, representation or guarantee regarding the accuracy of the information, product features, availability, functionality, or suitability of its products for any particular purpose, nor does **onsemi** assume any liability arising out of the application or use of any product or circuit, and specifically disclaims any and all liability, including without limitation special, consequential or incidental damages. Buyer is responsible for its products and applications using **onsemi** products, including compliance with all laws, regulations and safety requirements or standards, regardless of any support or applications information provided by **onsemi**. "Typical" parameters which may be provided in **onsemi** data sheets and/or specifications can and do vary in different applications and actual performance may vary over time. All operating parameters, including "Typicals" must be validated for each customer application by customer's technical experts. **onsemi** does not convey any license under any of its intellectual property rights nor the rights of others. **onsemi** products are not designed, intended, or authorized for use as a critical component in life support systems or any FDA Class 3 medical devices or medical devices with a same or similar classification in a foreign jurisdiction or any devices intended for implantation in the human body. Should Buyer purchase or use **onsemi** products for any such unintended or unauthorized application, Buyer shall indemnify and hold **onsemi** and its officers, employees, subsidiaries, affiliates, and distributors harmless against all claims, costs, damages, and expenses, and reasonable attorney fees arising out of, directly or indirectly, any claim of personal injury or death associated with such unintended or unauthorized use, even if such claim alleges that **onsemi** was negligent regarding the design or manufacture of the part. **onsemi** is an Equal Opportunity/Affirmative Action Employer. This literature is subject to all applicable copyright laws and is not for resale in any manner.

PUBLICATION ORDERING INFORMATION

LITERATURE FULFILLMENT:

Email Requests to: orderlit@onsemi.com

onsemi Website: www.onsemi.com

TECHNICAL SUPPORT

North American Technical Support:

Voice Mail: 1 800-282-9855 Toll Free USA/Canada

Phone: 011 421 33 790 2910

Europe, Middle East and Africa Technical Support:

Phone: 00421 33 790 2910

For additional information, please contact your local Sales Representative

