

MURS120T3G Series, SURS8120T3G Series, NRVUS120VT3G Series

Surface Mount Ultrafast Power Rectifiers

MURS105T3G, MURS110T3G, MURS115T3G,
MURS120T3G, MURS140T3G, MURS160T3G,
SURS8105T3G, SURS8110T3G, SURS8115T3G,
SURS8120T3G, SURS8140T3G, SURS8160T3G,
NRVUS110VT3G, NRVUS120VT3G,
NRVUS160VT3G

Ideally suited for high voltage, high frequency rectification, or as free wheeling and protection diodes in surface mount applications where compact size and weight are critical to the system.

Features

- Small Compact Surface Mountable Package with J-Bend Leads
- Rectangular Package for Automated Handling
- High Temperature Glass Passivated Junction
- Low Forward Voltage Drop (0.71 to 1.05 V Max @ 1.0 A, $T_J = 150^{\circ}\text{C}$)
- NRVUS and SURS8 Prefixes for Automotive and Other Applications Requiring Unique Site and Control Change Requirements; AEC-Q101 Qualified and PPAP Capable
- These Devices are Pb-Free and are RoHS Compliant

Mechanical Characteristics:

- Case: Epoxy, Molded
- Weight: 95 mg (Approximately)
- Finish: All External Surfaces Corrosion Resistant and Terminal Leads are Readily Solderable
- Lead and Mounting Surface Temperature for Soldering Purposes: 260°C Max. for 10 Seconds
- Polarity: Polarity Band Indicates Cathode Lead
- ESD Rating:
 - ◆ Human Body Model = 3B (> 8 kV)
 - ◆ Machine Model = C (> 400 V)



ON Semiconductor®

www.onsemi.com

ULTRAFAST RECTIFIERS
1.0 AMPERE, 50–600 VOLTS



SMB
CASE 403A

MARKING DIAGRAM

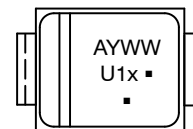

A = Assembly Location*
Y = Year
WW = Work Week
U1 = Device Code
x = A, B, C, D, G, or J
▪ = Pb-Free Package

(Note: Microdot may be in either location)

* The Assembly Location code (A) is front side optional. In cases where the Assembly Location is stamped in the package bottom (molding ejector pin), the front side assembly code may be blank.

ORDERING INFORMATION

See detailed ordering and shipping information in the table on page 2 of this data sheet.

DEVICE MARKING INFORMATION

See general marking information in the device marking table on page 2 of this data sheet.

MURS120T3G Series, SURS8120T3G Series, NRVUS120VT3G Series

MAXIMUM RATINGS

Rating	Symbol	MURS/SURS8/NRVUS						Unit
		105T3	110T3	115T3	120T3	140T3	160T3	
Peak Repetitive Reverse Voltage Working Peak Reverse Voltage DC Blocking Voltage	V_{RRM} V_{RWM} V_R	50	100	150	200	400	600	V
Average Rectified Forward Current	$I_{F(AV)}$	1.0 @ $T_L = 155^\circ\text{C}$ 2.0 @ $T_L = 145^\circ\text{C}$			1.0 @ $T_L = 150^\circ\text{C}$ 2.0 @ $T_L = 125^\circ\text{C}$			A
Non-Repetitive Peak Surge Current, (Surge applied at rated load conditions halfwave, single phase, 60 Hz)	I_{FSM}	40			35			A
Operating Junction Temperature	T_J	- 65 to +175						$^\circ\text{C}$

Stresses exceeding those listed in the Maximum Ratings table may damage the device. If any of these limits are exceeded, device functionality should not be assumed, damage may occur and reliability may be affected.

THERMAL CHARACTERISTICS

Rating	Symbol	MURS/SURS8/NRVUS						Unit
		105T3	110T3	115T3	120T3	140T3	160T3	
Thermal Resistance Junction-to-Lead ($T_L = 25^\circ\text{C}$)	$R_{\theta JL}$	13						$^\circ\text{C}/\text{W}$

ELECTRICAL CHARACTERISTICS ($T_A = 25^\circ\text{C}$, Unless otherwise noted)

Maximum Instantaneous Forward Voltage (Note 1) ($i_F = 1.0\text{ A}$, $T_J = 25^\circ\text{C}$) ($i_F = 1.0\text{ A}$, $T_J = 150^\circ\text{C}$)	v_F	0.875 0.71			1.25 1.05		V
Maximum Instantaneous Reverse Current (Note 1) (Rated DC Voltage, $T_J = 25^\circ\text{C}$) (Rated DC Voltage, $T_J = 150^\circ\text{C}$)	i_R	2.0 50			5.0 150		μA
Maximum Reverse Recovery Time ($i_F = 1.0\text{ A}$, $di/dt = 50\text{ A}/\mu\text{s}$, $V_R = 30\text{ V}$) ($i_F = 0.5\text{ A}$, $i_R = 1.0\text{ A}$, I_R to 0.25 A)	t_{rr}	35 25			75 50		ns
Maximum Forward Recovery Time ($i_F = 1.0\text{ A}$, $di/dt = 100\text{ A}/\mu\text{s}$, Rec. to 1.0 V)	t_{fr}	25			50		ns
Typical Peak Reverse Recovery Current ($i_F = 1.0\text{ A}$, $di/dt = 50\text{ A}/\mu\text{s}$)	I_{RM}	0.75			1.60		A

1. Pulse Test: Pulse Width = 300 μs , Duty Cycle $\leq 2.0\%$.

DEVICE MARKING AND ORDERING INFORMATION

Device	Marking	Package	Shipping [†]
MURS105T3G, SURS8105T3G*	U1A	SMB (Pb-Free)	2,500 Units / Tape & Reel
MURS110T3G, NRVUS110VT3G* SURS8110T3G*	U1B	SMB (Pb-Free)	2,500 Units / Tape & Reel
MURS115T3G, SURS8115T3G*	U1C	SMB (Pb-Free)	2,500 Units / Tape & Reel
MURS120T3G, NRVUS120VT3G* SURS8120T3G*	U1D	SMB (Pb-Free)	2,500 Units / Tape & Reel
MURS140T3G, SURS8140T3G*	U1G	SMB (Pb-Free)	2,500 Units / Tape & Reel
MURS160T3G, NRVUS160VT3G* SURS8160T3G*	U1J	SMB (Pb-Free)	2,500 Units / Tape & Reel

[†]For information on tape and reel specifications, including part orientation and tape sizes, please refer to our Tape and Reel Packaging Specifications Brochure, BRD8011/D.

*NRVUS and SURS8 Prefixes for Automotive and Other Applications Requiring Unique Site and Control Change Requirements; AEC-Q101 Qualified and PPAP Capable.

MURS120T3G Series, SURS8120T3G Series, NRVUS120VT3G Series

MURS105T3G, MURS110T3G, MURS115T3G, MURS120T3G,
SURS8105T3G, SURS8110T3G, SURS8115T3G, SURS8120T3G, NRVUS110VT3G, NRVUS120VT3G

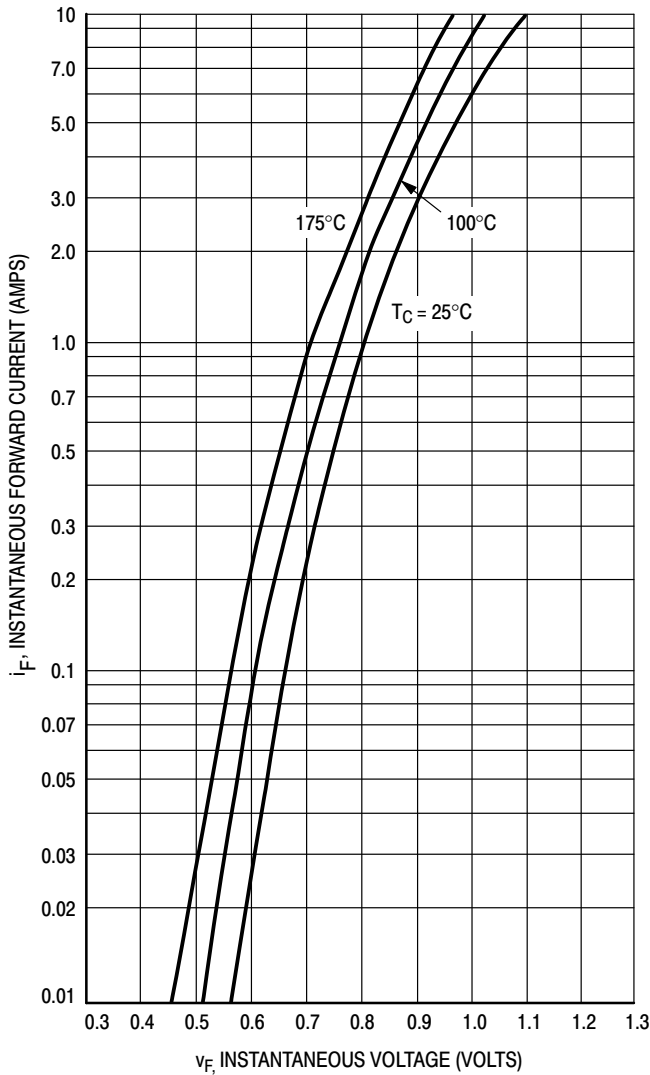

Figure 1. Typical Forward Voltage

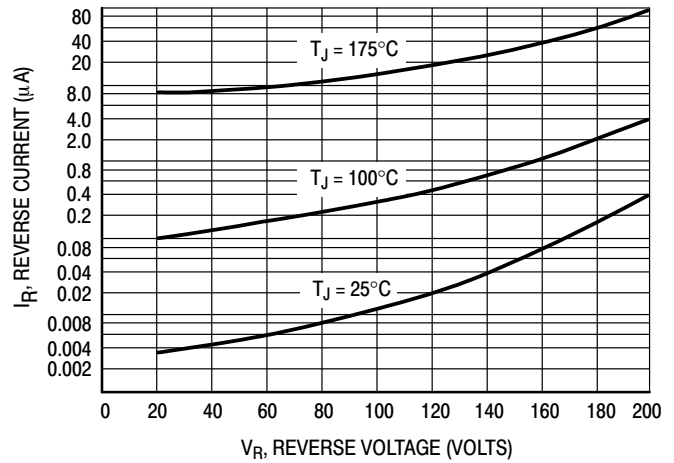

Figure 2. Typical Reverse Current*

*The curves shown are typical for the highest voltage device in the voltage grouping. Typical reverse current for lower voltage selections can be estimated from these same curves if applied V_R is sufficiently below rated V_R .

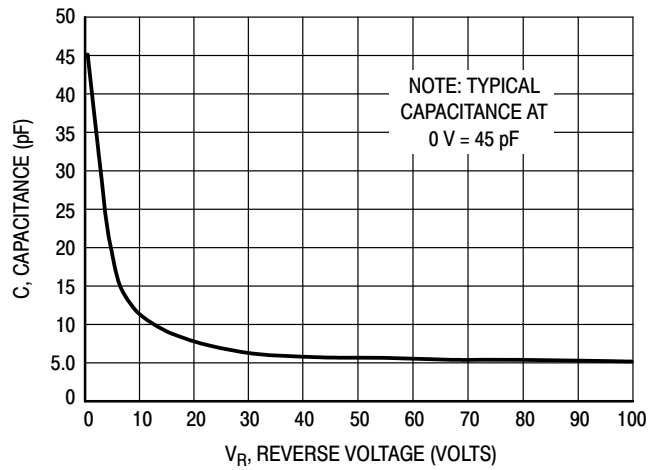

Figure 3. Typical Capacitance

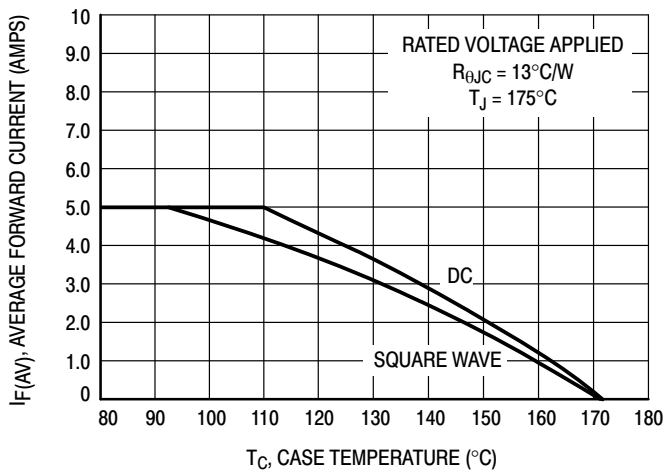

Figure 4. Current Derating, Case

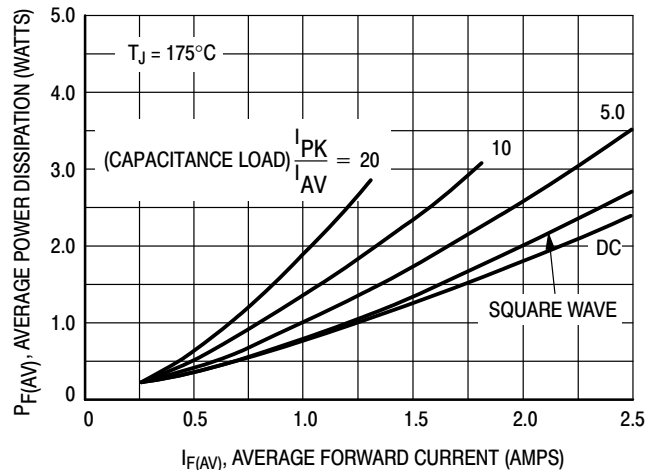

Figure 5. Power Dissipation

MURS120T3G Series, SURS8120T3G Series, NRVUS120VT3G Series

MURS140T3G, MURS160T3G, SURS8140T3G, SURS8160T3G, NRVUS160VT3G

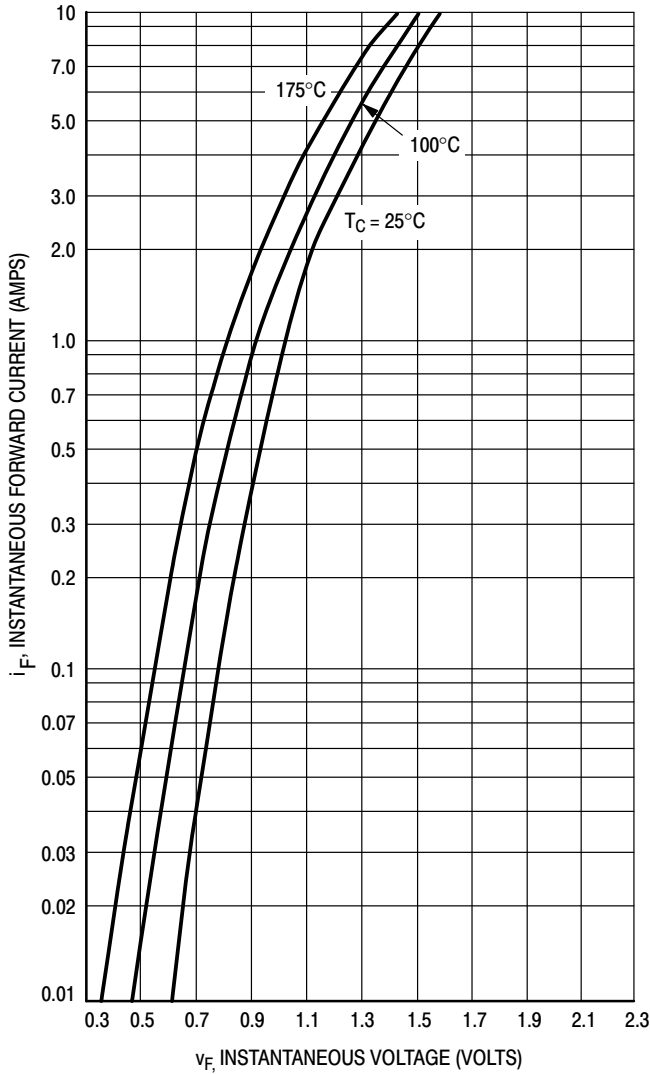

Figure 6. Typical Forward Voltage

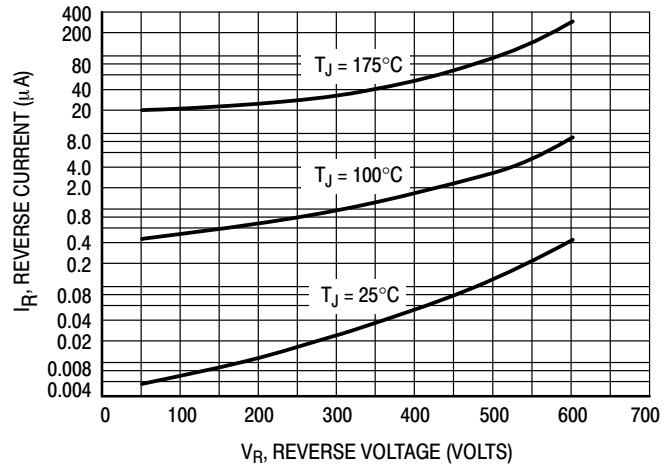

Figure 7. Typical Reverse Current*

*The curves shown are typical for the highest voltage device in the voltage grouping. Typical reverse current for lower voltage selections can be estimated from these same curves if applied V_R is sufficiently below rated V_R .

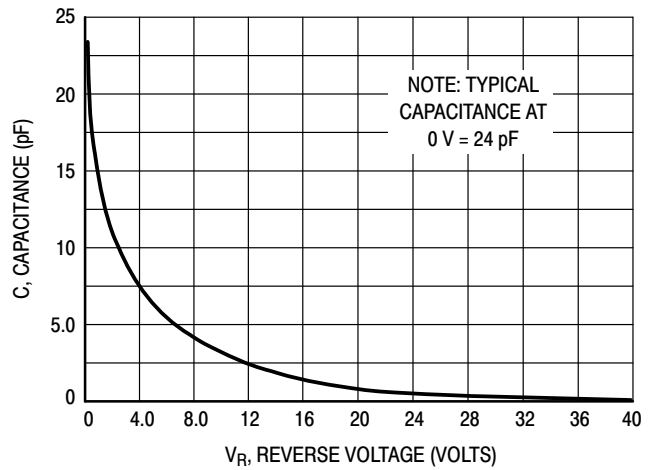

Figure 8. Typical Capacitance

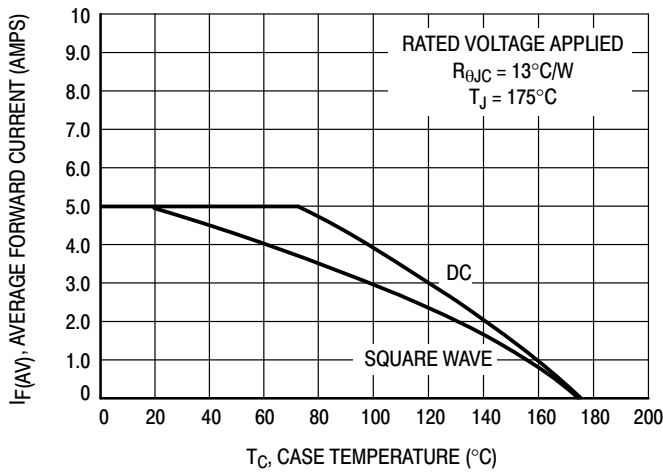

Figure 9. Current Derating, Case

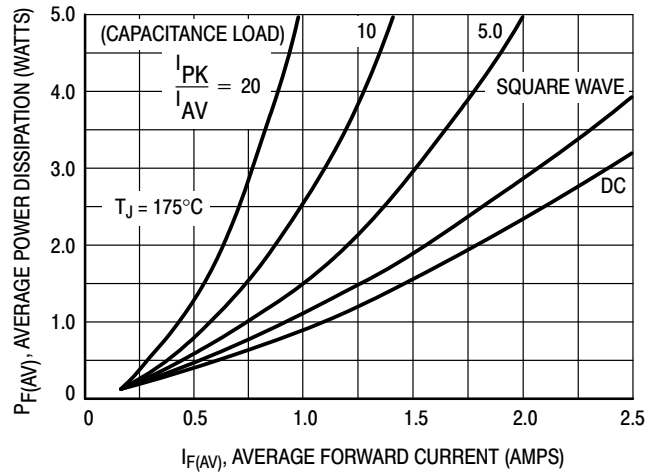

Figure 10. Power Dissipation

MECHANICAL CASE OUTLINE

PACKAGE DIMENSIONS

ON Semiconductor®



SCALE 1:1

Polarity Band



SCALE 1:1

Non-Polarity Band

SMB
CASE 403A-03
ISSUE J

DATE 19 JUL 2012

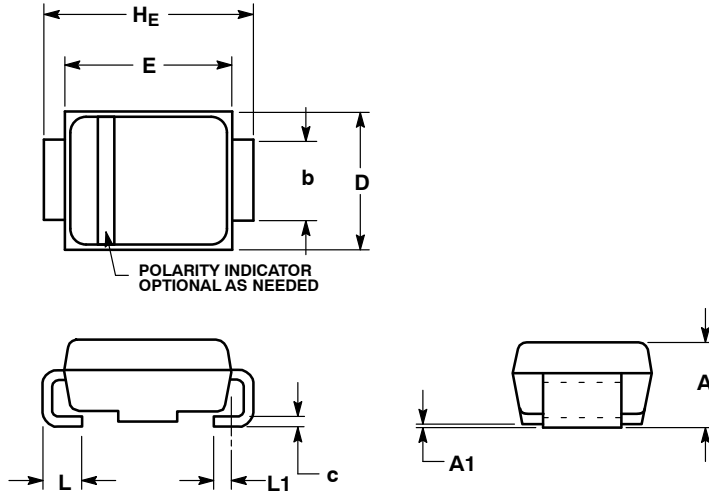

SOLDERING FOOTPRINT*



- NOTES:
1. DIMENSIONING AND TOLERANCING PER ANSI Y14.5M, 1982.
 2. CONTROLLING DIMENSION: INCH.
 3. DIMENSION b SHALL BE MEASURED WITHIN DIMENSION L1.

DIM	MILLIMETERS			INCHES		
	MIN	NOM	MAX	MIN	NOM	MAX
A	1.95	2.30	2.47	0.077	0.091	0.097
A1	0.05	0.10	0.20	0.002	0.004	0.008
b	1.96	2.03	2.20	0.077	0.080	0.087
c	0.15	0.23	0.31	0.006	0.009	0.012
D	3.30	3.56	3.95	0.130	0.140	0.156
E	4.06	4.32	4.60	0.160	0.170	0.181
HE	5.21	5.44	5.60	0.205	0.214	0.220
L	0.76	1.02	1.60	0.030	0.040	0.063
L1	0.51 REF			0.020 REF		

GENERIC MARKING DIAGRAM*

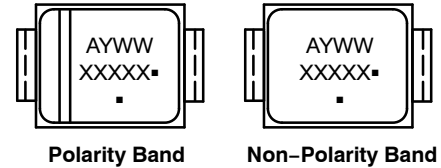

- XXXXX = Specific Device Code
 - A = Assembly Location
 - Y = Year
 - WW = Work Week
 - = Pb-Free Package
- (Note: Microdot may be in either location)

*This information is generic. Please refer to device data sheet for actual part marking. Pb-Free indicator, "G" or microdot "▪", may or may not be present.

*For additional information on our Pb-Free strategy and soldering details, please download the ON Semiconductor Soldering and Mounting Techniques Reference Manual, SOLDERRM/D.

DOCUMENT NUMBER:	98ASB42669B	Electronic versions are uncontrolled except when accessed directly from the Document Repository. Printed versions are uncontrolled except when stamped "CONTROLLED COPY" in red.
DESCRIPTION:	SMB	PAGE 1 OF 1

ON Semiconductor and are trademarks of Semiconductor Components Industries, LLC dba ON Semiconductor or its subsidiaries in the United States and/or other countries. ON Semiconductor reserves the right to make changes without further notice to any products herein. ON Semiconductor makes no warranty, representation or guarantee regarding the suitability of its products for any particular purpose, nor does ON Semiconductor assume any liability arising out of the application or use of any product or circuit, and specifically disclaims any and all liability, including without limitation special, consequential or incidental damages. ON Semiconductor does not convey any license under its patent rights nor the rights of others.

onsemi, **Onsemi**, and other names, marks, and brands are registered and/or common law trademarks of Semiconductor Components Industries, LLC dba "**onsemi**" or its affiliates and/or subsidiaries in the United States and/or other countries. **onsemi** owns the rights to a number of patents, trademarks, copyrights, trade secrets, and other intellectual property. A listing of **onsemi**'s product/patent coverage may be accessed at www.onsemi.com/site/pdf/Patent-Marking.pdf. **onsemi** reserves the right to make changes at any time to any products or information herein, without notice. The information herein is provided "as-is" and **onsemi** makes no warranty, representation or guarantee regarding the accuracy of the information, product features, availability, functionality, or suitability of its products for any particular purpose, nor does **onsemi** assume any liability arising out of the application or use of any product or circuit, and specifically disclaims any and all liability, including without limitation special, consequential or incidental damages. Buyer is responsible for its products and applications using **onsemi** products, including compliance with all laws, regulations and safety requirements or standards, regardless of any support or applications information provided by **onsemi**. "Typical" parameters which may be provided in **onsemi** data sheets and/or specifications can and do vary in different applications and actual performance may vary over time. All operating parameters, including "Typicals" must be validated for each customer application by customer's technical experts. **onsemi** does not convey any license under any of its intellectual property rights nor the rights of others. **onsemi** products are not designed, intended, or authorized for use as a critical component in life support systems or any FDA Class 3 medical devices or medical devices with a same or similar classification in a foreign jurisdiction or any devices intended for implantation in the human body. Should Buyer purchase or use **onsemi** products for any such unintended or unauthorized application, Buyer shall indemnify and hold **onsemi** and its officers, employees, subsidiaries, affiliates, and distributors harmless against all claims, costs, damages, and expenses, and reasonable attorney fees arising out of, directly or indirectly, any claim of personal injury or death associated with such unintended or unauthorized use, even if such claim alleges that **onsemi** was negligent regarding the design or manufacture of the part. **onsemi** is an Equal Opportunity/Affirmative Action Employer. This literature is subject to all applicable copyright laws and is not for resale in any manner.

PUBLICATION ORDERING INFORMATION

LITERATURE FULFILLMENT:

Email Requests to: orderlit@onsemi.com

onsemi Website: www.onsemi.com

TECHNICAL SUPPORT

North American Technical Support:

Voice Mail: 1 800-282-9855 Toll Free USA/Canada

Phone: 011 421 33 790 2910

Europe, Middle East and Africa Technical Support:

Phone: 00421 33 790 2910

For additional information, please contact your local Sales Representative

