

MBRM2H100T3G, NRVBM2H100T3G

Surface Mount Schottky Power Rectifier

POWERMITE® Power Surface Mount Package

The Schottky Powermite® employs the Schottky Barrier principle with a barrier metal and epitaxial construction that produces optimal forward voltage drop–reverse current tradeoff. The advanced packaging techniques provide for a highly efficient micro miniature, space saving surface mount Rectifier. With its unique heatsink design, the Powermite® has the same thermal performance as the SMA while being 50% smaller in footprint area. Because of its small size, it is ideal for use in portable and battery powered products such as cellular and cordless phones, chargers, notebook computers, printers, PDAs and PCMCIA cards. Typical applications are AC–DC and DC–DC converters, reverse battery protection, and “ORing” of multiple supply voltages and any other application where performance and size are critical.

Features

- Low Profile – Maximum Height of 1.1 mm
- Small Footprint – Footprint Area of 8.45 mm²
- Low V_F Provides Higher Efficiency and Extends Battery Life
- Supplied in 12 mm Tape and Reel
- Low Thermal Resistance with Direct Thermal Path of Die on Exposed Cathode Heat Sink
- NRV Prefix for Automotive and Other Applications Requiring Unique Site and Control Change Requirements; AEC–Q101 Qualified and PPAP Capable
- This is a Pb–Free Device

Mechanical Characteristics:

- Powermite® is JEDEC Registered as D0–216AA
- Case: Molded Epoxy
- Epoxy Meets UL 94 V–0 @ 0.125 in
- Weight: 16.3 mg (Approximately)
- Lead and Mounting Surface Temperature for Soldering Purposes: 260°C Maximum for 10 Seconds



ON Semiconductor®

<http://onsemi.com>

SCHOTTKY BARRIER RECTIFIER 2.0 AMPERES, 100 VOLTS

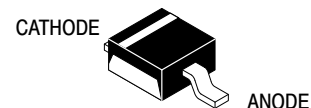

POWERMITE
CASE 457

MARKING DIAGRAM

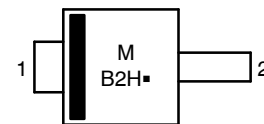

M = Date Code
B2H = Device Code
■ = Pb–Free Package

ORDERING INFORMATION

Device	Package	Shipping†
MBRM2H100T3G	Powermite (Pb–Free)	12000/Tape & Reel
NRVBM2H100T3G	Powermite (Pb–Free)	12000/Tape & Reel

†For information on tape and reel specifications, including part orientation and tape sizes, please refer to our Tape and Reel Packaging Specifications Brochure, BRD8011/D.

MBRM2H100T3G, NRVBM2H100T3G

MAXIMUM RATINGS

Rating	Symbol	Value	Unit
Peak Repetitive Reverse Voltage Working Peak Reverse Voltage DC Blocking Voltage	V_{RRM} V_{RWM} V_R	100	V
Average Rectified Forward Current ($T_L = 160^\circ\text{C}$)	I_O	2.0	A
Non-Repetitive Peak Surge Current (Surge Applied at Rated Load Conditions Halfwave, Single Phase, 60 Hz)	I_{FSM}	50	A
Storage and Operating Junction Temperature Range (Note 1)	T_{stg}, T_J	-65 to +175	$^\circ\text{C}$

Stresses exceeding those listed in the Maximum Ratings table may damage the device. If any of these limits are exceeded, device functionality should not be assumed, damage may occur and reliability may be affected.

- The heat generated must be less than the thermal conductivity from Junction-to-Ambient: $dP_D/dT_J < 1/R_{\theta JA}$.

THERMAL CHARACTERISTICS

Characteristic	Symbol	Value	Unit
Thermal Resistance, Junction-to-Lead (Note 2)	Ψ_{JCL}	12	$^\circ\text{C}/\text{W}$
Thermal Resistance, Junction-to-Ambient (Note 2)	$R_{\theta JA}$	75	$^\circ\text{C}/\text{W}$
Thermal Resistance, Junction-to-Ambient (Note 3)	$R_{\theta JA}$	260	$^\circ\text{C}/\text{W}$

ELECTRICAL CHARACTERISTICS

Characteristic	Symbol	Value	Unit
Maximum Instantaneous Forward Voltage (Note 4) ($I_F = 1.0 \text{ A}, T_J = 25^\circ\text{C}$) ($I_F = 2.0 \text{ A}, T_J = 25^\circ\text{C}$) ($I_F = 1.0 \text{ A}, T_J = 125^\circ\text{C}$) ($I_F = 2.0 \text{ A}, T_J = 125^\circ\text{C}$)	V_F	0.76 0.84 0.61 0.68	V
Maximum Instantaneous Reverse Current (Note 4) (Rated dc Voltage, $T_J = 25^\circ\text{C}$) (Rated dc Voltage, $T_J = 125^\circ\text{C}$)	I_R	20 1.0	μA mA

Product parametric performance is indicated in the Electrical Characteristics for the listed test conditions, unless otherwise noted. Product performance may not be indicated by the Electrical Characteristics if operated under different conditions.

- Mounted with 700 mm² copper pad size (Approximately 1 in²) 1 oz FR4 Board.
- Mounted with pad size approximately 20 mm² copper, 1 oz FR4 Board.
- Pulse Test: Pulse Width $\leq 380 \mu\text{s}$, Duty Cycle $\leq 2.0\%$.

MBRM2H100T3G, NRVBM2H100T3G

TYPICAL CHARACTERISTICS

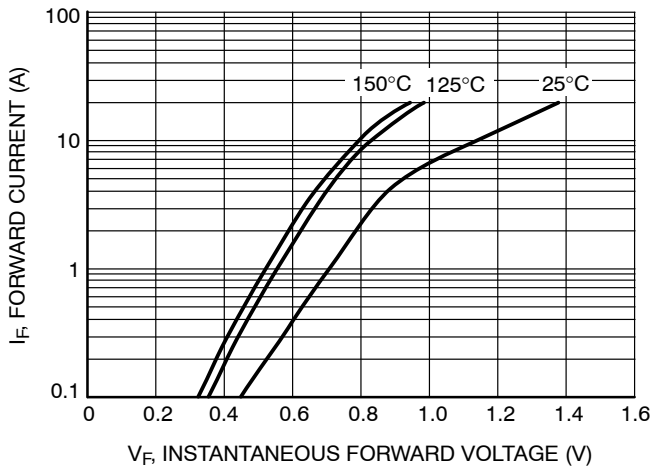

Figure 1. Typical Forward Voltage

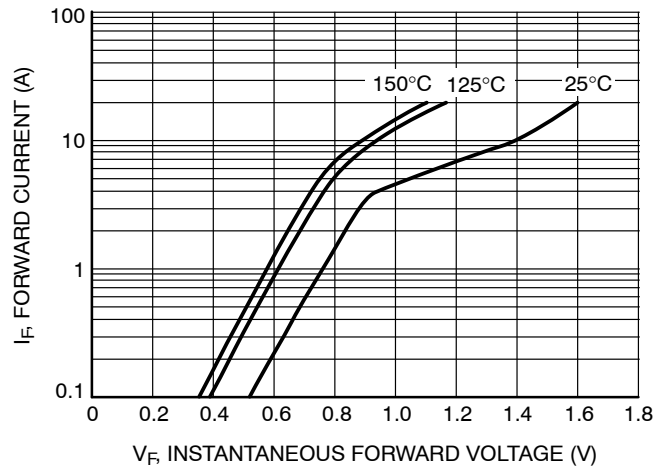

Figure 2. Maximum Forward Voltage

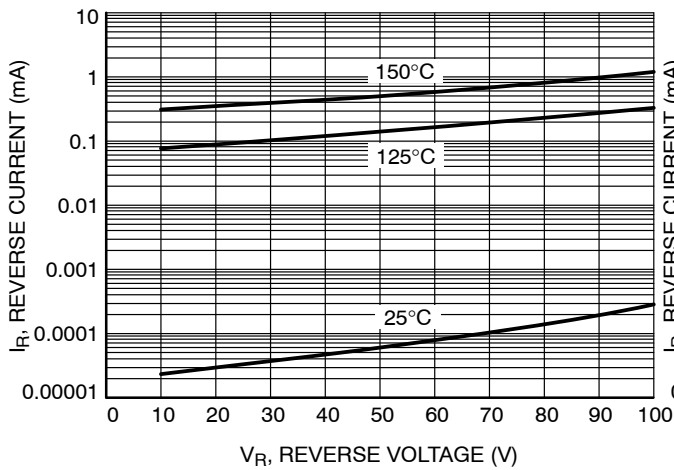

Figure 3. Typical Reverse Current

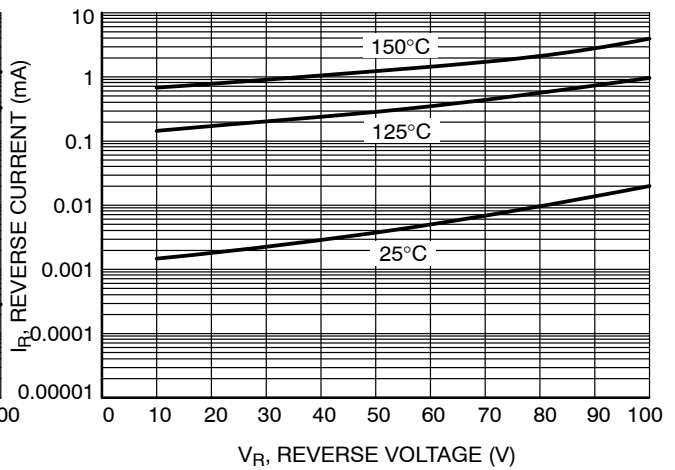

Figure 4. Maximum Reverse Current

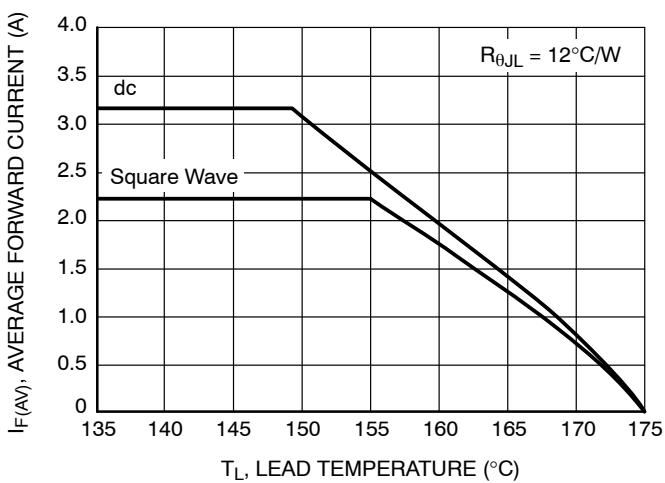

Figure 5. Current Derating

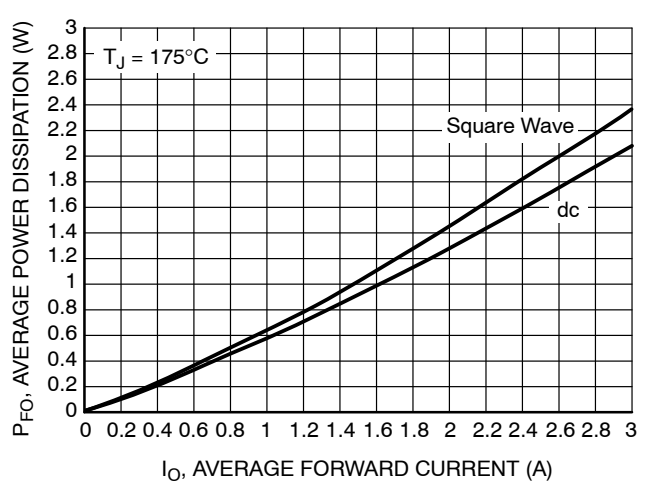

Figure 6. Forward Power Dissipation

MBRM2H100T3G, NRVBM2H100T3G

TYPICAL CHARACTERISTICS

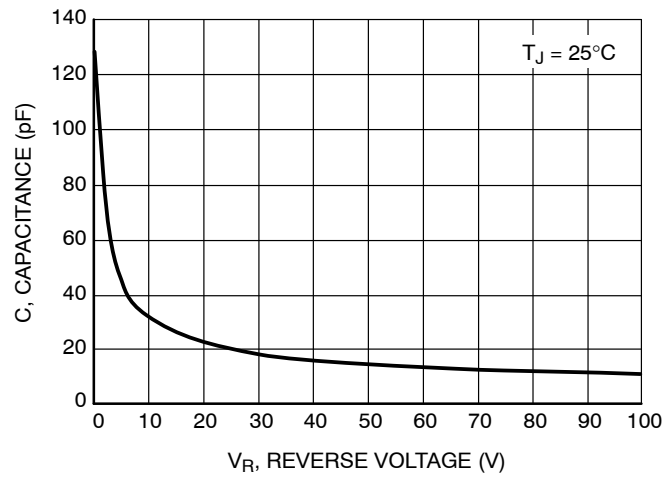

Figure 7. Capacitance

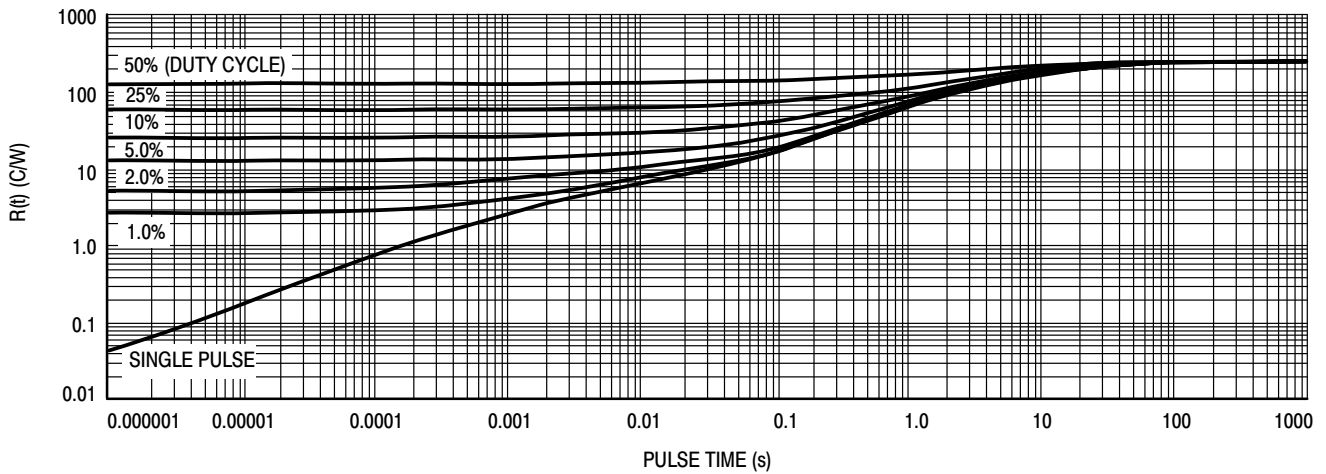

Figure 8. Thermal Response, Junction-to-Ambient (20 mm^2 pad)

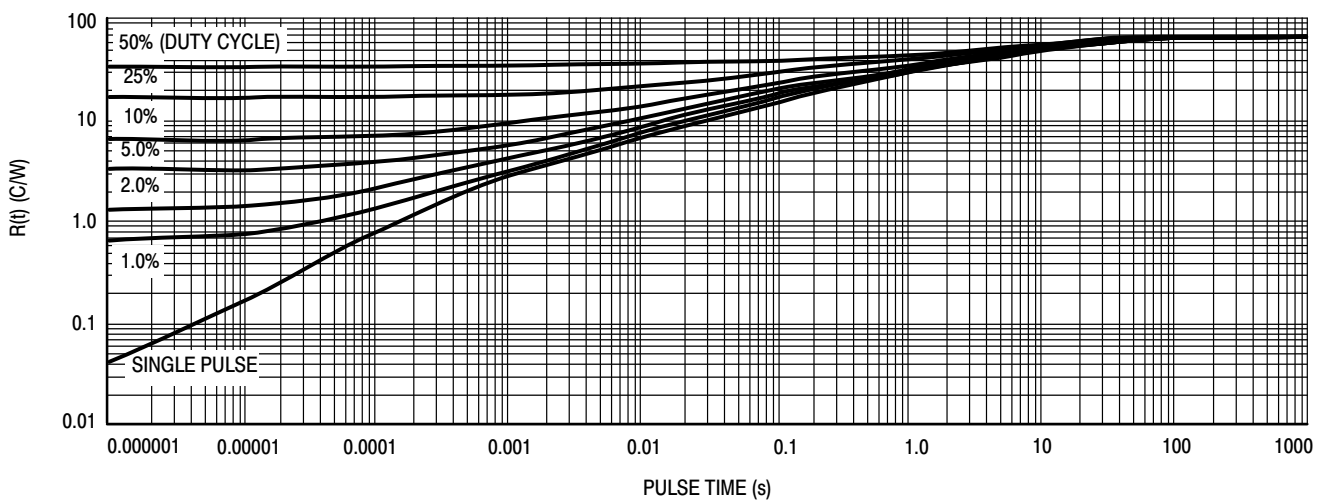
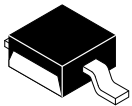

Figure 9. Thermal Response, Junction-to-Ambient (1 in^2 pad)

POWERMITE is a registered trademark of and used under a license from Microsemi Corporation.

MECHANICAL CASE OUTLINE PACKAGE DIMENSIONS



SCALE 4:1

POWERMITE CASE 457 ISSUE G

DATE 12 JAN 2022



RECOMMENDED
MOUNTING FOOTPRINT

DIM	MILLIMETERS		INCHES	
	MIN.	MAX.	MIN.	MAX.
A	1.75	2.05	0.069	0.081
B	1.75	2.18	0.069	0.086
C	0.85	1.15	0.033	0.045
D	0.40	0.69	0.016	0.027
F	0.70	1.00	0.028	0.039
H	-0.05	0.10	-0.002	0.004
J	0.10	0.25	0.004	0.010
K	3.60	3.90	0.142	0.154
L	0.50	0.80	0.020	0.031
R	1.20	1.50	0.047	0.059
S	0.50 REF		0.019 REF	

GENERIC MARKING DIAGRAMS*

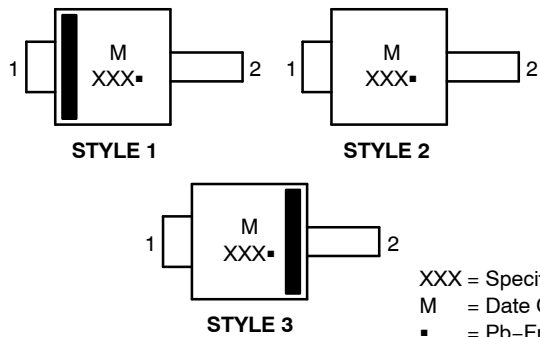

XXX = Specific Device Code
M = Date Code
■ = Pb-Free Package

NOTES:

- DIMENSIONING AND TOLERANCING PER ASME Y14.5M, 1994.
- CONTROLLING DIMENSION: MILLIMETERS
- DIMENSION b APPLIES TO PLATED TERMINAL AND IS MEASURED BETWEEN 0.15 AND 0.30mm FROM THE TERMINAL TIP.

STYLE 1:

- PIN 1. CATHODE
- ANODE

STYLE 2:

- ANODE OR CATHODE
- CATHODE OR ANODE (BI-DIRECTIONAL)

STYLE 3:

- PIN 1. ANODE
- CATHODE

*This information is generic. Please refer to device data sheet for actual part marking. Pb-Free indicator, "G" or microdot "▪", may or may not be present. Some products may not follow the Generic Marking.

DOCUMENT NUMBER:	98ASB14853C	Electronic versions are uncontrolled except when accessed directly from the Document Repository. Printed versions are uncontrolled except when stamped "CONTROLLED COPY" in red.
DESCRIPTION:	POWERMITE	PAGE 1 OF 1

onsemi and ONSEMI are trademarks of Semiconductor Components Industries, LLC dba onsemi or its subsidiaries in the United States and/or other countries. onsemi reserves the right to make changes without further notice to any products herein. onsemi makes no warranty, representation or guarantee regarding the suitability of its products for any particular purpose, nor does onsemi assume any liability arising out of the application or use of any product or circuit, and specifically disclaims any and all liability, including without limitation special, consequential or incidental damages. onsemi does not convey any license under its patent rights nor the rights of others.

onsemi, **Onsemi**, and other names, marks, and brands are registered and/or common law trademarks of Semiconductor Components Industries, LLC dba "**onsemi**" or its affiliates and/or subsidiaries in the United States and/or other countries. **onsemi** owns the rights to a number of patents, trademarks, copyrights, trade secrets, and other intellectual property. A listing of **onsemi**'s product/patent coverage may be accessed at www.onsemi.com/site/pdf/Patent-Marking.pdf. **onsemi** reserves the right to make changes at any time to any products or information herein, without notice. The information herein is provided "as-is" and **onsemi** makes no warranty, representation or guarantee regarding the accuracy of the information, product features, availability, functionality, or suitability of its products for any particular purpose, nor does **onsemi** assume any liability arising out of the application or use of any product or circuit, and specifically disclaims any and all liability, including without limitation special, consequential or incidental damages. Buyer is responsible for its products and applications using **onsemi** products, including compliance with all laws, regulations and safety requirements or standards, regardless of any support or applications information provided by **onsemi**. "Typical" parameters which may be provided in **onsemi** data sheets and/or specifications can and do vary in different applications and actual performance may vary over time. All operating parameters, including "Typicals" must be validated for each customer application by customer's technical experts. **onsemi** does not convey any license under any of its intellectual property rights nor the rights of others. **onsemi** products are not designed, intended, or authorized for use as a critical component in life support systems or any FDA Class 3 medical devices or medical devices with a same or similar classification in a foreign jurisdiction or any devices intended for implantation in the human body. Should Buyer purchase or use **onsemi** products for any such unintended or unauthorized application, Buyer shall indemnify and hold **onsemi** and its officers, employees, subsidiaries, affiliates, and distributors harmless against all claims, costs, damages, and expenses, and reasonable attorney fees arising out of, directly or indirectly, any claim of personal injury or death associated with such unintended or unauthorized use, even if such claim alleges that **onsemi** was negligent regarding the design or manufacture of the part. **onsemi** is an Equal Opportunity/Affirmative Action Employer. This literature is subject to all applicable copyright laws and is not for resale in any manner.

PUBLICATION ORDERING INFORMATION

LITERATURE FULFILLMENT:

Email Requests to: orderlit@onsemi.com

onsemi Website: www.onsemi.com

TECHNICAL SUPPORT

North American Technical Support:
Voice Mail: 1 800-282-9855 Toll Free USA/Canada
Phone: 011 421 33 790 2910

Europe, Middle East and Africa Technical Support:

Phone: 00421 33 790 2910

For additional information, please contact your local Sales Representative

