

MURS120T3 Series

Preferred Devices

Surface Mount Ultrafast Power Rectifiers

MURS105T3, MURS110T3, MURS115T3,
MURS120T3, MURS140T3, MURS160T3

Ideally suited for high voltage, high frequency rectification, or as free wheeling and protection diodes in surface mount applications where compact size and weight are critical to the system.

Features

- Small Compact Surface Mountable Package with J-Bend Leads
- Rectangular Package for Automated Handling
- High Temperature Glass Passivated Junction
- Low Forward Voltage Drop (0.71 to 1.05 V Max @ 1.0 A, $T_J = 150^\circ\text{C}$)
- Pb-Free Packages are Available

Mechanical Characteristics:

- Case: Epoxy, Molded
- Weight: 95 mg (Approximately)
- Finish: All External Surfaces Corrosion Resistant and Terminal Leads are Readily Solderable
- Lead and Mounting Surface Temperature for Soldering Purposes: 260°C Max. for 10 Seconds
- Polarity: Polarity Band Indicates Cathode Lead



ON Semiconductor®

<http://onsemi.com>

ULTRAFAST RECTIFIERS
1.0 AMPERE, 50–600 VOLTS



SMB
CASE 403A

MARKING DIAGRAM

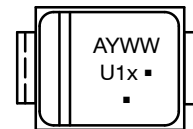

A = Assembly Location
Y = Year
WW = Work Week
U1 = Device Code
x = A, B, C, D, G, or J
▪ = Pb-Free Package

(Note: Microdot may be in either location)

ORDERING INFORMATION

See detailed ordering and shipping information in the table on page 2 of this data sheet.

DEVICE MARKING INFORMATION

See general marking information in the device marking table on page 2 of this data sheet.

Preferred devices are recommended choices for future use and best overall value.

MURS120T3 Series

MAXIMUM RATINGS

Rating	Symbol	MURS						Unit
		105T3	110T3	115T3	120T3	140T3	160T3	
Peak Repetitive Reverse Voltage Working Peak Reverse Voltage DC Blocking Voltage	V_{RRM} V_{RWM} V_R	50	100	150	200	400	600	V
Average Rectified Forward Current	$I_{F(AV)}$	1.0 @ $T_L = 155^\circ\text{C}$ 2.0 @ $T_L = 145^\circ\text{C}$			1.0 @ $T_L = 150^\circ\text{C}$ 2.0 @ $T_L = 125^\circ\text{C}$			A
Non-Repetitive Peak Surge Current, (Surge applied at rated load conditions halfwave, single phase, 60 Hz)	I_{FSM}	40			35			A
Operating Junction Temperature	T_J	- 65 to +175						$^\circ\text{C}$

Stresses exceeding Maximum Ratings may damage the device. Maximum Ratings are stress ratings only. Functional operation above the Recommended Operating Conditions is not implied. Extended exposure to stresses above the Recommended Operating Conditions may affect device reliability.

THERMAL CHARACTERISTICS

Rating	Symbol	MURS						Unit
		105T3	110T3	115T3	120T3	140T3	160T3	
Thermal Resistance, Junction-to-Lead ($T_L = 25^\circ\text{C}$)	$R_{\theta JL}$	13						$^\circ\text{C/W}$

ELECTRICAL CHARACTERISTICS

Maximum Instantaneous Forward Voltage (Note 1) ($i_F = 1.0\text{ A}$, $T_J = 25^\circ\text{C}$) ($i_F = 1.0\text{ A}$, $T_J = 150^\circ\text{C}$)	V_F	0.875 0.71			1.25 1.05			V
Maximum Instantaneous Reverse Current (Note 1) (Rated DC Voltage, $T_J = 25^\circ\text{C}$) (Rated DC Voltage, $T_J = 150^\circ\text{C}$)	i_R	2.0 50			5.0 150			μA
Maximum Reverse Recovery Time ($i_F = 1.0\text{ A}$, $di/dt = 50\text{ A}/\mu\text{s}$) ($i_F = 0.5\text{ A}$, $i_R = 1.0\text{ A}$, I_R to 0.25 A)	t_{rr}	35 25			75 50			ns
Maximum Forward Recovery Time ($i_F = 1.0\text{ A}$, $di/dt = 100\text{ A}/\mu\text{s}$, Rec. to 1.0 V)	t_{fr}	25			50			ns

1. Pulse Test: Pulse Width = 300 μs , Duty Cycle $\leq 2.0\%$.

DEVICE MARKING AND ORDERING INFORMATION

Device	Marking	Package	Shipping†
MURS105T3	U1A	SMB	2500 Units / Tape & Reel
MURS105T3G		SMB (Pb-Free)	
MURS110T3	U1B	SMB	
MURS110T3G		SMB (Pb-Free)	
MURS115T3	U1C	SMB	
MURS115T3G		SMB (Pb-Free)	
MURS120T3	U1D	SMB	
MURS120T3G		SMB (Pb-Free)	
MURS140T3	U1G	SMB	
MURS140T3G		SMB (Pb-Free)	
MURS160T3	U1J	SMB	
MURS160T3G		SMB (Pb-Free)	

†For information on tape and reel specifications, including part orientation and tape sizes, please refer to our Tape and Reel Packaging Specifications Brochure, BRD8011/D.

MURS120T3 Series

MURS105T3, MURS110T3, MURS115T3, MURS120T3

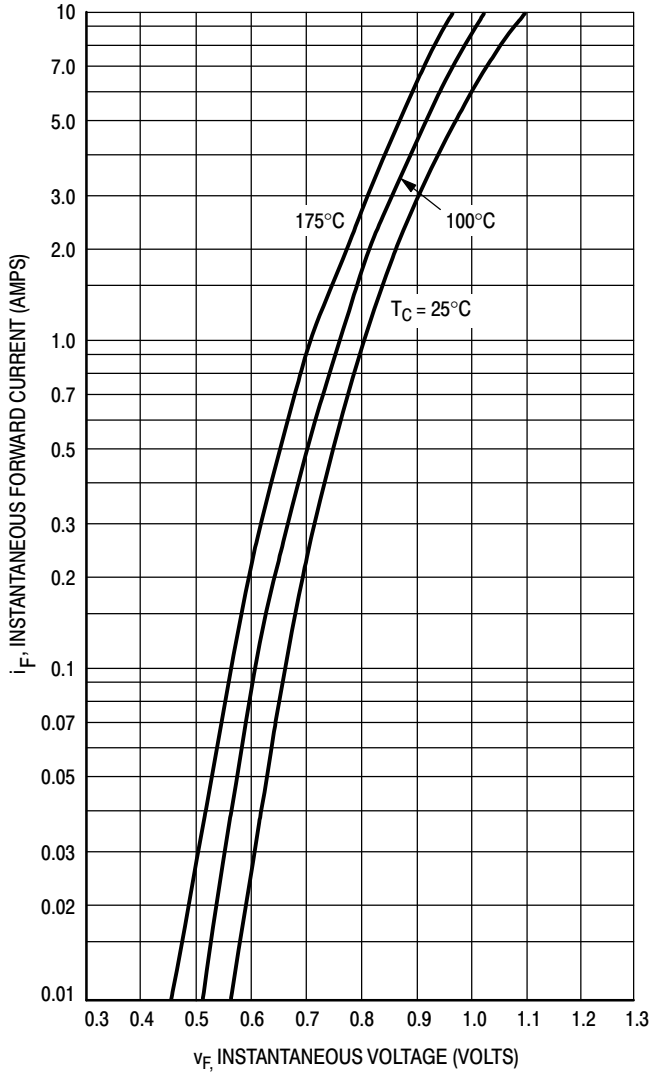

Figure 1. Typical Forward Voltage

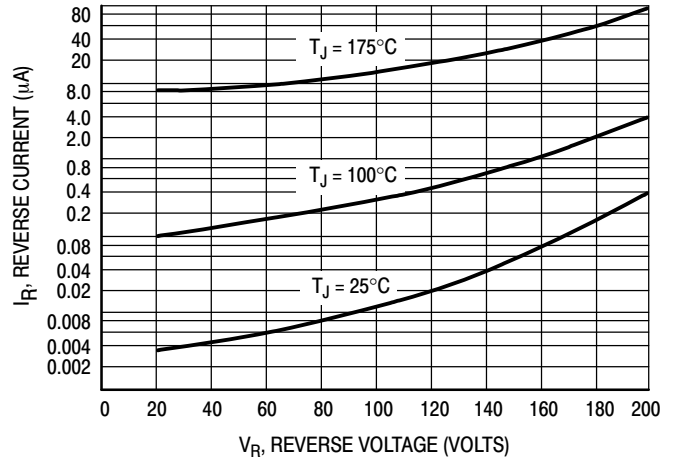

Figure 2. Typical Reverse Current*

*The curves shown are typical for the highest voltage device in the voltage grouping. Typical reverse current for lower voltage selections can be estimated from these same curves if applied V_R is sufficiently below rated V_R .

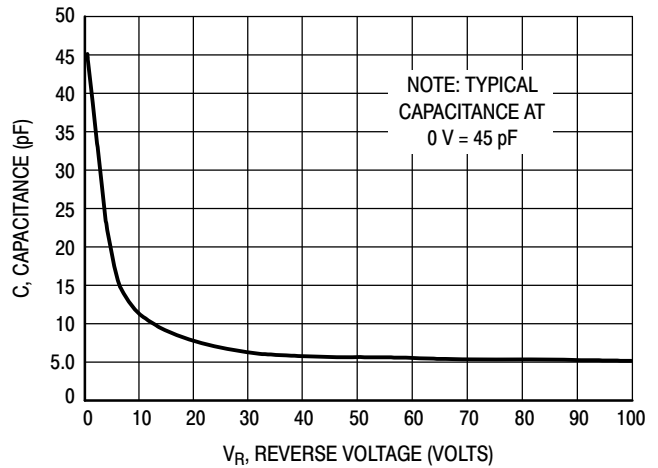

Figure 3. Typical Capacitance

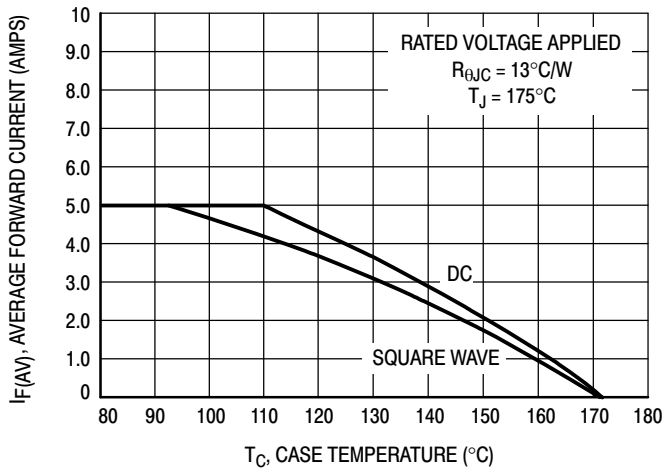

Figure 4. Current Derating, Case

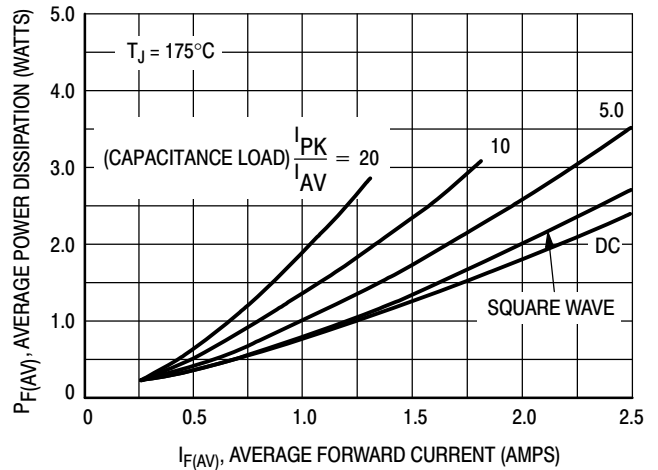

Figure 5. Power Dissipation

MURS120T3 Series

MURS140T3, MURS160T3

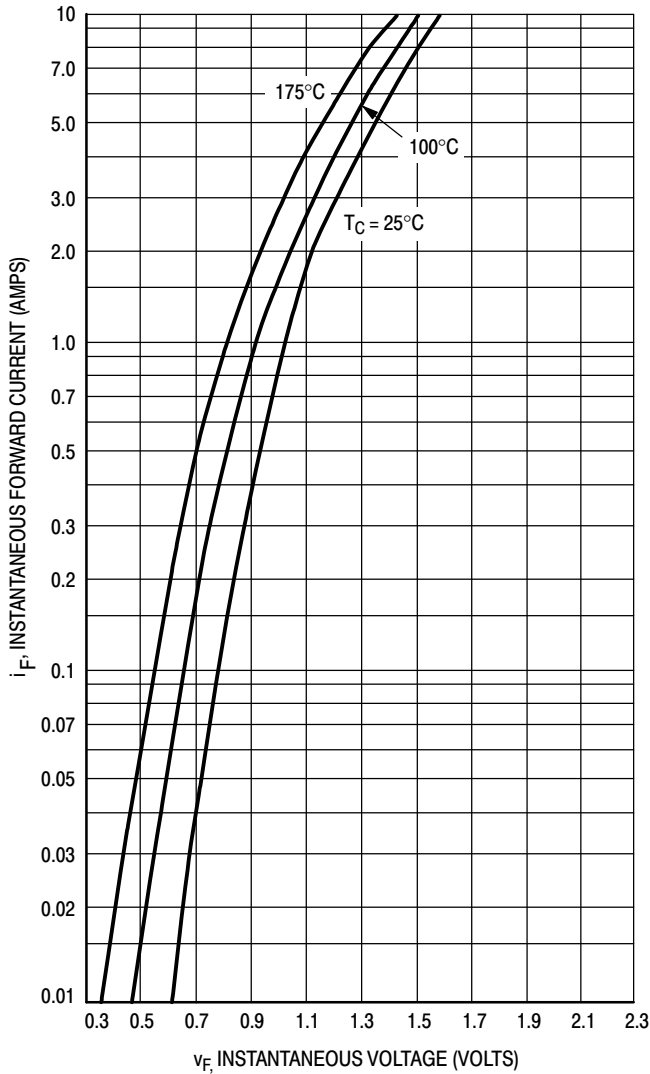

Figure 6. Typical Forward Voltage

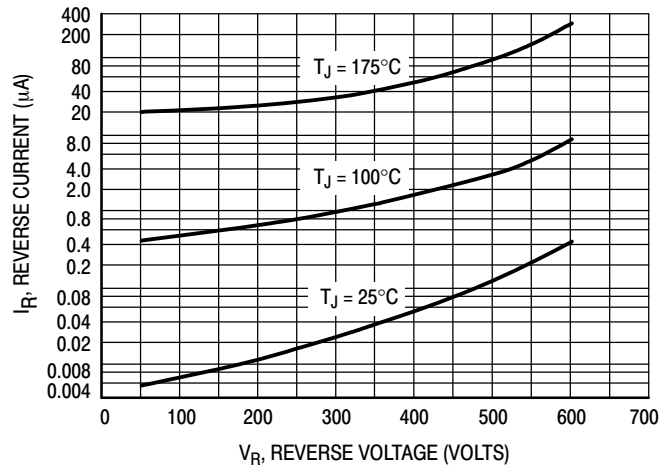

Figure 7. Typical Reverse Current*

*The curves shown are typical for the highest voltage device in the voltage grouping. Typical reverse current for lower voltage selections can be estimated from these same curves if applied V_R is sufficiently below rated V_R .

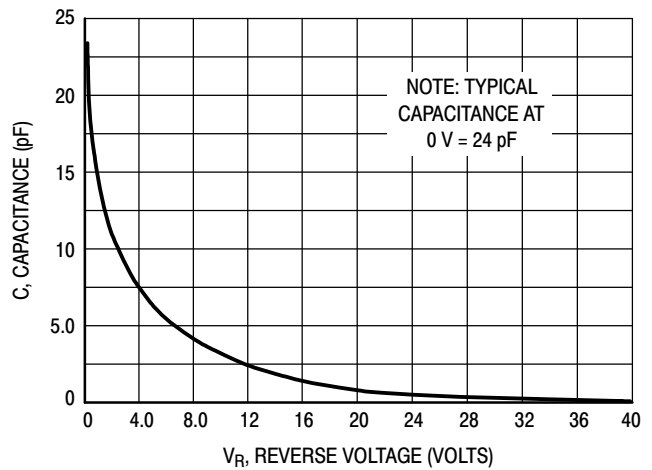

Figure 8. Typical Capacitance

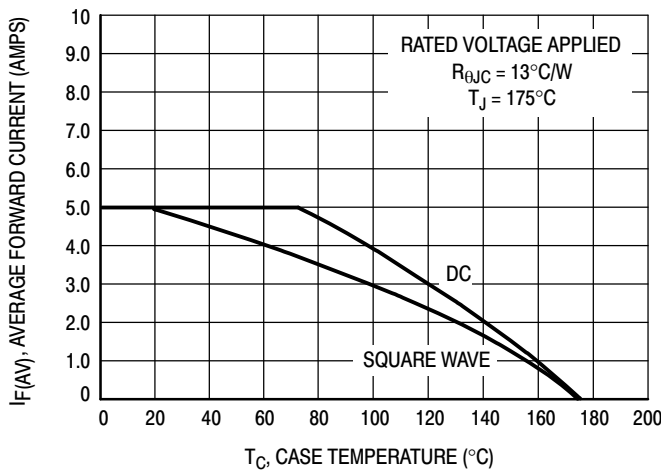

Figure 9. Current Derating, Case

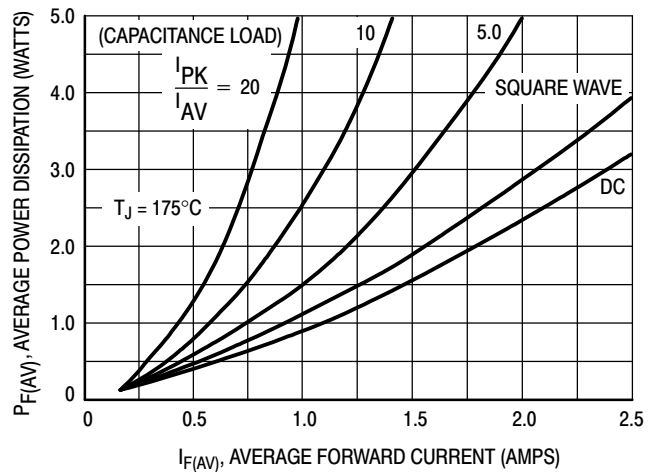
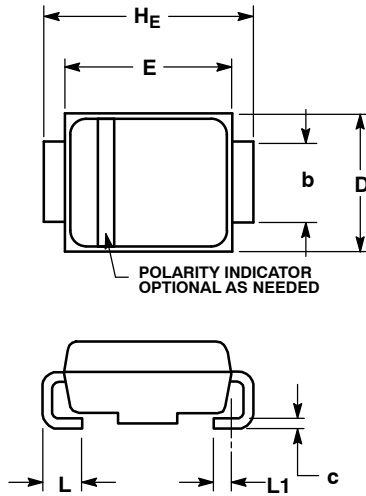

Figure 10. Power Dissipation

MURS120T3 Series

PACKAGE DIMENSIONS

SMB
CASE 403A-03
ISSUE G



- NOTES:
1. DIMENSIONING AND TOLERANCING PER ANSI Y14.5M, 1982.
 2. CONTROLLING DIMENSION: INCH.
 3. D DIMENSION SHALL BE MEASURED WITHIN DIMENSION P.

DIM	MILLIMETERS			INCHES		
	MIN	NOM	MAX	MIN	NOM	MAX
A	1.90	2.13	2.45	0.075	0.084	0.096
A1	0.05	0.10	0.20	0.002	0.004	0.008
b	1.96	2.03	2.20	0.077	0.080	0.087
c	0.15	0.23	0.31	0.006	0.009	0.012
D	3.30	3.56	3.95	0.130	0.140	0.156
E	4.06	4.32	4.60	0.160	0.170	0.181
HE	5.21	5.44	5.60	0.205	0.214	0.220
L	0.76	1.02	1.60	0.030	0.040	0.063
L1	0.51 REF			0.020 REF		

SOLDERING FOOTPRINT*

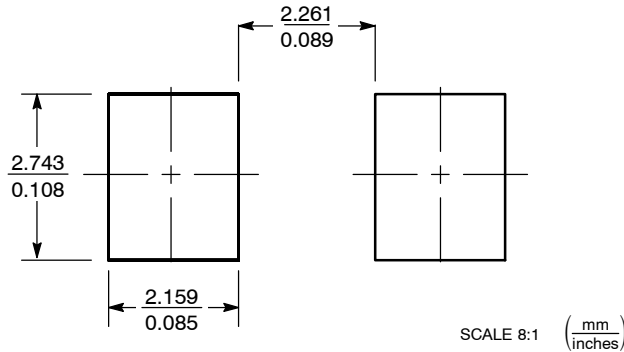

*For additional information on our Pb-Free strategy and soldering details, please download the ON Semiconductor Soldering and Mounting Techniques Reference Manual, SOLDERRM/D.

ON Semiconductor and are registered trademarks of Semiconductor Components Industries, LLC (SCILLC). SCILLC reserves the right to make changes without further notice to any products herein. SCILLC makes no warranty, representation or guarantee regarding the suitability of its products for any particular purpose, nor does SCILLC assume any liability arising out of the application or use of any product or circuit, and specifically disclaims any and all liability, including without limitation special, consequential or incidental damages. "Typical" parameters which may be provided in SCILLC data sheets and/or specifications can and do vary in different applications and actual performance may vary over time. All operating parameters, including "Typicals" must be validated for each customer application by customer's technical experts. SCILLC does not convey any license under its patent rights nor the rights of others. SCILLC products are not designed, intended, or authorized for use as components in systems intended for surgical implant into the body, or other applications intended to support or sustain life, or for any other application in which the failure of the SCILLC product could create a situation where personal injury or death may occur. Should Buyer purchase or use SCILLC products for any such unintended or unauthorized application, Buyer shall indemnify and hold SCILLC and its officers, employees, subsidiaries, affiliates, and distributors harmless against all claims, costs, damages, and expenses, and reasonable attorney fees arising out of, directly or indirectly, any claim of personal injury or death associated with such unintended or unauthorized use, even if such claim alleges that SCILLC was negligent regarding the design or manufacture of the part. SCILLC is an Equal Opportunity/Affirmative Action Employer. This literature is subject to all applicable copyright laws and is not for resale in any manner.

PUBLICATION ORDERING INFORMATION

LITERATURE FULFILLMENT:
Literature Distribution Center for ON Semiconductor
P.O. Box 5163, Denver, Colorado 80217 USA
Phone: 303-675-2175 or 800-344-3860 Toll Free USA/Canada
Fax: 303-675-2176 or 800-344-3867 Toll Free USA/Canada
Email: orderlit@onsemi.com

N. American Technical Support: 800-282-9855 Toll Free
USA/Canada
Europe, Middle East and Africa Technical Support:
Phone: 421 33 790 2910
Japan Customer Focus Center
Phone: 81-3-5773-3850

ON Semiconductor Website: www.onsemi.com
Order Literature: <http://www.onsemi.com/orderlit>

For additional information, please contact your local Sales Representative

MURS120T3/D