

HTMS1x01; HTMS8x01

HITAG μ transponder IC

Rev. 3.4 — 21 May 2015
152934

Product data sheet
COMPANY PUBLIC

1. General description

The HITAG product line is well known and established in the contactless identification market.

Due to the open marketing strategy of NXP Semiconductors there are various manufacturers well established for both the transponders/cards as well as the read/write devices. All of them supporting HITAG 1, HITAG 2 and HITAG S transponder ICs.

With the new HITAG μ family, this existing infrastructure is extended with the next generation of ICs being substantially smaller in mechanical size, lower in cost, offering more operation distance and speed, but still being operated with the same reader infrastructure and transponder manufacturing equipment.

The protocol and command structure for HITAG μ is design to support Reader Talks First (RTF) operation, including anti-collision algorithm.

Different memory sizes are offered and can be operated using exactly the same protocol.

1.1 Target markets

1.1.1 Animal identification

The ISO standards ISO 11784 and ISO 11785 are well established in this market and HITAG μ is especially designed to deliver the optimum performance compliant to these standards. The HITAG μ advanced ICs are offering additional memory for storage of customized offline data like further breeding details.

1.1.2 Laundry automation

- Identify 200 pcs of garment with one read/write device
- Long operation distance with typical small shaped laundry button transponders
- Insensitive to harsh conditions like pressure, heat and water



1.1.3 Beer keg and gas cylinder logistic

- Recognizing a complete pallet of gas cylinders at one time
- Long writing distance
- Voluntarily change between TTF Mode with user defined data length and read/write modes without changing the configuration on the transponder
- Authenticity check at the beer pubs - between beer bumper and supplied beer keg, provides a safe protection of the beer brand

1.1.4 Brand protection

- Authenticity check for high level brands or for original refilling e.g. toner for fax machines.

2. Features and benefits

2.1 Features

- Integrated circuit for contactless identification transponders and cards
- Integrated resonance capacitor of 210 pF with ± 3 % tolerance or 280 pF with ± 5 % tolerance over full production
- Frequency range 100 kHz to 150 kHz

2.2 Protocol

- Modulation read/write device \rightarrow transponder: 100 % ASK and binary pulse length coding
- Modulation transponder \rightarrow read/write device: Strong ASK modulation with anti-collision, Manchester and Biphase coding
- Fast anti-collision protocol
- Cyclic Redundancy Check (CRC)
- Transponder Talks First (TTF) mode
- Temporary switch from Transponder Talks First into Reader Talks First (RTF) Mode
- Data rate read/write device to transponder: 5.2 kbit/s
- Data rates transponder to read/write device: 2 kbit/s, 4 kbit/s, 8 kbit/s

2.3 Memory

- Different memory options
- Up to 10000 erase/write cycles
- 10 years non-volatile data retention
- Memory Lock functionality
- 32-bit password feature

2.4 Supported standards

- Full compliant to ISO 11784 and ISO 11785 Animal ID
- Designed to support ISO/IEC 14223 Animal ID with anticollision and read/write functionality

2.5 Security features

- 48-bit Unique Identification Number (UID)

2.6 Delivery types

- Sawn, gold-bumped 8" wafer
- HVSON2
- SOT-1122

3. Applications

- Animal identification
- Laundry automation
- Beer keg and gas cylinder logistic
- Brand protection

4. Quick reference data

Table 1. Quick reference data

Symbol	Parameter	Conditions	Min	Typ	Max	Unit	
Wafer EEPROM characteristics							
t_{ret}	retention time	$T_{amb} \leq 55\text{ }^{\circ}\text{C}$	10	-	-	year	
$N_{endu(W)}$	write endurance		100000	-	-	cycle	
Interface characteristics							
C_i	input capacitance	between LA and LB					
		HTMS1x01	[1][2]	203.7	210	216.3	pF
		HTMS8x01	[1][3]	266	280	294	pF

[1] Measured with an HP4285A LCR meter at 125 kHz/room temperature (25 °C); $V_{IN1-IN2} = 0.5\text{ V (RMS)}$

[2] Integrated Resonance Capacitor: 210 pF \pm 3 %

[3] Integrated Resonance Capacitor: 280 pF \pm 5 %

5. Ordering information

Table 2. Ordering information

Type number	Package	Description	Type	Version
HTMS1001FUG/AM	Wafer	sawn, megabumped wafer, 150 μ m, 8 inch, UV	HITAG μ , 210 pF	-
HTMS8001FUG/AM	Wafer	sawn, megabumped wafer, 150 μ m, 8 inch, UV	HITAG μ , 280pF	-
HTMS8101FUG/AM	Wafer	sawn, megabumped wafer, 150 μ m, 8 inch, UV	HITAG μ Advanced, 280 pF	-
HTMS8201FUG/AM	Wafer	sawn, megabumped wafer, 150 μ m, 8 inch, UV	HITAG μ Advanced+, 280 pF	-
HTMS8001FTB/AF	XSON3	plastic extremely thin small outline package; no leads; 4 terminals; body 1 \times 1.45 \times 0.5 mm	HITAG μ , 280 pF	SOT1122
HTMS8101FTB/AF	XSON3	plastic extremely thin small outline package; no leads; 4 terminals; body 1 \times 1.45 \times 0.5 mm	HITAG μ Advanced, 280 pF	SOT1122
HTMS8201FTB/AF	XSON3	plastic extremely thin small outline package; no leads; 4 terminals; body 1 \times 1.45 \times 0.5 mm	HITAG μ Advanced+, 280 pF	SOT1122
HTMS8001FTK/AF	HVSON2	plastic thermal enhanced very thin small outline package; no leads; 2 terminals; body 3 \times 2 \times 0.85 mm	HITAG μ , 280 pF	SOT899-1
HTMS8101FTK/AF	HVSON2	plastic thermal enhanced very thin small outline package; no leads; 2 terminals; body 3 \times 2 \times 0.85 mm	HITAG μ Advanced, 280 pF	SOT899-1
HTMS8201FTK/AF	HVSON2	plastic thermal enhanced very thin small outline package; no leads; 2 terminals; body 3 \times 2 \times 0.85 mm	HITAG μ Advanced+, 280 pF	SOT899-1

6. Block diagram

The HITAG μ transponder ICs require no external power supply. The contactless interface generates the power supply and the system clock via the resonant circuitry by inductive coupling to the Read/Write Device (RWD). The interface also demodulates data transmitted from the RWD to the HITAG μ transponder IC, and modulates the magnetic field for data transmission from the HITAG μ transponder IC to the RWD.

Data are stored in a non-volatile memory (EEPROM). The EEPROM has a capacity of up to 1760 bit and is organized in blocks.

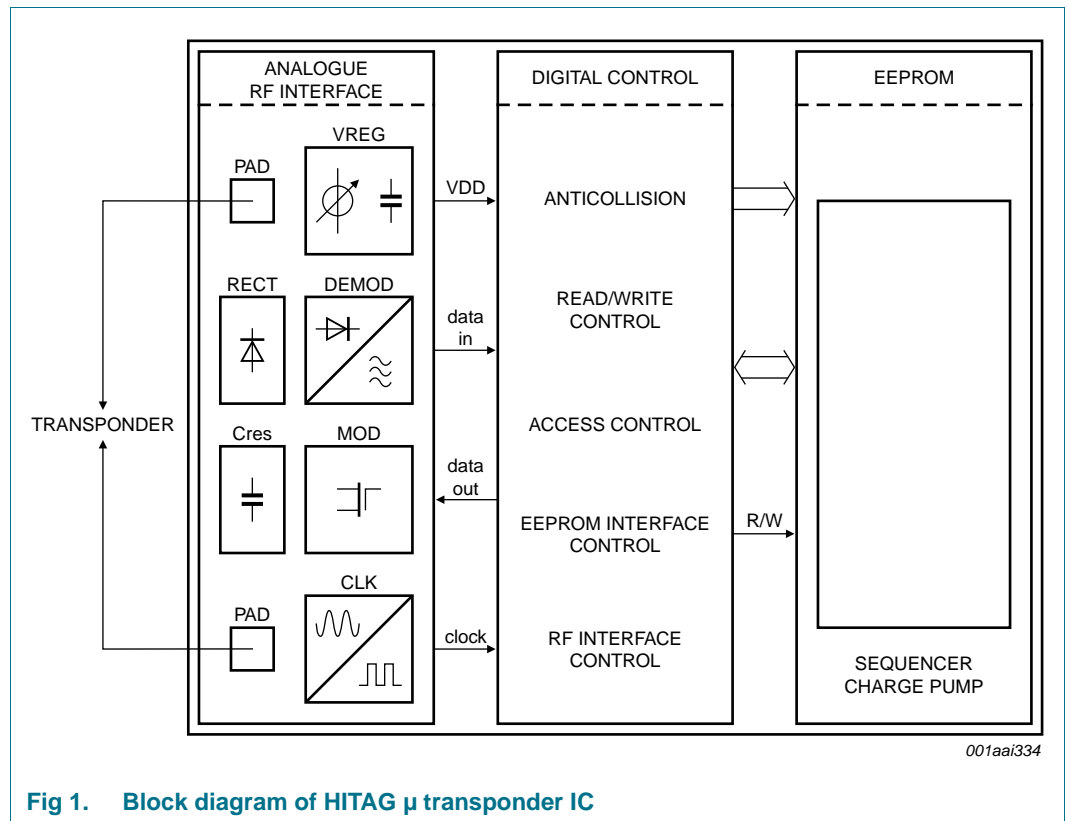

Fig 1. Block diagram of HITAG μ transponder IC

7. Pinning information

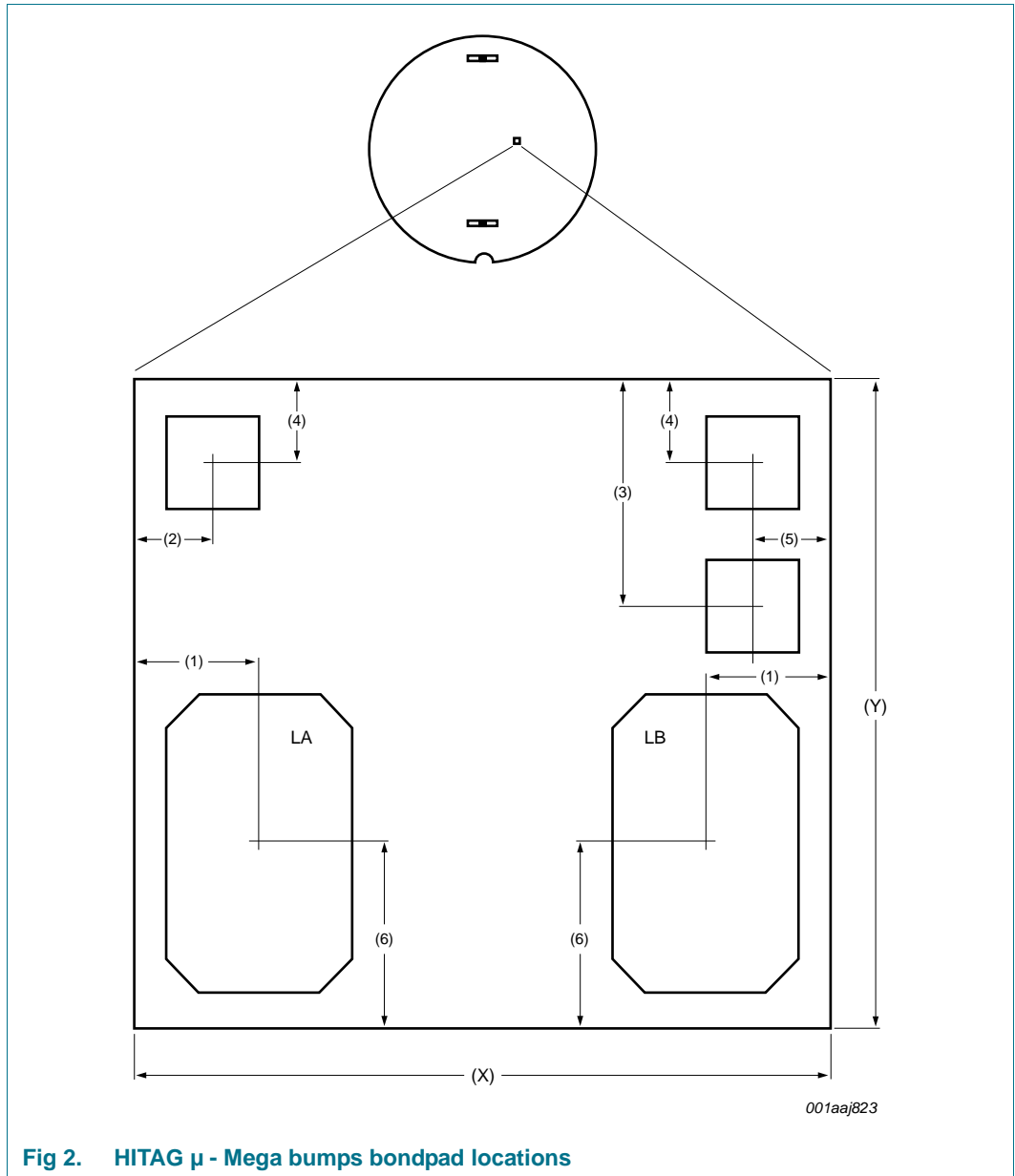

Fig 2. HITAG μ - Mega bumps bondpad locations

Table 3. HITAG μ - Mega bumps dimensions

Description	Dimension
(X) chip size	550 μ m
(Y) chip size	550 μ m
(1) pad center to chip edge	100.5 μ m
(2) pad center to chip edge	48.708 μ m
(3) pad center to chip edge	180.5 μ m
(4) pad center to chip edge	55.5 μ m
(5) pad center to chip edge	48.508 μ m

Table 3. HITAG μ - Mega bumps dimensions

Description	Dimension
(6) pad center to chip edge	165.5 μm
Bump Size:	
LA, LB	294 x 164 μm
Remaining pads	60 x 60 μm

Note: All pads except LA and LB are electrically disconnected after dicing.

8. Mechanical specification

8.1 Wafer specification

See [Ref. 2 "General specification for 8" wafer on UV-tape with electronic fail die marking"](#).

Table 4. Wafer specification

Wafer	
Designation	each wafer is scribed with batch number and wafer number
Diameter	200 mm (8 inches)
Thickness	150 $\mu\text{m} \pm 15 \mu\text{m}$
Process	CMOS 0.14 μm
Batch size	25 wafers
PGDW	91981
Wafer backside	
Material	Si
Treatment	ground and stress release
Roughness	R_a max. 0.5 μm , R_t max. 5 μm
Chip dimensions	
Die size without scribe	550 $\mu\text{m} \times 550 \mu\text{m} = 302500 \mu\text{m}^2$
Scribe line width	
X-dimension	15 μm (scribe line width measured between nitride edges)
Y-dimension	15 μm (scribe line width measured between nitride edges)
Number of pads	5
Passivation on front	
Type	sandwich structure
Material	PE-nitride (on top)
Thickness	1.75 μm total thickness of passivation
Au bump	
Material	>99.9 % pure Au
Hardness	35 HV to 80 HV 0.005
Shear strength	>70 MPa
Height	18 μm
Height uniformity	
within a die	$\pm 2 \mu\text{m}$
within a wafer	$\pm 3 \mu\text{m}$
wafer to wafer	$\pm 4 \mu\text{m}$
Bump flatness	$\pm 1.5 \mu\text{m}$
Bump size	
LA, LB	294 $\mu\text{m} \times 164 \mu\text{m}$
TEST, GND, VDD	60 $\mu\text{m} \times 60 \mu\text{m}$
variation	$\pm 5 \mu\text{m}$
Under bump metallization	sputtered TiW

8.1.1 Fail die identification

No inkdots are applied to the wafer.

Electronic wafer mapping (SECS II format) covers the electrical test results and additionally the results of mechanical/visual inspection.

See [Ref. 2 "General specification for 8" wafer on UV-tape with electronic fail die marking"](#).

8.1.2 Map file distribution

See [Ref. 2 "General specification for 8" wafer on UV-tape with electronic fail die marking"](#).

9. Functional description

9.1 Memory organization

The EEPROM has a capacity of up to 1760 bit and is organized in blocks of 4 bytes each (1 block = 32 bits). A block is the smallest access unit.

The HITAG μ transponder IC is available with different memory sizes as shown in [Table 5](#) “Memory organization HITAG m (128-bit)”, [Table 6](#) “Memory organization HITAG μ Advanced (512 bit)” and [Table 7](#) “Memory organization HITAG μ Advanced+ (1760 bit)”.

For permanent lock of blocks please refer to [Section 14.9 “LOCK BLOCK”](#).

9.1.1 Memory organization HITAG μ transponder ICs

Table 5. Memory organization HITAG μ (128-bit)

Block address	Content	Password Access
FFh	User Config	
FEh	PWD	
03h	ISO 11784/ISO 11785 128 bit TTF data	bit3=0 R/W ^[2] bit3=1 RO ^[1]
02h		
01h		
00h		

[1] RO: Read without password, write with password

[2] R/W: Read and write without password

9.1.2 Memory organization HITAG μ Advanced

Table 6. Memory organization HITAG μ Advanced (512 bit)

Block address	Content	Password Access
FFh	User Config	
FEh	PWD	
0Fh	User Memory	bit4=0 R/W ^[2] bit4=1 RO ^[1]
0Eh		
0Dh		
0Ch		
0Bh		
0Ah		
09h		
08h		
07h		
06h		
05h		
04h	ISO 11784/ISO 11785 128-bit TTF data	bit3=0 R/W ^[2] bit3=1 RO ^[1]
03h		
02h		
01h		
00h		

[1] RO: Read without password, write with password

[2] R/W: Read and write without password

9.1.3 Memory organization HITAG μ Advanced +

Table 7. Memory organization HITAG μ Advanced+ (1760 bit)

Block address	Content	Password Access
FFh	User Config	
FEh	PWD	
36h	User Memory	bit6=0 bit5=0 R/W ^[2] bit6=0 bit5=1 RO ^[1] bit6=1 bit5=0 R/W(P) ^[3] bit6=1 bit5=1 R/W(P) ^[3]
35h		
...		
14h		
13h		
12h		
11h		
10h	User Memory	bit4=0 R/W ^[2] bit4=1 RO ^[1]
0Fh		
0Eh		
0Dh		
0Ch		
0Bh		
0Ah		
09h		
08h		
07h		
06h	ISO 11784/ISO 11785 128-bit TTF data	bit3=0 R/W ^[2] bit3=1 RO ^[1]
05h		
04h		
03h		
02h		
01h		
00h		

[1] RO: Read without password, write with password

[2] R/W: Read and write without password

[3] R/W(P): Read and write with password

9.2 Memory configuration

The user configuration block consists of one configurable byte (Byte0) and three reserved bytes (Byte1 to Byte3)

The bits in the user configuration block enable a customized configuration of the HITAG μ transponder ICs. In TTF mode the user can choose Bi-phase or Manchester encoding and also the data rate for the return link (bit0 to bit2). In RTF mode data rate and coding are fixed with 4 kbit/s Manchester encoding.

Fitting to ISO 11785 standard the default values are set for 4 kbit/s Bi-Phase encoding. The next four bits (bit 3 to bit 6) are used for password settings.

Three areas (TTF area(128bit), lower 512 bits and upper memory) can be restricted to read/write access.

The user configuration block (User Config) is programmable by using WRITE SINGLE BLOCK command at address FFh. Bits 7 to 31 (Byte1 to Byte3) are reserved for further usage.

The user configuration block (block address FFh) and the password block (block address FEh) can be locked with the LOCK BLOCK command.

Attention:

- Pre-programmed default values are not locked !
- Configuration block has to be locked to make data unalterable!
- The lock of the blocks is permanently and therefore irreversible!

Table 8. User configuration block to Byte0

Byte0						Description
bit6	bit5	bit4	bit3	bit2	bit1 ... 0	Bit-no.
PWD (r/w) [2] Bit512... Max	PWD (w) [1] Bit512... Max	PWD (w) [1] Bit128... 511	PWD (w) [1] Bit0... 127	Encoding	Data rate	
				0... MCH 1... Bi-Ph.	'00'... 2kbit/s '01'... 4kbit/s '10'... 8kbit/s	Value/meaning

[1] PWD(w)=1: read without password and write with password

[2] PWD(r/w)=1: read and write with password

10. General requirements

The HITAG μ transponder ICs are compatible with ISO 11785. At the time a HITAG μ transponder IC is in the interrogator field it will respond according to ISO 11785.

A HITAG μ advanced/advanced+ can be identified as a transponder being in the data exchange mode (advanced mode) by the type information in the reserved bit field sent to the RWD.

- Bit 15 of the ISO 11784 frame shall be set to '1' indicating that this is an HITAG μ advanced/advanced+ in data exchange mode.
- Bit 16 of the ISO 11784 frame (additional data flag set to '1', indicating that the HITAG μ advanced/advanced+ in data exchange mode contains additional data in the user memory area.

To bring the HITAG μ transponder ICs into the data exchange mode, the RWD needs to send a valid request or a valid switch command within the defined listening window.

A HITAG μ transponder IC in data exchange mode only responds when requested by the RWD (RTF mode).

The identification code, all communication from reader to HITAG μ transponder ICs and vice versa and the CRC error detection bits (if applicable) are transmitted starting with LSB first.

In the case that multiple HITAG μ advanced/advanced+ in data exchange mode are in the interrogation field which cause collisions the RWD has to start the anticollision procedure as described in this document. Depending in which part of the ISO 11785 timing frame the collision is detected the RWD will start with the anticollision request.

The HITAG μ transponder IC in data exchange mode switches back to the standard ISO 11785 mode when it :

- is no longer in the interrogation field
- has terminated the data exchange mode operations and the interrogation field was switched off for at least 5 ms afterwards

11. HITAG μ transponder IC air interface

11.1 Downlink description

To transfer the HITAG μ transponder ICs into the data exchange mode, the RWD's interrogation field needs be switched off. After this off-period, the interrogation field is switched on again, and either the SOF at the start of a valid request or the special switch command needs to be sent to the HITAG μ transponder IC within the specified switch time window. The HITAG μ transponder IC switches itself into the data exchange mode upon reception of any of the switch commands. In this mode, the HITAG μ transponder IC respond when requested by the RWD (reader driven protocol).

The HITAG μ transponder IC in data exchange mode switches back to the ISO 11785 mode after the interrogation field has been switched off for at least 5 ms.

The steps necessary to transfer the HITAG μ transponder IC into the data exchange mode are shown in Figure 3. The downlink communication takes place in period C and D. The example in Figure 3 shows two data blocks (#1 and #2) being selected by the RWD, which then are transmitted by the HITAG μ transponder IC.

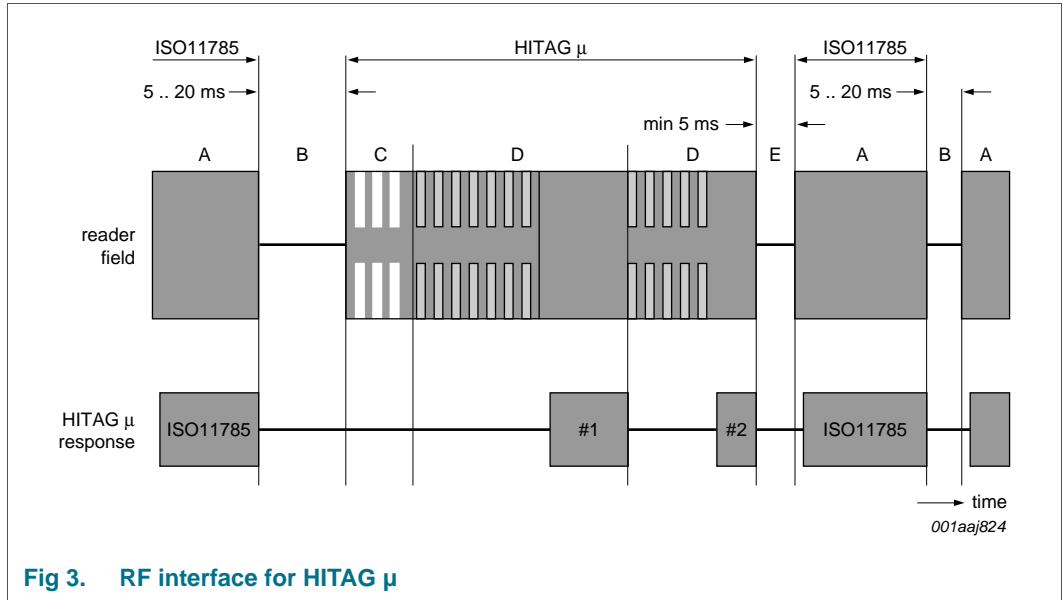

Fig 3. RF interface for HITAG μ

Table 9. RF interface for HITAG μ

Cycle A:	The RWD reads the ISO 11785 frame.
Cycle B:	The RWD switches off the interrogation field for at least 5 ms in order to reset the HITAG μ transponder IC.
Cycle C:	The RWD sends either the SOF at the start of a valid request or the SWITCH command to the HITAG μ transponder IC in order to put it into the data exchange mode. Any of these has to be issued within the switch window after reset - as defined in Section 11.2 "Mode switching protocol"
Cycle D:	Read/Write (for HITAG μ transponder ICs) or Inventory (HITAG μ advanced/advanced+ transponder ICs) operation in the data exchange mode.
Cycle E:	After all operations are finished or the HITAG μ transponder IC left the antenna field, the RWD switches off the field for at least 5 ms in order to poll for new incoming HITAG μ or HITAG μ advanced/advanced+.

11.2 Mode switching protocol

After powering the HITAG μ transponder IC switches to the data exchange mode after receiving one of the two possible switch commands from the RWD during the specified switch window (see [Table 10](#) and [Figure 4](#) for details).

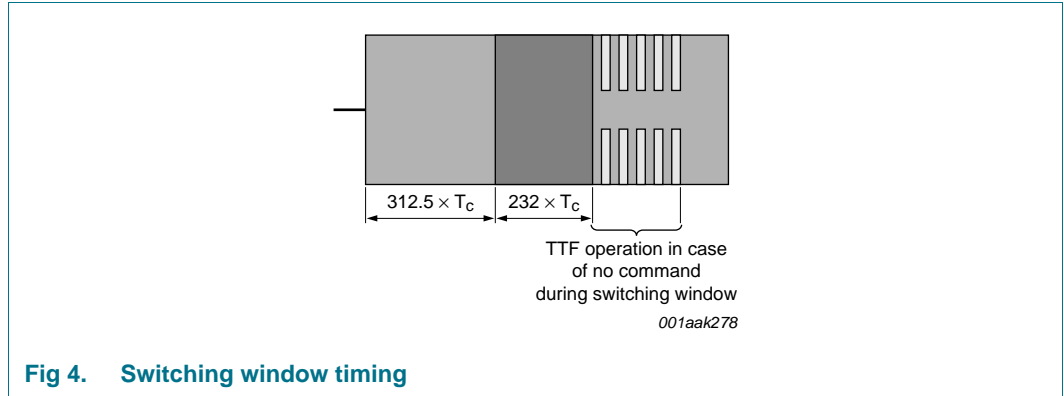

Fig 4. Switching window timing

Table 10. HITAG μ transponder IC air interface parameters [\[1\]](#)

Parameter	Description
Interrogation field modulation	Amplitude modulation (ASK), 90 - 100%
Encoding	Pulse Interval Encoding; Least Significant Bit (LSB) first
Bit rate	5.2 kbit/s typically
Mode switching	Either a specific 5 bit switch command or the detection of the SOF as part of a valid HITAG μ transponder IC command, transmitted after the interruption of the interrogation field for at least 5 ms
Mode switch timing	HITAG μ transponder IC settling time: $312.5 \times T_C$ switch command window after HITAG μ transponder IC settling: $232.5 \times T_C$ All within cycle C in Figure 3 .
Mode switch command	00011 or SOF sequence

[1] T_C ...Carrier period time ($1/134.2$ kHz = 7.45 μs nominal)

The RWD sends either the SOF at the start of a valid request or a special switch command to the HITAG μ (as shown in [Figure 5](#)) in order to transfer it into the data exchange mode.

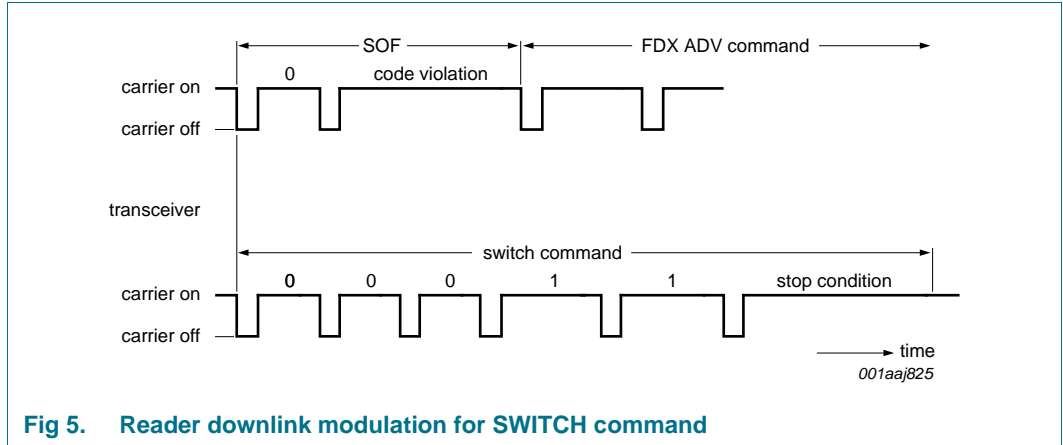

Fig 5. Reader downlink modulation for SWITCH command

11.2.1 SWITCH

Setting the transponder into data exchange mode (advanced mode) is done by sending SOF pattern or the switch command within the listening window ($232.5 \times T_C$). The SWITCH command itself does not contain SOF and EOF.

Table 11. SWITCH Command

Command	Description
5	No. of bits
00011	

11.3 Downlink communication signal interface - RWD to HITAG μ transponder IC

11.3.1 Modulation parameters

Communications between RWD and HITAG μ transponder IC takes place using ASK modulation with a modulation index of $m > 90\%$.

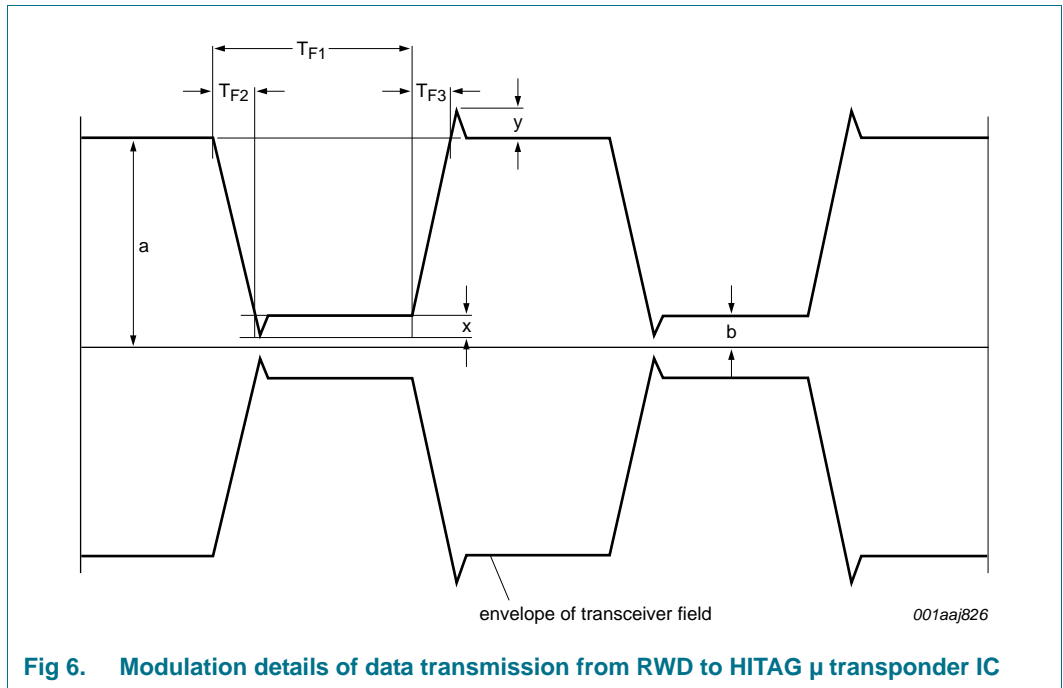

Fig 6. Modulation details of data transmission from RWD to HITAG μ transponder IC

Table 12. Modulation coding times^{[1][2]}

Symbol	Min	Max
$m = (a-b)/(a+b)$	90%	100%
T_{F1}	$4 \times T_c$	$10 \times T_c$
T_{F2}	0	$0.5 \times T_{F1}$
T_{F3}	0	$0.5 \times T_{Fd0}$
x	0	$0.05 \times a$
y	0	$0.05 \times a$

[1] T_{F3} shall not exceed $T_{Fd0} - T_{F1} - 3 \times T_c$

[2] T_c ...Carrier period time ($1/134.2 \text{ kHz} = 7.45 \mu\text{s}$ nominal)

11.3.2 Data rate and data coding

The RWD to HITAG μ transponder IC communication uses Pulse Interval Encoding. The RWD creates pulses by switching the carrier off as described in Figure 7. The time between the falling edges of the pulses determines either the value of the data bit '0', the data bit '1', a code violation or a stop condition.

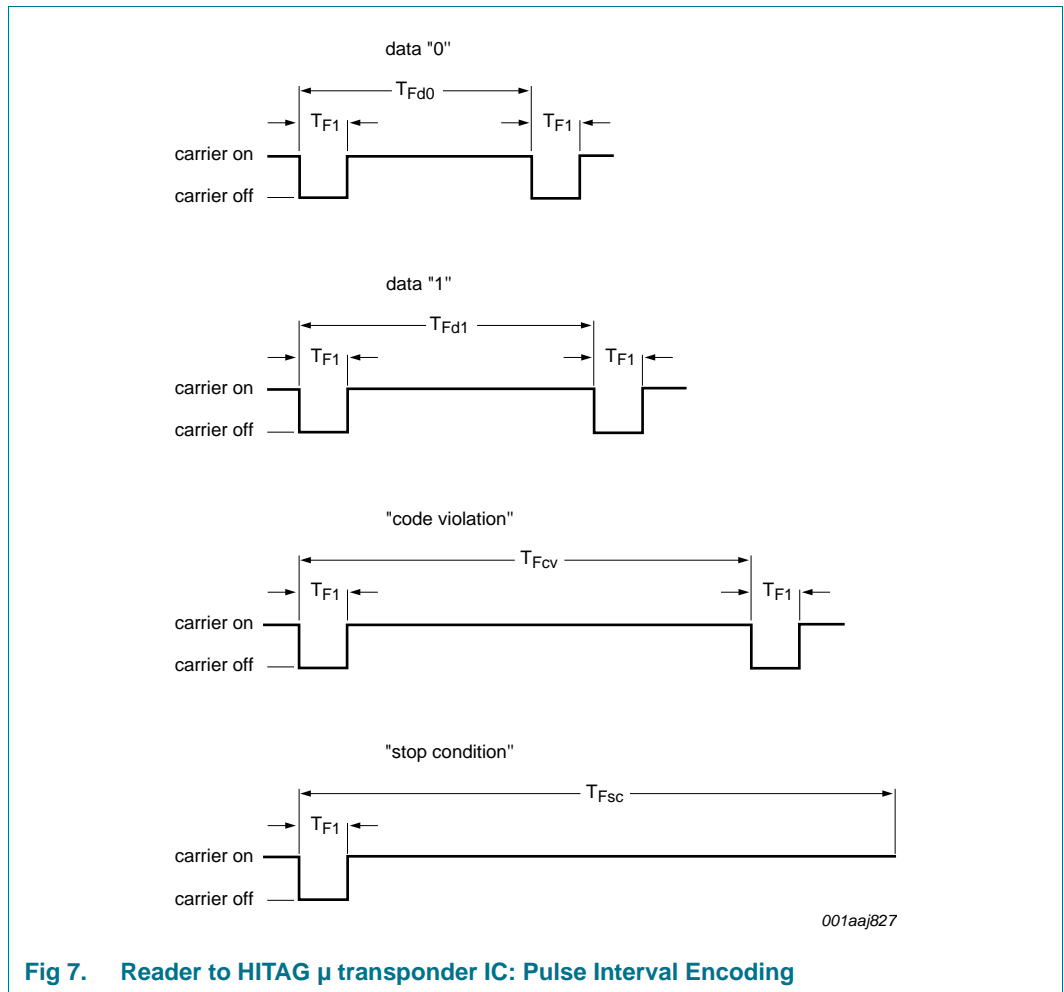

Fig 7. Reader to HITAG μ transponder IC: Pulse Interval Encoding

Assuming equal distributed data bits '0' and '1', the data rate is in the range of about 5.2 kbit/s.

Table 13. Data coding times [1]

Meaning	Symbol	Min	Max
Carrier off time	T_{F1}	$4 \times T_c$	$10 \times T_c$
Data "0" time	T_{Fd0}	$18 \times T_c$	$22 \times T_c$
Data "1" time	T_{Fd1}	$26 \times T_c$	$30 \times T_c$
Code violation time	T_{Fcv}	$34 \times T_c$	$38 \times T_c$
Stop condition time	T_{Fsc}	$\geq 42 \times T_c$	n/a

[1] T_c ...Carrier period time ($1/134.2$ kHz = 7.45 μ s nominal)

11.3.3 RWD - Start of frame pattern

The RWD requests in the data exchange mode always a start with a SOF pattern for ease of synchronization. The SOF pattern consists of an encoded data bit '0' and a 'code violation'.

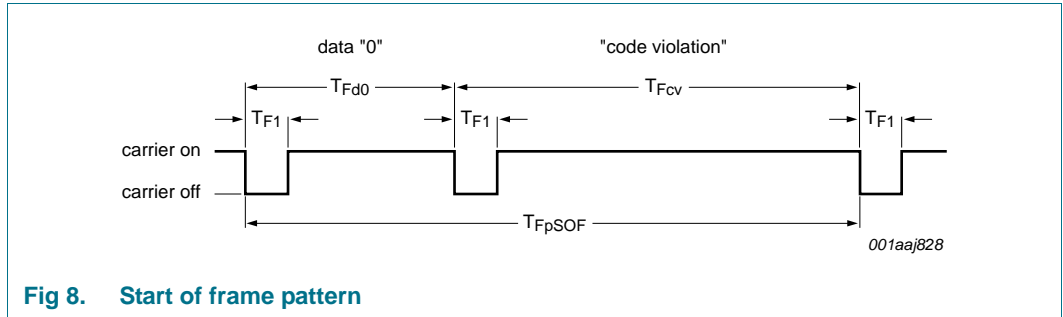

Fig 8. Start of frame pattern

The HITAG μ advanced/advanced+ is ready to receive a SOF from the RWD within 1.2 ms after having sent a response to the RWD.

The HITAG μ advanced/advanced+ is ready to receive a SOF or switch command from the RWD within 2.33 ms after the RWD has established the powering field.

11.3.4 RWD - End of frame pattern

For slot switching during a multi-slot anticollision sequence, the RWD request is an EOF pattern. The EOF pattern is represented by a RWD 'Stop condition'.

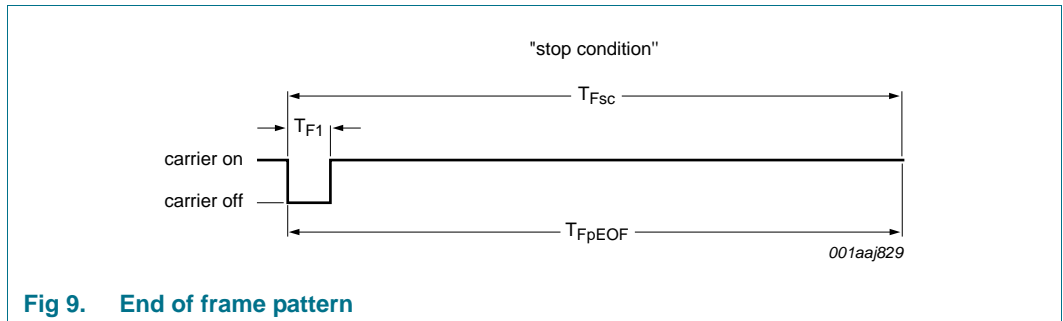

Fig 9. End of frame pattern

11.4 Communication signal interface - HITAG μ transponder IC to RWD

11.4.1 Data rate and data coding

The HITAG μ transponder IC accepts the following data rates and encoding schemes:

- $1/T_{Fd}$ Differential bi-phase coded data signal in the ISO 11785 mode, without SOF and EOF
- $1/T_{Fd}$ Manchester coded data signal on the response to the HITAG μ advanced/advanced+ commands in data exchange mode
- $1/(2 \times T_{Fd})$ dual pattern data coding when responding within the inventory process
- TTF mode (not ISO 11785 compliant): $1/(2 \times T_{Fd})$, $2/T_{Fd}$ Manchester or bi-phase coded

$$T_{Fd} = 32 / f_c = 32 \times T_c$$

Remark: The slower data rate used during the inventory process allows for improving the collision detection when several HITAG μ transponder ICs are present in the RWD field, especially if some HITAG μ transponder ICs are in the near field and others in the far field.

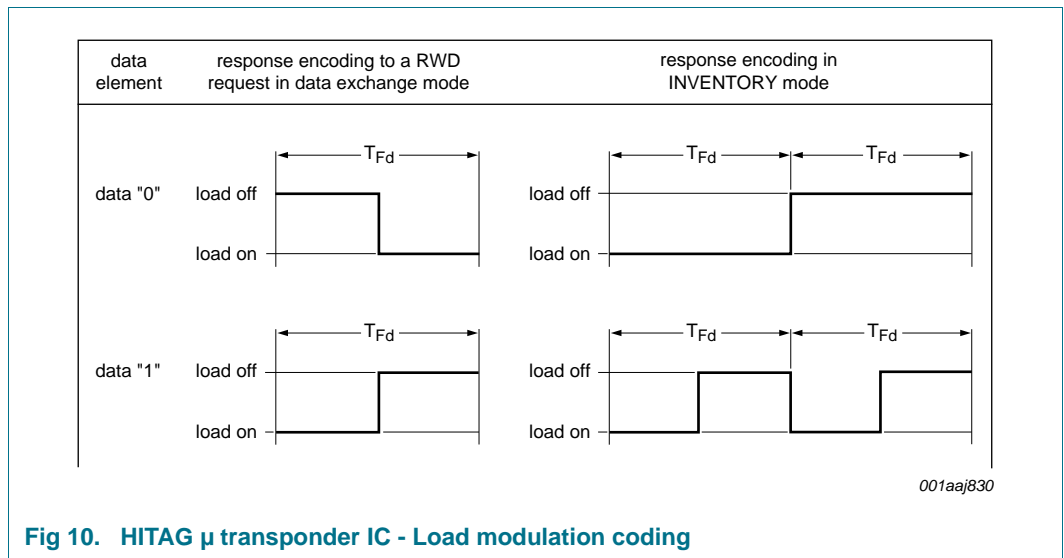

Fig 10. HITAG μ transponder IC - Load modulation coding

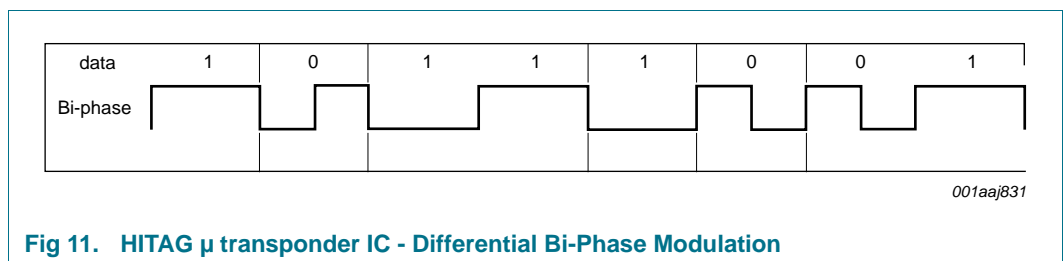

Fig 11. HITAG μ transponder IC - Differential Bi-Phase Modulation

Differential Bi-phase (or FM0 respectively) contains a transition in the center of bit conversion representing Data '0' and no one for Data '1'. At the beginning of every bit modulation a level transition must be performed.

11.4.2 Start of frame pattern

The HITAG μ transponder IC response - if not in ISO 11785 compliant mode - always starts with a SOF pattern. The SOF is a Manchester encoded bit sequence of '110'.

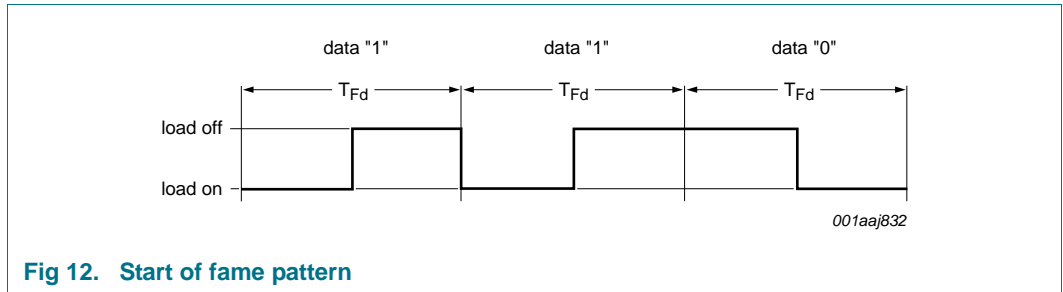

Fig 12. Start of fame pattern

11.4.3 End of frame pattern

A specific EOF pattern is neither used nor specified for the HITAG μ transponder IC response. An EOF is detected by the reader if there is no load modulation for more than two data bit periods (T_{Fd}).

12. General protocol timing specification

For requests where an EEPROM erase and/or programming operation is required, the transponder IC returns its response when it has completed the write/lock operation. This will be after 20 ms upon detection of the last falling edge of the interrogator request or after the interrogator has switched off the field.

12.1 Waiting time before transmitting a response after an EOF from the RWD

When the HITAG advanced/advanced+ in data exchange mode has detected an EOF of a valid RWD request or when this EOF is in the normal sequence of a valid RWD request, it waits for T_{Fp1} before starting to transmit its response to a RWD request or when switching to the next slot in an inventory process.

T_{Fp1} starts from the detection of the falling edge of the EOF received from the RWD.

Remark: The synchronization on the falling edge from the RWD to the EOF of the HITAG μ transponder ICs is necessary to ensure the required synchronization of the HITAG μ transponder IC responses.

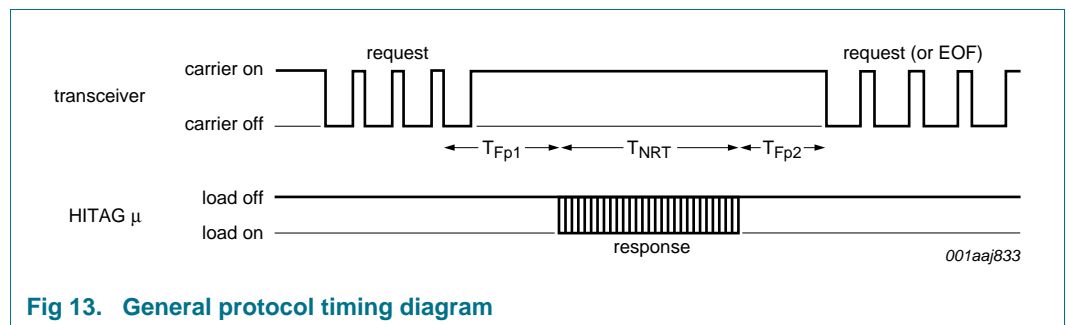

Fig 13. General protocol timing diagram

The minimum value of T_{Fp1} is $T_{Fp1min} = 204 \times T_C$

The typical value of T_{Fp1} is $T_{Fp1typ} = 209 \times T_C$

The maximum value of T_{Fp1} is $T_{Fp1max} = 213 \times T_C$

If the HITAG μ transponder IC detects a carrier modulation during this time (T_{Fp1}), it shall reset its T_{Fp1} -timer and wait for a further time (T_{Fp1}) before starting to transmit its response to a RWD request or to switch to the next slot when in an inventory process.

12.2 RWD waiting time before sending a subsequent request

- When the RWD has received a HITAG μ advanced/advanced+ response to a previous request other than inventory and quiet, it needs to wait T_{Fp2} before sending a subsequent request. T_{Fp2} starts from the time the last bit has been received from the HITAG μ advanced/advanced+.
- When the RWD has sent a quiet request, it needs to wait T_{Fp2} before sending a subsequent request. T_{Fp2} starts from the end of the quiet request's EOF (falling edge of EOF pulse + $42 \times T_C$). This results in awaiting time of $(150 \times T_C + 42 \times T_C)$ before the next request.

The minimum value of T_{Fp2} is $T_{Fp2min} = 150 \times T_C$ ensures that the HITAG μ advanced/advanced+ ICs are ready to receive a subsequent request.

Remark: The RWD needs to wait at least 2.33 ms after it has activated the electromagnetic field before sending the first request, to ensure that the HITAG μ transponder ICs are ready to receive a request.

- When the RWD has sent an inventory request, it is in an inventory process.

12.3 RWD waiting time before switching to next inventory slot

An inventory process is started when the RWD sends an inventory request. For a detailed explanation of the inventory process refer to [Section 14.3](#) and [Section 14.4](#).

To switch to the next slot, the RWD sends an EOF after waiting a time period specified in the following sub-clauses.

12.3.1 RWD started to receive one or more HITAG μ transponder IC responses

During an inventory process, when the RWD has started to receive one or more HITAG μ advanced/advanced+ transponder IC responses (i.e. it has detected a HITAG μ advanced/advanced+ transponder IC SOF and/or a collision), it shall

- wait for the complete reception of the HITAG μ advanced/advanced+ transponder IC responses (i.e. when a last bit has been received or when the nominal response time T_{NRT} has elapsed),
- wait an additional time T_{Fp2} and then send an EOF to switch to the next slot, if a 16 slot anticollision request is processed, or send a subsequent request (which could be again an inventory request).

T_{Fp2} starts from the time the last bit has been received from the HITAG μ advanced/advanced+ transponder IC.

The minimum value of T_{Fp2} is $T_{Fp2min} = 150 \times T_C$.

T_{NRT} is dependant on the anticollisions current mask value and on the setting of the CRCT flag.

12.3.2 RWD receives no HITAG μ transponder IC response

During an inventory process, when the RWD has received no HITAG μ advanced/advanced+ transponder IC response, it needs to wait T_{Fp3} before sending a subsequent EOF to switch to the next slot, if a 16 slot anticollision request is processed, or sending a subsequent request (which could be again an inventory request).

T_{Fp3} starts from the time the RWD has generated the falling edge of the last sent EOF.

The minimum value of T_{Fp3} is $T_{Fp3min} = T_{Fp1max} + T_{FpSOF}$.

T_{FpSOF} is the time duration for a HITAG μ advanced/advanced+ transponder to transmit an SOF to the reader.

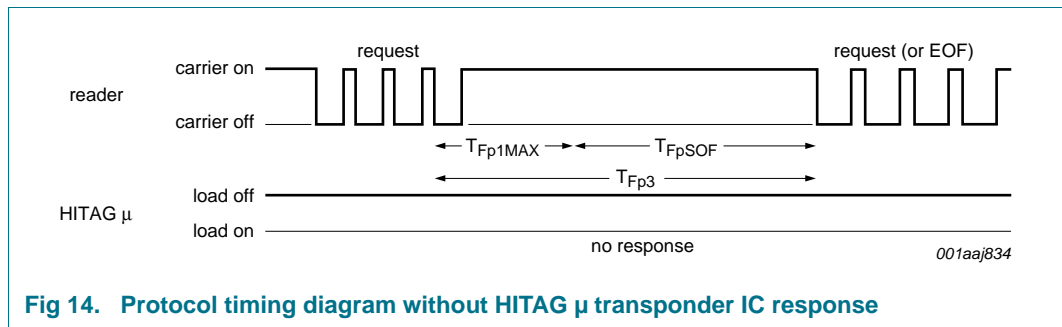

Fig 14. Protocol timing diagram without HITAG μ transponder IC response

Table 14. Overview timing parameters [1]

Symbol	Min	Max
T_{FpSOF}	$3 \times T_{Fd}$	$3 \times T_{Fd}$
T_{Fp1}	$204 \times T_C$	$213 \times T_C$
T_{Fp2}	$150 \times T_C$	-
T_{Fp3}	$T_{Fp1max} + T_{FpSOF}$	-

[1] T_C ...Carrier period time ($1/134.2$ kHz = 7.45 μ s nominal)

13. State diagram

13.1 General description of states

RF Off

The powering magnetic field is switched off or the HITAG μ transponder IC is out of the field.

WAIT

After start up phase, the HITAG μ transponder IC is ready to receive the first command.

READY

The HITAG μ transponder IC enters this state after a valid command, except of the STAY QUIET, SELECT or WRITE-ISO11785 command. If there are several HITAG μ transponder ICs at the same time in the field of the RWD antenna, the anticollision sequence can be started to determine the UID of every HITAG μ transponder IC.

SELECTED

The HITAG μ transponder IC enters the Selected state after receiving the SELECT command with a matching UID. In the Selected state the respective commands with SEL=1 are valid only for selected transponder.

Only one HITAG μ transponder IC can be selected at one time. If one transponder is selected and a second transponder receives the SELECT Command, the first transponder will automatically change to Quiet state.

QUIET

The HITAG μ transponder IC enters this state after receiving a STAY QUIET command or when he was in selected state and receives a SELECT command addressed to another transponder.

In this state, the HITAG μ transponder IC reacts to any request commandos where the ADR flag is set.

ISO 11785 STATE

In this state the HITAG μ transponder IC replies according to the ISO 11785 protocol.

Remark:

In case of an invalid command the transponder will remain in his actual state.

13.2 State diagram HITAG μ advanced/advanced+

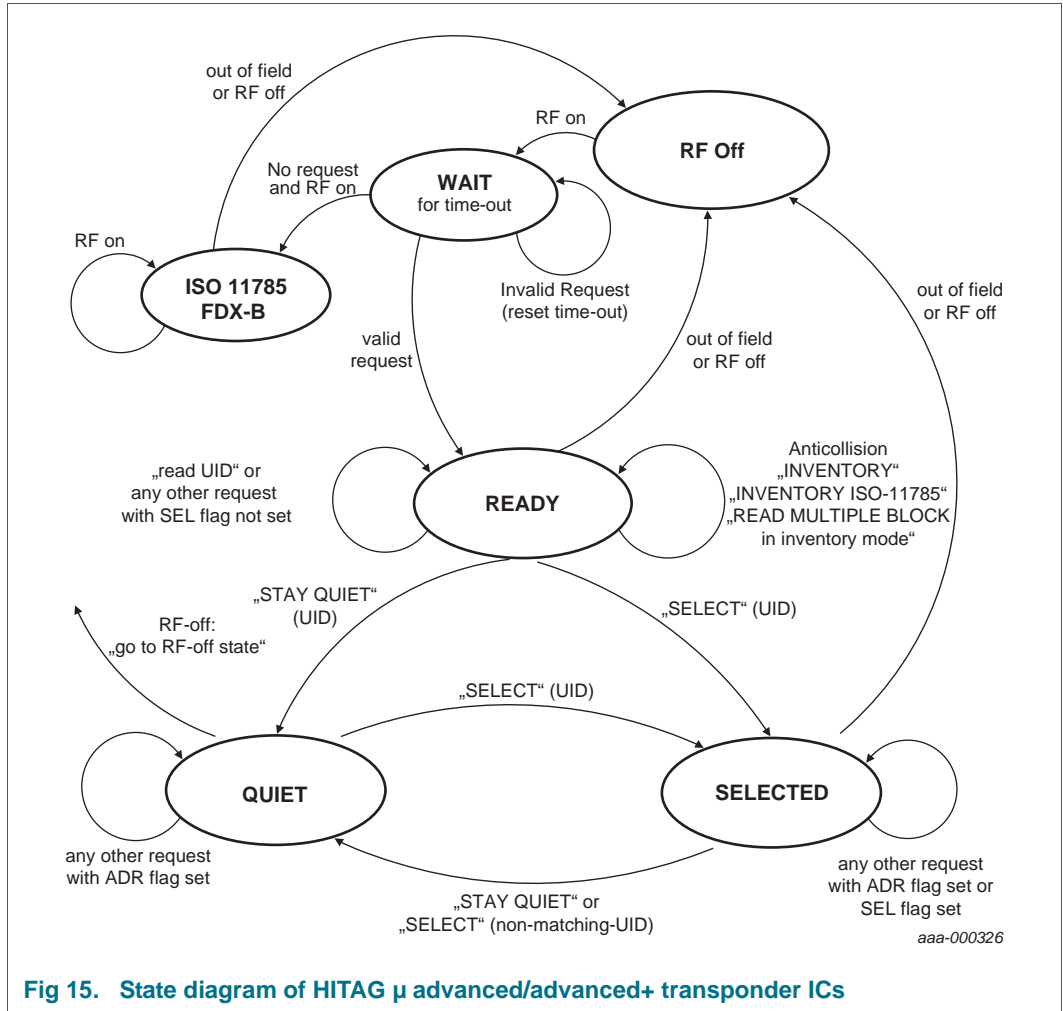

Fig 15. State diagram of HITAG μ advanced/advanced+ transponder ICs

13.3 State diagram HITAG μ

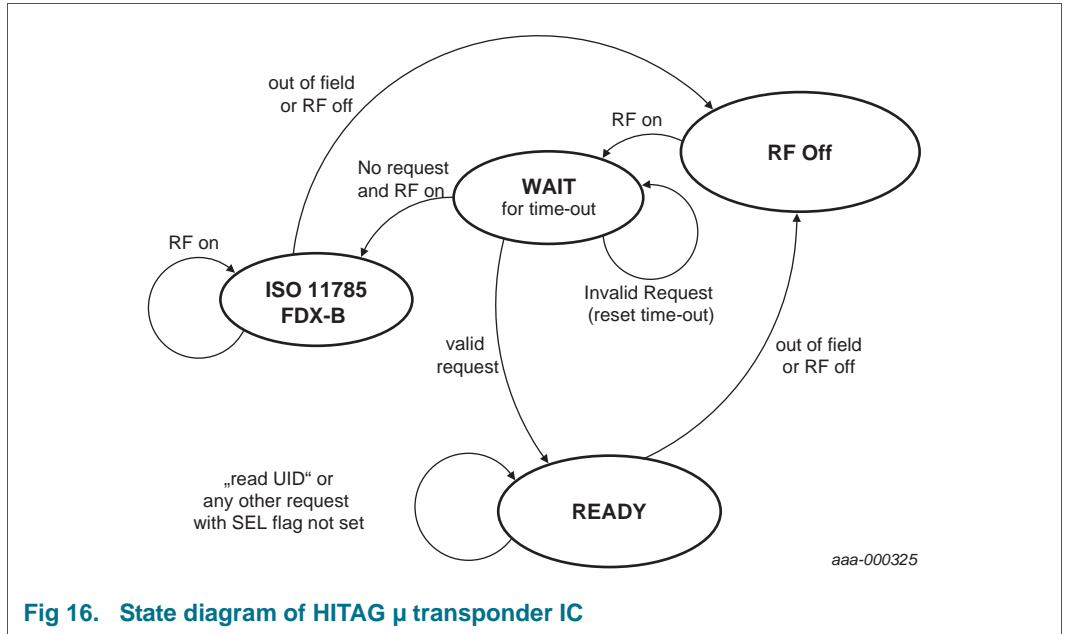

Fig 16. State diagram of HITAG μ transponder IC

13.4 Modes

13.4.1 ISO 11785 Mode

This mode is also named TTF (Transponder Talks First).

Every time a transponder IC is activated by the field it starts executing this mode. After waiting the maximum listening window time (see [Section 11.2](#)) the transponder IC sends continuously its TTF data (128-bit).

The TTF data stored in the memory will be not checked for ISO compliance, therefore data will be sent as stored in the EEPROM.

Receiving a valid command or a switch command within the listening window sets the transponder IC into RTF (Reader Talks First) mode.

13.4.2 RTF Mode

In this mode the transponder IC reacts only to RWD request commands as presented in [Section 14](#). A valid request consists of a command sent to the transponder IC being in matching state (therefore see tables in [Section 14](#) and transponder ICs state machine in [Section 13](#)).

13.4.3 Anticollision

The RWD is the master of the communication with one or multiple transponder ICs. It starts the anticollision sequence by issuing the inventory request (see [Section 14.3](#)). Within the RWD command the NOS flag must be set to the desired setting (1 or 16 slots) and add the mask length and the mask value after the command field.

The mask length n indicates the number of significant bits of the mask value. It can have any value between 0 and 44 when 16 slots are used and any value between 0 and 48 when 1 slot is used.

The next two subsections summarize the actions done by the transponder IC during an inventory round.

13.4.3.1 Anticollision with 1 slot

The transponder IC will receive one or more inventory commands with NOS = '1'. Every time the transponder ICs fractional or whole UID matches the mask value of RWD's request it responds with remaining UID without mask value.

Transponder ICs responses are modulated by dual pattern data coding as described in [Section 11.4](#).

13.4.3.2 Anticollision with 16 slots

The transponder IC will receive several inventory commands with NOS = '0' defining an amount of 16 slots. Within the request there is the mask specified by length and value (sent LSB first).

In case of mask length = '0' the four least significant bits of transponder ICs UID become the starting value of transponder IC's slot counter.

In case of mask length \neq '0' the received fractional mask is compared to transponder IC's UID. If it matches the starting value for transponder IC's slot number will be calculated. Starting at last significant bit of the sent mask the next four less significant bits of UID are used for this value. At the same time transponder IC's slot counter is reset to '0'.

Now the RWD begins its anticollision algorithm. Every time the transponder IC receives an EOF it increments slot-counter. Now if mask value and slot-counter value are matching the transponder IC responds with the remaining UID without mask value but with slot number

In case of collision within one slot the RWD changes the mask value and starts again running its algorithm.

14. Command set

The first part of this section ([Section 14.1](#)) describes the flags used in every RWD command. The following subsections ([Section 14.3](#) until [Section 14.13](#)) explain all implemented commands and their suitable transponder IC responses which are done with tables showing the command itself and suitable responses.

Within tables flags, parameter bits and parts of a response written in braces are optional. That means if the suitable flag is set resulting transponder IC's action will be performed according to [Section 14.1](#).

Every command except the Switch command is embedded in SOF and EOF pattern. As described in [Table 15](#) and [Table 16](#) sending and receiving data is done with the least significant bit of every field on first position.

Important information:

In this document the fields (i.e. command codes) are written with most significant bit first.

Table 15. Reader - Transponder IC transmission [\[1\]](#)[\[2\]](#)

SOF	Flags	Commands	Parameters	Data	CRC-16	EOF
-	5	6	var.	var.	(16)	-
-	LSB ... MSB	LSB ... MSB	LSB ... MSB	LSB ... MSB	LSB ... MSB	-

[1] values in braces are optional

[2] data is sent with least significant bit first

Table 16. Transponder IC - Reader transmission [\[1\]](#)[\[2\]](#)

SOF	Error flag	Data/Error code	CRC-16	EOF
-	1	var.	(16)	-
-	-	LSB ... MSB	LSB ... MSB	-

[1] values in braces are optional

[2] data is sent with least significant bit first

14.1 Flags

Every request command contains five flags which are sent in order Bit 1 (LSB) to Bit 5 (MSB). The specific meaning depends on the context.

Table 17. Command Flags

Bit	Flag	Full name	Value	Description
1	PEXT	Protocol EXTension	0 1	No protocol format extension RFU
2	INV	INVENTORY	0 1	Flag 4 and Flag 5 are 'SEL' and 'ADR' Flag Flag 4 and Flag 5 are 'RFU' and 'NOS' Flag
3	CRCT	CRC-Transponder	0 1	Transponder IC respond without CRC Transponder IC respond contains CRC
4	SEL (INV==0)	SElect		in combination with ADR (see Table 19)
5	ADR (INV==0)	ADdRess		in combination with SEL (see Table 19)
4	RFU (INV==1)	Reserved for future use	0	this flag is not used and set to '0'
5	NOS (INV==1)		0 1	16 slots while performing anti-collision 1 slot while performing anti-collision

Table 18. Command Flags - Bit order

	MSB bit5	bit4	bit3	bit2	LSB bit1
INV==0	ADR	SEL	CRCT	INV	PEXT
INV==1	NOS	RFU	CRCT	INV	PEXT

Table 19. Meaning of ADR and SEL flag

ADR	SEL	Meaning
0	0	Request without UID, all transponder ICs in READY state shall respond
1	0	Request contains UID, one transponder IC (with corresponding UID) shall respond
0	1	Request without UID, the transponder IC in SELECTED state shall respond
1	1	Reserved for future use

Note:

For HITAG μ inventory (INV) flag and select (SEL) flag must be set to '0'

14.2 Error handling

In case an error has been occurred the transponder IC responses with the set error flag and the three bit code '111' (meaning 'unknown error').

The general response format in case of an error response is shown in [Table 20](#) whereas commands not supporting error responses are excluded. In case of an unsupported command there will be no response. The format is embedded into SOF and EOF.

Table 20. Response format in error case

Error flag	Error code	CRC-16	Description
1	3	(16)	No. of bits
1	111		

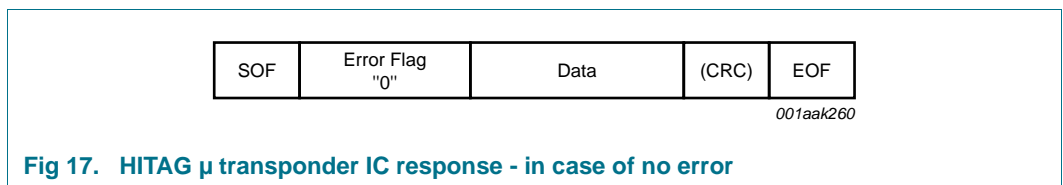

Fig 17. HITAG μ transponder IC response - in case of no error

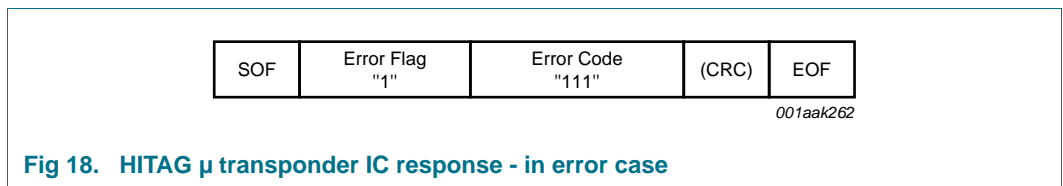

Fig 18. HITAG μ transponder IC response - in error case

14.3 INVENTORY

[Advanced, Advanced+]

Upon reception of this command without error, all transponder ICs in the ready state shall perform the anticollision sequence. The inventory (INV) flag shall be set to '1'. The NOS flag determines whether 1 or 16 slots are used.

If a transponder IC detects any error, it shall remain silent.

Table 21. INVENTORY - Request format (00h)

Flags	Command	Mask length	Mask value	CRC-16	Description
5	6	6	n	(16)	No. of bits
10(1)10	000000	$0 \leq n \leq \text{UID length}$	UID Mask		AC with 1 timeslot
00(1)10	000000	$0 \leq n \leq \text{UID length}$	UID Mask		AC with 16 timeslot

Table 22. Response to a successful INVENTORY request [1][2]

Error Flag	Data	CRC-16	Description
1	48 - n	(16)	No. of bits
0	Remaining UID without mask value		

[1] Error and CRC are Manchester coded, UID is dual pattern coded

[2] Response within the according time slot

Error Flag set to '0' indicates no error.

14.4 INVENTORY ISO 11785

[Advanced, Advanced+]

Upon reception of this command without error, all transponder ICs in the ready state are performing the anticollision sequence. The inventory (INV) flag is set to '1'. The NOS flag determines whether 1 or 16 slots are used.

In contrast to INVENTORY command the transponder IC (holding requested slot) sends the 64-bit ISO 11785 number in addition to remaining UID. The 64-bit number is taken from a fixed area of EEPROM. It will not be checked on ISO 11785 compliance before sending.

If a transponder IC detects any error, it remains silent.

Table 23. INVENTORY ISO 11785 - request format (23h)

Flags	Command	Mask length	Mask value	CRC-16	Description
5	6	6	n	(16)	No. of bits
10(1)10	100011	$0 \leq n \leq \text{UID length}$	UID Mask		AC with 1 timeslot
00(1)10	100011	$0 \leq n \leq \text{UID length}$	UID Mask		AC with 16 timeslot

Table 24. Response to a successful INVENTORY ISO 11785 request^[1]

Error Flag	Data 1	Data 2	CRC-16	Description
1	48 - n	64	(16)	No. of bits
0	Remaining UID without mask value	ISO 11785 number		

[1] Error, CRC and ISO 11785 number are Manchester coded, UID is dual pattern coded

14.5 STAY QUIET

[Advanced, Advanced+]

Upon reception of this command without error, a transponder IC in either ready state or selected state enters the quiet state and shall not send back a response.

The STAY QUIET command with both SEL and ADR flag set to '0' or both set to '1' is not allowed.

There is no response to the STAY QUIET request, even if the transponder detects an error

Table 25. STAY QUIET - request format(01h)

Flags	Command	Data	CRC-16	Description
5	6	(48)	(16)	No. of bits:
00(1)00	000001	-		without UID
11(1)00	000001	UID		with UID

14.6 READ UID

[μ , Advanced, Advanced+]

Upon reception of this command without error all transponder ICs in the ready state are sending their UID.

The addressed (ADR), the select (SEL), the inventory (INV) and the (PEXT) flag are set to '0'.

Table 26. READ UID - request format (02h)

Flags	Command	CRC-16	Description
5	6	(16)	No. of bits
00(1)00	000010		

Table 27. Response to a successful READ UID request

Error flag	Data	CRC-16	Description
1	48	(16)	No. of bits
0	UID		

Error flag set to '0' indicates no error.

14.7 READ MULTIPLE BLOCK

[μ , Advanced, Advanced+]

Upon reception of this command without error, the transponder reads the requested block(s) and sends back their value in the response. The blocks are numbered from 0 to 255.

The number of blocks in the request is one less than the number of blocks that the transponder returns in its response i.e. a value of '6' in the 'Number of blocks' field requests to read 7 blocks. A value '0' requests to read a single block.

Table 28. READ MULTIPLE BLOCKS (advanced/advanced+) - request format (12h)

Flags	Command	Data 1	Data 2	Data 3	CRC-16	Description
5	6	(48)	8	8	(16)	No. of bits
00(1)00	010010	-	First block number	Number of blocks		without UID in READY state
10(1)00	010010	UID	First block number	Number of blocks		with UID in READY state
01(1)00	010010	-	First block number	Number of blocks		without UID in SELECTED state

Table 29. READ MULTIPLE BLOCKS (μ) - request format (12h)

Flags	Command	Data 1	Data 2	Data 3	CRC-16	Description
5	6	(48)	8	8	(16)	No. of bits
00(1)00	010010	-	First block number	Number of blocks		without UID in READY state
10(1)00	010010	UID	First block number	Number of blocks		with UID in READY state

Table 30. Response to a successful READ MULTIPLE BLOCKS request

Error Flag	Data	CRC-16	Description
1	32 x Number of blocks	(16)	No. of bits
0	User memory block data		

Error Flag set to '0' indicates no error.

14.7.1 READ MULTIPLE BLOCKS in INVENTORY mode

[Advanced, Advanced+]

The READ MULTIPLE BLOCK command can also be sent in inventory mode (which is marked by INV-Flag = '1' within the request). Here request and response will change as shown in following tables.

If the transponder detects an error during the inventory sequence, it shall remain silent.

Table 31. READ MULTIPLE BLOCKS - request format (12h)

Flags	Command	Mask length	Mask value	Parameter 1	Parameter 2	CRC-16	Description
5	6	6	n	8	8	(16)	No. of bits
10(1)10	010010	$0 \leq n \leq$ UID length		First block number	Number of blocks		AC with 1 timeslot
00(1)10	010010	$0 \leq n \leq$ UID length		First block number	Number of blocks		AC with 16 timeslot

After receiving RWD's command without error the transponder IC transmits the remaining section of the UID in dual pattern code. The following data (Error Flag, Data 2, optional CRC in no error case; Error Flag, Error Code, optional CRC in error case) is transmitted in Manchester Code.

Table 32. READ MULTIPLE BLOCKS in INVENTORY mode Response format [1]

Error Flag	Data 1	Data 2	CRC-16	Description
1	48 - n	32 x number of blocks	(16)	No.of bits
0	Remaining section of UID (without mask value)	User memory block data		

[1] Error, CRC and Data are Manchester coded, UID is dual pattern coded

14.8 WRITE SINGLE BLOCK

[μ , Advanced, Advanced+]

Upon reception of this command without error, the transponder IC writes 32-bit of data into the requested user memory block and report the success of the operation in the response.

Table 33. WRITE SINGLE BLOCK (advanced/advanced+) - request format (14h)

Flags	Command	Data 1	Data 2	Data 3	CRC-16	Description
5	6	(48)	8	32	(16)	No. of bits
(1)0(1)00	010100	-	block number	block data		without UID in READY state
0(1)(1)00	010100	UID	block number	block data		with UID in READY state
01(1)00	010100	-	block number	block data		without UID in SELECTED state

Table 34. WRITE SINGLE BLOCK (μ) - request format (14h)

Flags	Command	Data 1	Data 2	Data 3	CRC-16	Description
5	6	(48)	8	32	(16)	No. of bits
00(1)00	010100	-	block number	block data		without UID in READY state
10(1)00	010100	UID	block number	block data		with UID in READY state

Table 35. Response to a successful WRITE SINGLE BLOCK request

Error Flag	CRC-16	Description
1	(16)	No. of bits
0		

Error Flag set to '0' indicates no error.

14.9 LOCK BLOCK

[μ , Advanced, Advanced+]

Upon reception of this command without error, the transponder IC is write locking the requested block (block size = 32-bit) permanently.

Blocks within the block address range from 00h to 17h as well as FEh and FFh can be locked individually.

For HITAG μ advanced+ transponder IC a LOCK BLOCK command with a block number value between 18h to 36h will lock all blocks within the block address range 18h to 36h.

In case a password is applied to the memory a lock is only possible after a successful login.

Table 36. LOCK BLOCK (advanced/advanced+) - request format (16h)

Flags	Command	Data 1	Data 2	CRC-16	Description
5	6	(48)	8	(16)	No. of bits
00(1)00	010110	-	block number		without UID in READY state
10(1)00	010110	UID	block number		with UID in READY state
01(1)00	010110	-	block number		without UID in SELECTED state

Table 37. LOCK BLOCK (μ) - request format (16h)

Flags	Command	Data 1	Data 2	CRC-16	Description
5	6	(48)	8	(16)	No. of bits
00(1)00	010110	UID	block number		without UID in READY state
10(1)00	010110	-	block number		with UID in READY state

Table 38. Response to a successful LOCK BLOCK request

Error flag	CRC-16	Description
1	(16)	No. of bits
0		

Error Flag set to '0' indicates no error.

14.10 SELECT

[Advanced, Advanced+]

The SELECT command is always be executed with SEL flag set to '0' and ADR flag set to '1'. There are several possibilities upon reception of this command without error:

- If the UID, received by the transponder IC, is equal to its own UID, the transponder IC enters the Selected state and shall send a response.
- If the received UID is different there are two possibilities
 - A transponder IC in a non-selected state (QUIET or READY) is keeping its state and not sending a response.
 - The transponder IC in the Selected state enters the Quiet state and does not send a response.

Table 39. SELECT - request format (18h)

Flags	Command	Data 1	CRC-16	Description
5	6	48	(16)	No. of bits
10(1)00	011000	UID		

Table 40. Response to a successful SELECT request

Error flag	CRC-16	Description
1	(16-bit)	No. of bits
0		

Error Flag set to '0' indicates no error.

14.11 WRITE ISO 11785 (custom command)

[μ , Advanced, Advanced+]

Upon reception of this command without error, the transponder IC (in Ready state) writes 128-bit of ISO 11785 TTF data into suitable reserved memory block and report the success of the operation in the response. The user does not have to attend whether the data is compliant to ISO 11785 or not. The command data block is sent exactly the same way as it is sent by the transponder IC in TTF mode (Header, 64-bit ID, CRC...) after entering the field again.

There are two different command codes one for locking the TTF area after successful write command and one without locking.

The command must be completed by a reset of the IC. After entering the RF field the ISO 11785 data is sent when the transponder is in ISO 11785 state.

Table 41. WRITE ISO 11785 - request format (38h, 39h)

Flags	Command	Data 1	CRC-16	Description
5	6	128	(16)	No. of bits
00(1)00	111000	ISO 11785 TTF data		
00(1)00	111001	ISO 11785 TTF data		inc. LOCK

Table 42. Response to a successful WRITE ISO 11785 request

Error flag	CRC-16	Description
1	(16)	No. of bits
0		

Error Flag set to '0' indicates no error.

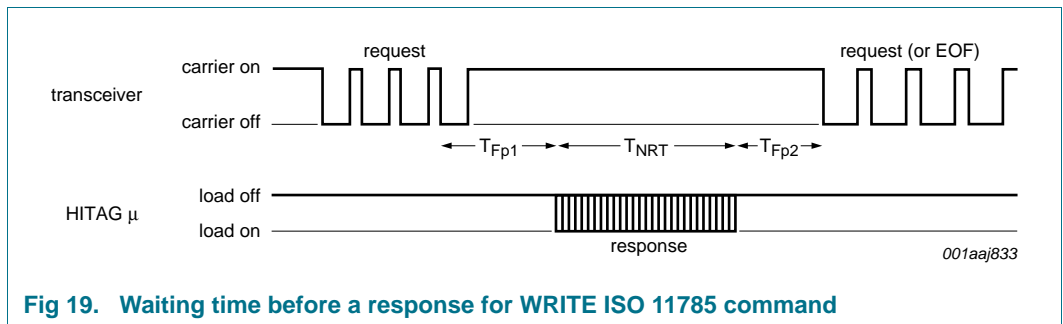

Fig 19. Waiting time before a response for WRITE ISO 11785 command

The minimum value of T_{Fp1} is 20 ms.

14.12 GET SYSTEM INFORMATION

[Advanced, Advanced+]

Upon reception of this command without error, the transponder IC reads the requested system memory block(s) and sends back their values in the response.

Table 43. GET SYSTEM INFORMATION - request format (17h)

Flags	Command	Data 1	CRC-16	Description
5	6	(48)	(16)	No. of bits
00(1)00	010111			without UID
10(1)00	010111	UID		with UID

Table 44. GET SYSTEM INFORMATION - response format

Error flag	Data									CRC-16	Description
1	40	8	8	8	8	8	8	8	8	(16)	No. of bits
0	system memory block data										
	MSN	MFC	ICR ⁽¹⁾	0	0	0	0	0	0		

[1] ICR: Hitag μ: 10h, Hitag μ advanced: 20h, Hitag μ advanced+: 30h

Error Flag set to '0' indicates no error.

14.13 LOGIN

[μ , Advanced, Advanced+]

Upon reception of this command without error, the transponder IC compares received password with PWD in memory block (FEh) and if correct it permits write (opt. read) access to the protected memory area (defined in User config, see [Table 8](#)) and reports the success of the operation in the response. In case a wrong password is issued in a further login request no access to protected memory blocks will be granted.

Default password: FFFFFFFFh

Table 45. LOGIN (advanced/advanced+) - request format

Flags	Command	IC MFC	Parameter 1	Password	CRC-16	Description
5	6	8	(48)	32	(16)	No. of bits
00(1)00	101000	MFC	-	password		without UID in READY state
10(1)00	101000	MFC	UID	password		with UID in READY state
01(1)00	101000	MFC	-	password		without UID in SELECTED state

Table 46. LOGIN (μ) - request format

Flags	Command	IC MFC	Parameter 1	Password	CRC-16	Description
5	6	8	(48)	32	(16)	No. of bits
00(1)00	101000	MFC	-	password		without UID in READY state
10(1)00	101000	MFC	UID	password		with UID in READY state

Table 47. Response to a successful LOGIN request

Error flag	CRC-16	Description
1	(16)	No. of bits
0		

15. Transponder Talks First (TTF) mode

This mode of the HITAG μ transponder enables data transmission to a RWD without sending any command. Every time the transponder IC is activated by the field it starts executing this mode.

The transponder in TTF mode sends the data stored in the EEPROM independent if the data is ISO compliant or not.

If the transponder IC is configured in TTF mode a SWITCH command or SOF sent by the RWD within the defined listening window sets the transponder into RTF mode.

16. Data integrity/calculation of CRC

The following explanations show the features of the HITAG μ protocol to protect read and write access to transponders from undetected errors. The CRC is an 16-bit CRC according to ISO 11785.

16.1 Data transmission: RWD to HITAG μ transponder IC

Data stream transmitted by the RWD to the HITAG μ transponder may include an optional 16-bit Cyclic Redundancy Check (CRC-16).

The data stream is first verified for data errors by the HITAG μ transponder IC and then executed.

The generator polynomial for the CRC-16 is:

$$u^{16} + u^{12} + u^5 + 1 = 1021h$$

The CRC pre set value is: 0000h

16.2 Data transmission: HITAG μ transponder IC to RWD

The HITAG μ transponder calculates the CRC on all received bits of the request. Whether the HITAG μ transponder IC calculated CRC is appended to the response depends on the setting of the CRCT flag.

17. Limiting values

Table 48. Limiting values^{[1][2]}

In accordance with the Absolute Maximum Rating System (IEC 60134).

Symbol	Parameter	Conditions	Min	Max	Unit
T _{stg}	storage temperature		-55	+125	°C
V _{ESD}	electrostatic discharge voltage	JEDEC JESD 22-A114-AB Human Body Model	±2	-	kV
I _{i(max)}	maximum input current	IN1-IN2	-	±20	mA
T _j	junction temperature		-40	+85	°C

- [1] Stresses above those listed under Absolute Maximum Ratings may cause permanent damage to the device. This is a stress rating only and functional operation of the device at these or any conditions other than those described in the Operating Conditions and Electrical Characteristics section of this specification is not implied.
- [2] This product includes circuitry specifically designed for the protection of its internal devices from the damaging effects of excessive static charge. Nonetheless, it is suggested that conventional precautions should be taken to avoid applying values greater than the rated maxima

18. Characteristics

Table 49. Characteristics

Symbol	Parameter	Conditions	Min	Typ	Max	Unit	
f _{oper}	operating frequency		100	125	150	kHz	
V _i	input voltage	IN1-IN2	4	5	6	V	
I _i	input current	IN1-IN2	-	-	±10	mA	
C _i	input capacitance	between IN1-IN2					
		HTMS1x01	^{[2][3]}	203.7	210	216.3	pF
		HTMS8x01	^{[2][4]}	266	280	294	pF

- [1] Typical ratings are not guaranteed. Values are at 25 °C.
- [2] Measured with an HP4285A LCR meter at 125 kHz/room temperature (25 °C); V_{IN1-IN2} = 0.5 V (RMS)
- [3] Integrated Resonance Capacitor: 210pF ±3%
- [4] Integrated Resonance Capacitor: 280pF ±5%

19. Marking

19.1 Marking SOT1122

Table 50. Marking SOT1122

Type	Type code
HTMS8001FTB/AF	80
HTMS8101FTB/AF	81
HTMS8201FTB/AF	82

Table 51. Pin description SOT1122

Pin	Description
1	IN 1
2	IN 2
3	n.c not connected

19.2 Marking HVSON2

Only two lines are available for marking (Figure 20).

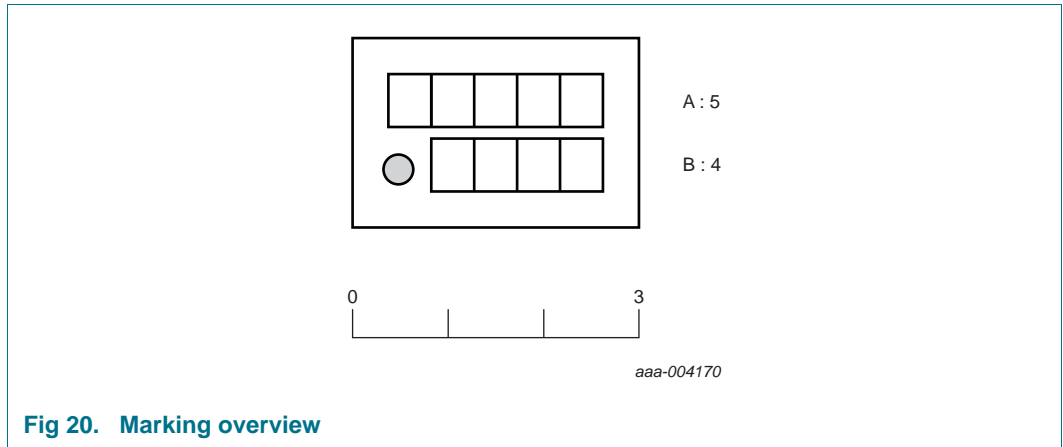

Fig 20. Marking overview

First line consists on five digits and contains the diffusion lot number. Second line consists on four digits and describes the product type, HTMS8001FTK, HTMS8101FTK or HTMS8201FTK (see example in Table 52).

Table 52. Marking example

Line	Marking	Description
A	70960	5 digits, Diffusion Lot Number, First letter truncated
B	HM80	4 digits, Type: Table 53 "Marking HVSON2"

Table 53. Marking HVSON2

Type	Type code
HTMS8001FTK/AF	HM80
HTMS8101FTK/AF	HM81
HTMS8201FTK/AF	HM82

20. Package outline

XSON3: plastic extremely thin small outline package; no leads; 3 terminals; body 1 x 1.45 x 0.5 mm

SOT1122

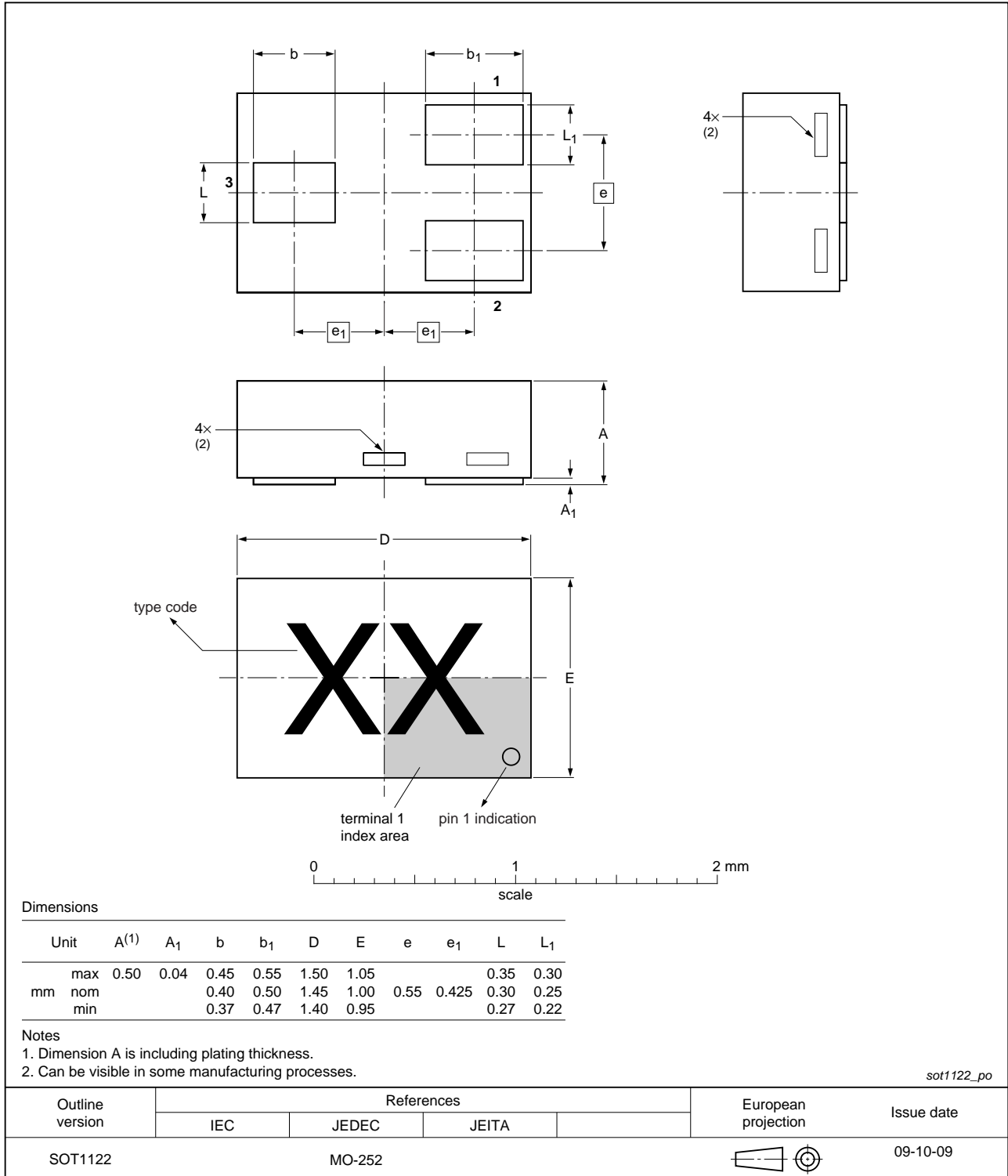

Fig 21. Package outline SOT1122

HVSON2: plastic thermal enhanced very thin small outline package; no leads;
2 terminals; body $3 \times 2 \times 0.85$ mm

SOT899-1

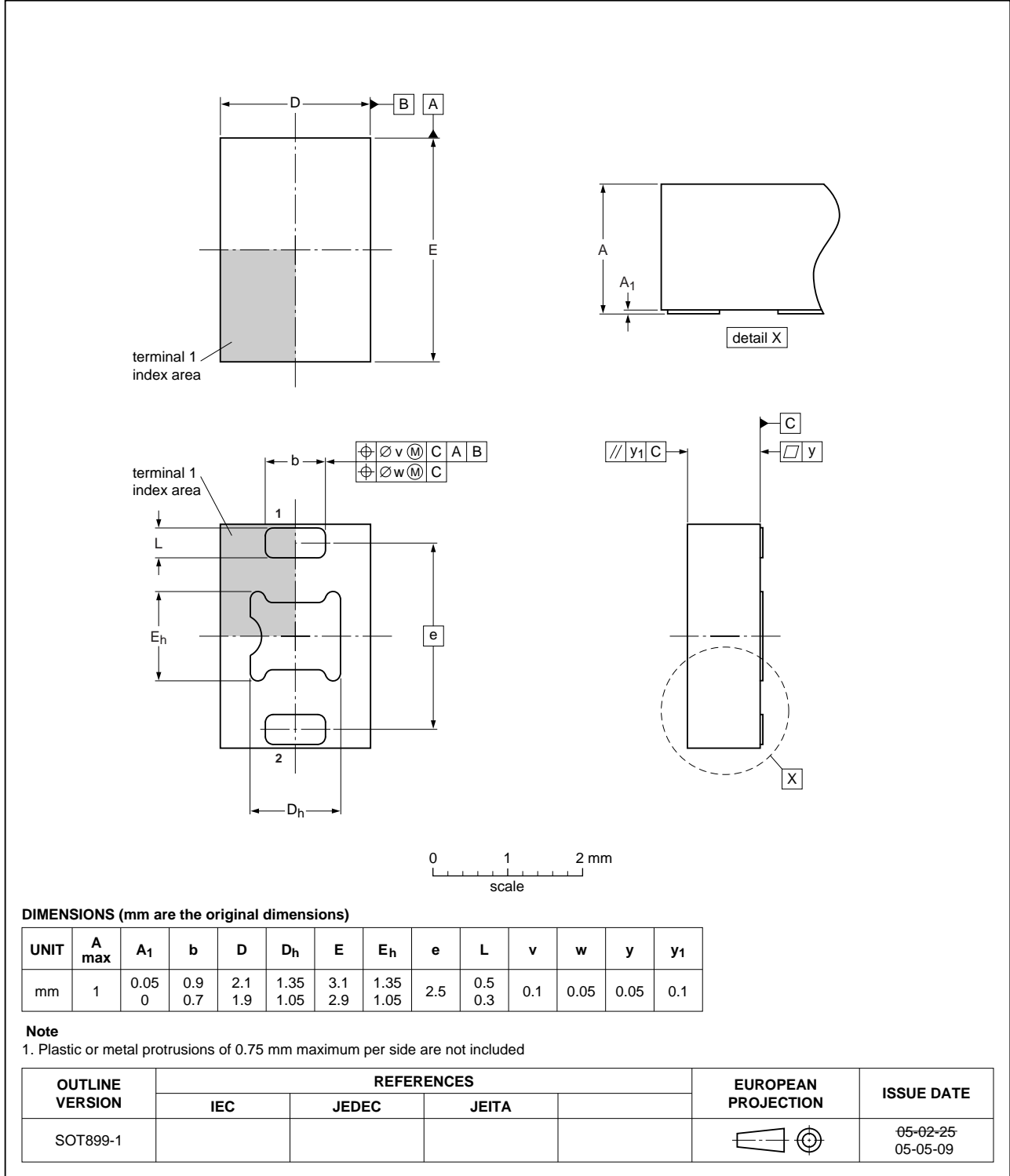

Fig 22. Package outline HVSON2

21. Abbreviations

Table 54. Abbreviations

Abbreviation	Definition
AC	Anticollision Code
ASK	Amplitude Shift Keying
BC	Bi-phase Code
BPLC	Binary Pulse Length Coding
CRC	Cyclic Redundancy Check
DSFID	Data Storage Format Identifier
EEPROM	Electrically Erasable Programmable Read-Only Memory
EOF	End Of Frame
IC	Integrated Circuit
ICR	Integrated Circuit Reference number
LSB	Least Significant Bit
LSByte	Least Significant Byte
m	Modulation Index
MC	Manchester Code
MFC	integrated circuit Manufacturer Code
MSB	Most Significant Bit
MSByte	Most Significant Byte
MSN	Manufacturer Serial Number
NA	No Access
NOB	Number Of Block
NOP	Number Of Pages
NOS	Number Of Slots
NSS	Number Of Sensors
OTP	One Time Programmable
PID	Product Identifier
PWD	Password
RF	Radio Frequency
RFU	Reserved for Future Use
RND	Random Number
RO	Read Only
RTF	Reader Talks First
R/W	Read/Write
RWD	Read Write Device
SOF	Start of Frame
TTF	Transponder Talks First
UID	Unique Identifier

22. References

- [1] **Application note** — AN10214, HITAG Coil Design Guide, Transponder IC BU-ID Doc.No.: 0814**1
- [2] **General specification for 8" wafer on UV-tape with electronic fail die marking** — Delivery type description, BU-ID Doc.No.: 1093**1

1. ** ... document version number

23. Revision history

Table 55: Revision history

Document ID	Release date	Data sheet status	Change notice	Supersedes
HTMS1x01_8x01 v. 3.4	20150521	Product data sheet	-	HTMS1x01_8x01 v. 3.3
Modifications:	<ul style="list-style-type: none"> • Section 5 "Ordering information": 210 pF product versions removed • Section 14.12 Table 44 "GET SYSTEM INFORMATION - response format": ICR codes added • Section 19.1 Table 50 "Marking SOT1122": 210 pF product versions removed • Section 19.2 Table 53 "Marking HVSON2": update and 210 pF product versions removed 			
HTMS1x01_8x01 v. 3.3	20141017	Product data sheet	-	HTMS1x01_8x01 v. 3.2
Modifications:	<ul style="list-style-type: none"> • Section 24 "Legal information": License statement "ICs with HITAG functionality" removed 			
HTMS1x01_8x01 v. 3.2	20120703	Product data sheet	-	H152931_HITAG μ
Modifications:	<ul style="list-style-type: none"> • Section 9.2 "Memory configuration": updated • Section 14.9 "LOCK BLOCK": updated • Some modifications done to comply with HTMS1x01_HTSM8x01 short data sheet 			
152931	20100114	Product data sheet		152930
Modifications:	<ul style="list-style-type: none"> • Section 6 "Ordering information": updated • Section 10 "Mechanical specification", Section 21 "Marking" and Section 22 "Package outline": added • A number of tables have been redesigned. 			
152930	20090716	Product data sheet		152912
Modifications:	<ul style="list-style-type: none"> • Section 3.6 "Delivery types": remove delivery types • Section 6 "Ordering information": remove delivery types SOT1122 and SOT732-1 • Section 15.2 "State diagram HITAG m advanced/advanced+": Note added • Section 19 "Limiting values": move input current to table 42 • Section 17 "Package outline": removed • Section 20 "Legal information": update 			
152912	20090619	Objective data sheet		152911
Modifications:	<ul style="list-style-type: none"> • General update • The drawings have been redesigned to comply with the new identity guidelines of NXP Semiconductors. 			
152911	20090225	Objective data sheet	-	152910
Modifications:	<ul style="list-style-type: none"> • General update 			
152910	20090114	Objective data sheet	-	-

24. Legal information

24.1 Data sheet status

Document status ^{[1][2]}	Product status ^[3]	Definition
Objective [short] data sheet	Development	This document contains data from the objective specification for product development.
Preliminary [short] data sheet	Qualification	This document contains data from the preliminary specification.
Product [short] data sheet	Production	This document contains the product specification.

[1] Please consult the most recently issued document before initiating or completing a design.

[2] The term 'short data sheet' is explained in section "Definitions".

[3] The product status of device(s) described in this document may have changed since this document was published and may differ in case of multiple devices. The latest product status information is available on the Internet at URL <http://www.nxp.com>.

24.2 Definitions

Draft — The document is a draft version only. The content is still under internal review and subject to formal approval, which may result in modifications or additions. NXP Semiconductors does not give any representations or warranties as to the accuracy or completeness of information included herein and shall have no liability for the consequences of use of such information.

Short data sheet — A short data sheet is an extract from a full data sheet with the same product type number(s) and title. A short data sheet is intended for quick reference only and should not be relied upon to contain detailed and full information. For detailed and full information see the relevant full data sheet, which is available on request via the local NXP Semiconductors sales office. In case of any inconsistency or conflict with the short data sheet, the full data sheet shall prevail.

Product specification — The information and data provided in a Product data sheet shall define the specification of the product as agreed between NXP Semiconductors and its customer, unless NXP Semiconductors and customer have explicitly agreed otherwise in writing. In no event however, shall an agreement be valid in which the NXP Semiconductors product is deemed to offer functions and qualities beyond those described in the Product data sheet.

24.3 Disclaimers

Limited warranty and liability — Information in this document is believed to be accurate and reliable. However, NXP Semiconductors does not give any representations or warranties, expressed or implied, as to the accuracy or completeness of such information and shall have no liability for the consequences of use of such information. NXP Semiconductors takes no responsibility for the content in this document if provided by an information source outside of NXP Semiconductors.

In no event shall NXP Semiconductors be liable for any indirect, incidental, punitive, special or consequential damages (including - without limitation - lost profits, lost savings, business interruption, costs related to the removal or replacement of any products or rework charges) whether or not such damages are based on tort (including negligence), warranty, breach of contract or any other legal theory.

Notwithstanding any damages that customer might incur for any reason whatsoever, NXP Semiconductors' aggregate and cumulative liability towards customer for the products described herein shall be limited in accordance with the *Terms and conditions of commercial sale* of NXP Semiconductors.

Right to make changes — NXP Semiconductors reserves the right to make changes to information published in this document, including without limitation specifications and product descriptions, at any time and without notice. This document supersedes and replaces all information supplied prior to the publication hereof.

Suitability for use — NXP Semiconductors products are not designed, authorized or warranted to be suitable for use in life support, life-critical or safety-critical systems or equipment, nor in applications where failure or malfunction of an NXP Semiconductors product can reasonably be expected to result in personal injury, death or severe property or environmental damage. NXP Semiconductors and its suppliers accept no liability for inclusion and/or use of NXP Semiconductors products in such equipment or applications and therefore such inclusion and/or use is at the customer's own risk.

Applications — Applications that are described herein for any of these products are for illustrative purposes only. NXP Semiconductors makes no representation or warranty that such applications will be suitable for the specified use without further testing or modification.

Customers are responsible for the design and operation of their applications and products using NXP Semiconductors products, and NXP Semiconductors accepts no liability for any assistance with applications or customer product design. It is customer's sole responsibility to determine whether the NXP Semiconductors product is suitable and fit for the customer's applications and products planned, as well as for the planned application and use of customer's third party customer(s). Customers should provide appropriate design and operating safeguards to minimize the risks associated with their applications and products.

NXP Semiconductors does not accept any liability related to any default, damage, costs or problem which is based on any weakness or default in the customer's applications or products, or the application or use by customer's third party customer(s). Customer is responsible for doing all necessary testing for the customer's applications and products using NXP Semiconductors products in order to avoid a default of the applications and the products or of the application or use by customer's third party customer(s). NXP does not accept any liability in this respect.

Limiting values — Stress above one or more limiting values (as defined in the Absolute Maximum Ratings System of IEC 60134) will cause permanent damage to the device. Limiting values are stress ratings only and (proper) operation of the device at these or any other conditions above those given in the Recommended operating conditions section (if present) or the Characteristics sections of this document is not warranted. Constant or repeated exposure to limiting values will permanently and irreversibly affect the quality and reliability of the device.

Terms and conditions of commercial sale — NXP Semiconductors products are sold subject to the general terms and conditions of commercial sale, as published at <http://www.nxp.com/profile/terms>, unless otherwise agreed in a valid written individual agreement. In case an individual agreement is concluded only the terms and conditions of the respective agreement shall apply. NXP Semiconductors hereby expressly objects to applying the customer's general terms and conditions with regard to the purchase of NXP Semiconductors products by customer.

No offer to sell or license — Nothing in this document may be interpreted or construed as an offer to sell products that is open for acceptance or the grant, conveyance or implication of any license under any copyrights, patents or other industrial or intellectual property rights.

Export control — This document as well as the item(s) described herein may be subject to export control regulations. Export might require a prior authorization from competent authorities.

Quick reference data — The Quick reference data is an extract of the product data given in the Limiting values and Characteristics sections of this document, and as such is not complete, exhaustive or legally binding.

Non-automotive qualified products — Unless this data sheet expressly states that this specific NXP Semiconductors product is automotive qualified, the product is not suitable for automotive use. It is neither qualified nor tested in accordance with automotive testing or application requirements. NXP Semiconductors accepts no liability for inclusion and/or use of non-automotive qualified products in automotive equipment or applications.

In the event that customer uses the product for design-in and use in automotive applications to automotive specifications and standards, customer (a) shall use the product without NXP Semiconductors' warranty of the

product for such automotive applications, use and specifications, and (b) whenever customer uses the product for automotive applications beyond NXP Semiconductors' specifications such use shall be solely at customer's own risk, and (c) customer fully indemnifies NXP Semiconductors for any liability, damages or failed product claims resulting from customer design and use of the product for automotive applications beyond NXP Semiconductors' standard warranty and NXP Semiconductors' product specifications.

24.4 Trademarks

Notice: All referenced brands, product names, service names and trademarks are the property of their respective owners.

HITAG — is a trademark of NXP Semiconductors N.V.

25. Contact information

For more information, please visit: <http://www.nxp.com>

For sales office addresses, please send an email to: salesaddresses@nxp.com

26. Contents

1	General description	1	12.1	Waiting time before transmitting a response after an EOF from the RWD	23
1.1	Target markets	1	12.2	RWD waiting time before sending a subsequent request	24
1.1.1	Animal identification	1	12.3	RWD waiting time before switching to next inventory slot	24
1.1.2	Laundry automation	1	12.3.1	RWD started to receive one or more HITAG μ transponder IC responses	24
1.1.3	Beer keg and gas cylinder logistic	2	12.3.2	RWD receives no HITAG μ transponder IC response	25
1.1.4	Brand protection	2	13	State diagram	26
2	Features and benefits	2	13.1	General description of states	26
2.1	Features	2	13.2	State diagram HITAG m advanced/advanced+	27
2.2	Protocol	2	13.3	State diagram HITAG m	28
2.3	Memory	2	13.4	Modes	29
2.4	Supported standards	2	13.4.1	ISO 11785 Mode	29
2.5	Security features	3	13.4.2	RTF Mode	29
2.6	Delivery types	3	13.4.3	Anticollision	29
3	Applications	3	13.4.3.1	Anticollision with 1 slot	29
4	Quick reference data	3	13.4.3.2	Anticollision with 16 slots	30
5	Ordering information	4	14	Command set	31
6	Block diagram	5	14.1	Flags	32
7	Pinning information	6	14.2	Error handling	33
8	Mechanical specification	8	14.3	INVENTORY	34
8.1	Wafer specification	8		[Advanced, Advanced+]	34
8.1.1	Fail die identification	9	14.4	INVENTORY ISO 11785	35
8.1.2	Map file distribution	9		[Advanced, Advanced+]	35
9	Functional description	10	14.5	STAY QUIET	35
9.1	Memory organization	10		[Advanced, Advanced+]	35
9.1.1	Memory organization HITAG m transponder ICs	10	14.6	READ UID	36
9.1.2	Memory organization HITAG μ Advanced	11		[m, Advanced, Advanced+]	36
9.1.3	Memory organization HITAG μ Advanced +	12	14.7	READ MULTIPLE BLOCK	37
9.2	Memory configuration	13		[m, Advanced, Advanced+]	37
10	General requirements	14	14.7.1	READ MULTIPLE BLOCKS in INVENTORY mode	38
11	HITAG m transponder IC air interface	14		[Advanced, Advanced+]	38
11.1	Downlink description	14	14.8	WRITE SINGLE BLOCK	39
11.2	Mode switching protocol	16		[m, Advanced, Advanced+]	39
11.2.1	SWITCH	17	14.9	LOCK BLOCK	40
11.3	Downlink communication signal interface - RWD to HITAG μ transponder IC	18		[m, Advanced, Advanced+]	40
11.3.1	Modulation parameters	18	14.10	SELECT	41
11.3.2	Data rate and data coding	19		[Advanced, Advanced+]	41
11.3.3	RWD - Start of frame pattern	20	14.11	WRITE ISO 11785 (custom command)	42
11.3.4	RWD - End of frame pattern	20		[m, Advanced, Advanced+]	42
11.4	Communication signal interface - HITAG μ transponder IC to RWD	21	14.12	GET SYSTEM INFORMATION	43
11.4.1	Data rate and data coding	21		[Advanced, Advanced+]	43
11.4.2	Start of frame pattern	22	14.13	LOGIN	44
11.4.3	End of frame pattern	22			
12	General protocol timing specification	23			

continued >>

	[m, Advanced, Advanced+].	44
15	Transponder Talks First (TTF) mode	45
16	Data integrity/calculation of CRC	45
16.1	Data transmission: RWD to HITAG μ transponder IC	45
16.2	Data transmission: HITAG μ transponder IC to RWD	45
17	Limiting values.	46
18	Characteristics.	46
19	Marking.	47
19.1	Marking SOT1122.	47
19.2	Marking HVSON2.	48
20	Package outline	49
21	Abbreviations.	51
22	References	52
23	Revision history.	53
24	Legal information.	54
24.1	Data sheet status	54
24.2	Definitions	54
24.3	Disclaimers	54
24.4	Trademarks.	55
25	Contact information.	55
26	Contents	56

Please be aware that important notices concerning this document and the product(s) described herein, have been included in section 'Legal information'.

© NXP Semiconductors N.V. 2015. All rights reserved.

For more information, please visit: <http://www.nxp.com>
 For sales office addresses, please send an email to: salesaddresses@nxp.com

Date of release: 21 May 2015
152934