

NTNS31315NZ

Small Signal MOSFET

20 V, 220 mA, Single N-Channel, XDFN3
0.62 x 0.42 x 0.4 mm Package

Features

- Low Profile Ultra Small Package, XDFN3 (0.62 x 0.42 x 0.4 mm) for Extremely Space-Constrained Applications
- 1.5 V Gate Drive
- These Devices are Pb-Free, Halogen Free/BFR Free and are RoHS Compliant

Applications

- Small Signal Load Switch
- High Speed Interfacing
- Level Shift

MAXIMUM RATINGS (T_J = 25°C unless otherwise stated)

Parameter		Symbol	Value	Unit	
Drain-to-Source Voltage		V _{DSS}	20	V	
Gate-to-Source Voltage		V _{GS}	±8	V	
Continuous Drain Current (Note 1)	Steady State	I _D	T _A = 25°C	220	mA
			T _A = 85°C	158	
	t ≤ 5 s	T _A = 25°C	253		
Power Dissipation (Note 1)	Steady State	P _D	T _A = 25°C	125	mW
			t ≤ 5 s	166	
Pulsed Drain Current	t _p = 10 μs	I _{DM}	846	mA	
Operating Junction and Storage Temperature		T _J , T _{STG}	-55 to 150	°C	
Source Current (Body Diode) (Note 2)		I _S	200	mA	
Lead Temperature for Soldering Purposes (1/8" from case for 10 s)		T _L	260	°C	

Stresses exceeding those listed in the Maximum Ratings table may damage the device. If any of these limits are exceeded, device functionality should not be assumed, damage may occur and reliability may be affected.

1. Surface-mounted on FR4 board using the minimum recommended pad size, or 2 mm², 1 oz Cu.
2. Pulse Test: pulse width ≤ 300 μs, duty cycle ≤ 2%



ON Semiconductor®

www.onsemi.com

V _{(BR)DSS}	R _{DS(on)} MAX	I _D Max
20 V	1.5 Ω @ 4.5 V	220 mA
	1.8 Ω @ 3.3 V	
	2.2 Ω @ 2.5 V	
	3.3 Ω @ 1.8 V	
	5.0 Ω @ 1.5 V	

N-CHANNEL MOSFET

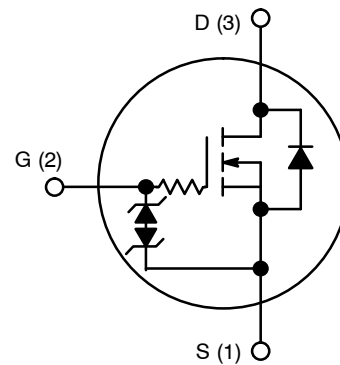

MARKING DIAGRAM



XDFN3
CASE 711BH



A = Specific Device Code
M = Date Code

ORDERING INFORMATION

Device	Package	Shipping†
NTNS31315NZTCG	XDFN3 (Pb-Free)	8000 / Tape & Reel

†For information on tape and reel specifications, including part orientation and tape sizes, please refer to our Tape and Reel Packaging Specification Brochure, BRD8011/D.

NTNS31315NZ

THERMAL RESISTANCE RATINGS

Parameter	Symbol	Max	Unit
Junction-to-Ambient – Steady State (Note 3)	$R_{\theta JA}$	998	°C/W
Junction-to-Ambient – $t \leq 5$ s (Note 3)	$R_{\theta JA}$	751	

3. Surface-mounted on FR4 board using the minimum recommended pad size, or 2 mm², 1 oz Cu.

ELECTRICAL CHARACTERISTICS ($T_J = 25^\circ\text{C}$ unless otherwise stated)

Parameter	Symbol	Test Condition	Min	Typ	Max	Unit
-----------	--------	----------------	-----	-----	-----	------

OFF CHARACTERISTICS

Drain-to-Source Breakdown Voltage	$V_{(BR)DSS}$	$V_{GS} = 0$ V, $I_D = 250$ μ A	20			V
Zero Gate Voltage Drain Current	I_{DSS}	$V_{GS} = 0$ V, $V_{DS} = 5$ V, $T_J = 25^\circ\text{C}$			50	nA
Zero Gate Voltage Drain Current	I_{DSS}	$V_{GS} = 0$ V, $V_{DS} = 16$ V, $T_J = 25^\circ\text{C}$			100	nA
Gate-to-Source Leakage Current	I_{GSS}	$V_{DS} = 0$ V, $V_{GS} = \pm 5$ V			± 100	nA

ON CHARACTERISTICS (Note 4)

Gate Threshold Voltage	$V_{GS(TH)}$	$V_{GS} = V_{DS}$, $I_D = 250$ μ A	0.4		1.0	V
Drain-to-Source On Resistance	$R_{DS(on)}$	$V_{GS} = 4.5$ V, $I_D = 100$ mA		0.8	1.5	Ω
		$V_{GS} = 3.3$ V, $I_D = 100$ mA		1.0	1.8	
		$V_{GS} = 2.5$ V, $I_D = 50$ mA		1.1	2.0	
		$V_{GS} = 1.8$ V, $I_D = 20$ mA		1.4	3.0	
		$V_{GS} = 1.5$ V, $I_D = 10$ mA		1.8	4.5	
Forward Transconductance	g_{FS}	$V_{DS} = 5$ V, $I_D = 125$ mA		0.48		S
Source-Drain Diode Voltage	V_{SD}	$V_{GS} = 0$ V, $I_S = 10$ mA		0.6	1.0	V

CHARGES & CAPACITANCES

Input Capacitance	C_{ISS}	$V_{GS} = 0$ V, freq = 1 MHz, $V_{DS} = 15$ V		12.3		pF
Output Capacitance	C_{OSS}			3.4		
Reverse Transfer Capacitance	C_{RSS}			2.5		

SWITCHING CHARACTERISTICS, $V_{GS} = 4.5$ V (Note 4)

Turn-On Delay Time	$t_{d(ON)}$	$V_{GS} = 4.5$ V, $V_{DD} = 15$ V, $I_D = 200$ mA, $R_G = 2$ Ω		16.5		ns
Rise Time	t_r			25.5		
Turn-Off Delay Time	$t_{d(OFF)}$			142		
Fall Time	t_f			80		

4. Switching characteristics are independent of operating junction temperatures

NTNS31315NZ

TYPICAL CHARACTERISTICS

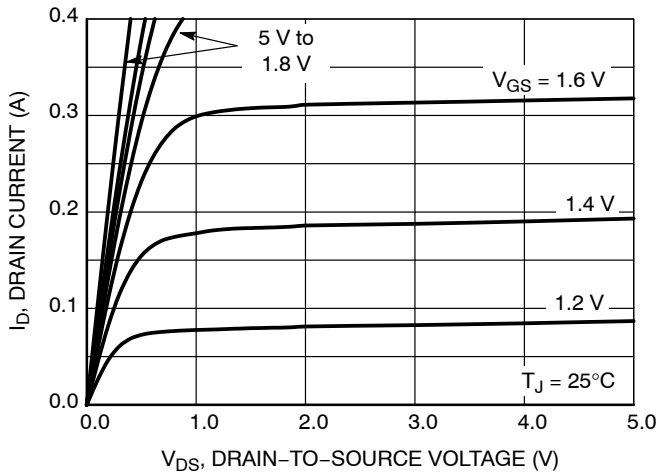

Figure 1. On-Region Characteristics

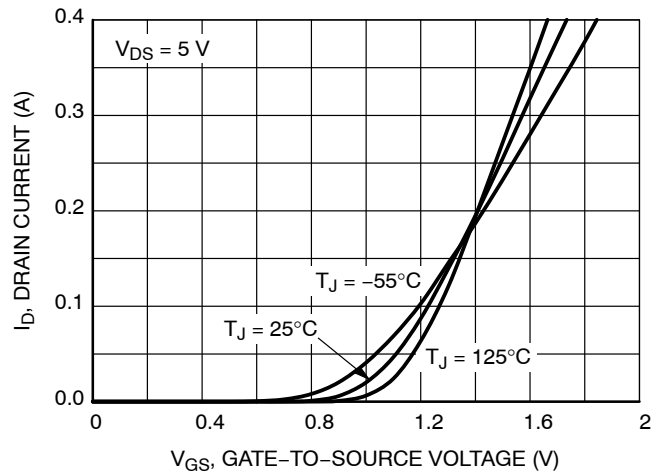

Figure 2. Transfer Characteristics

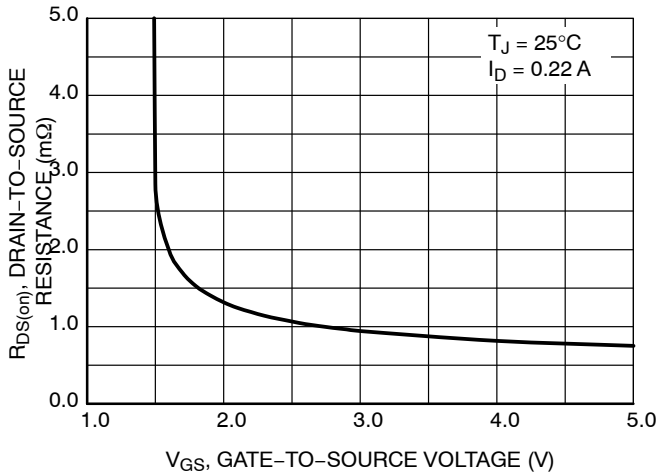

Figure 3. On-Resistance vs. Gate-to-Source Voltage

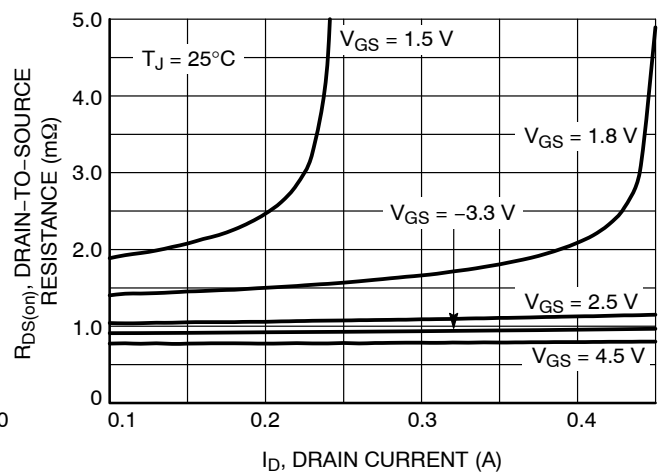

Figure 4. On-Resistance vs. Drain Current and Gate Voltage

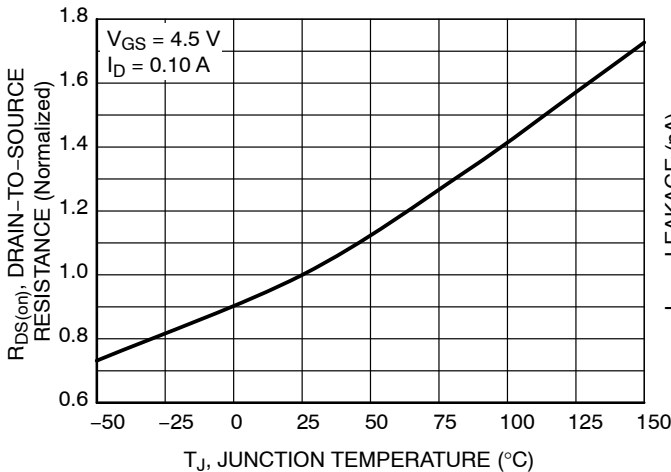

Figure 5. On-Resistance Variation with Temperature

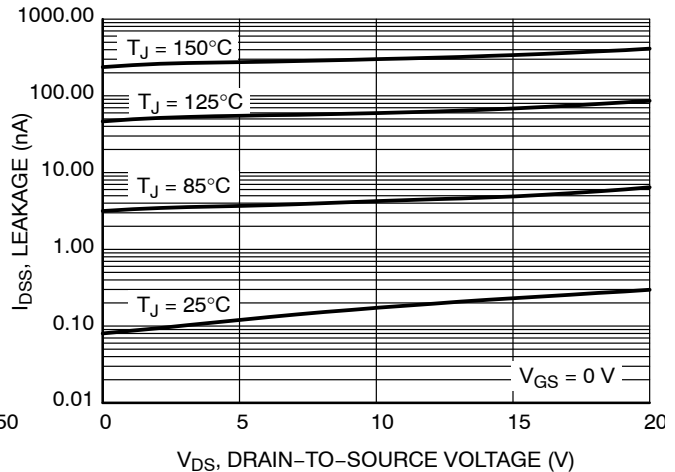

Figure 6. Drain-to-Source Leakage Current vs. Voltage

NTNS31315NZ

TYPICAL CHARACTERISTICS

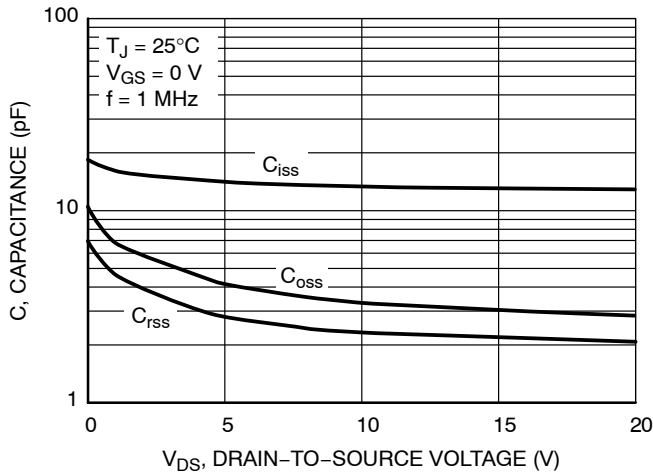

Figure 7. Capacitance Variation

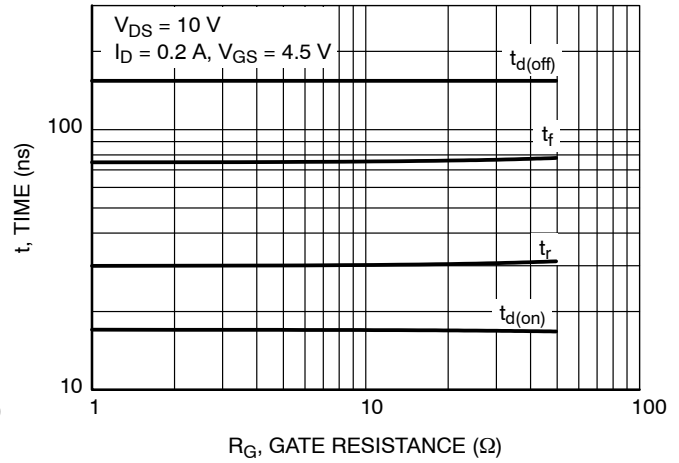

Figure 8. Resistive Switching Time Variation vs. Gate Resistance

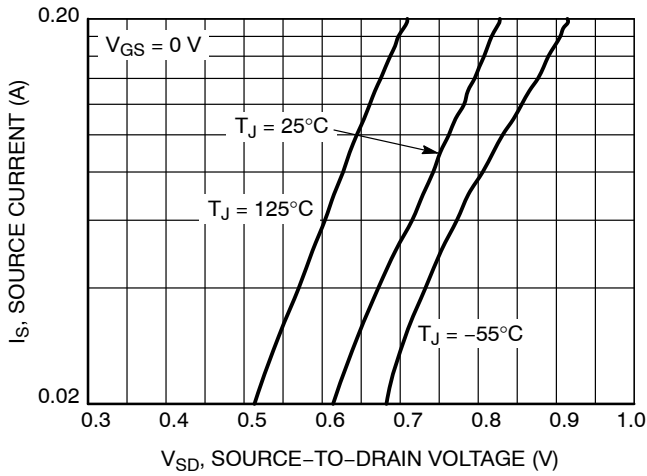

Figure 9. Diode Forward Voltage vs. Current

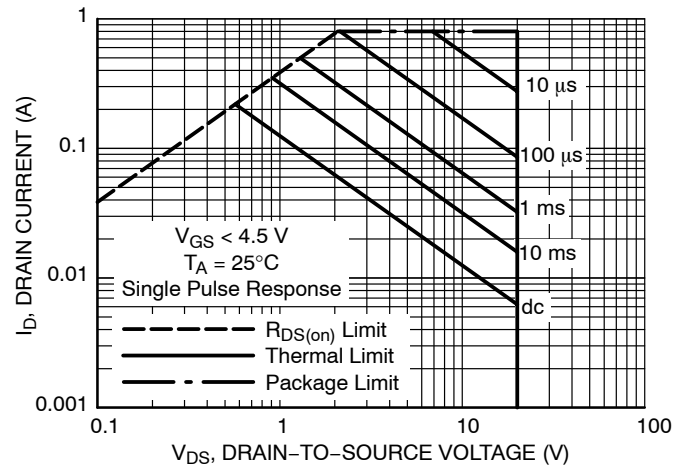

Figure 10. Maximum Rated Forward Biased Safe Operating Area

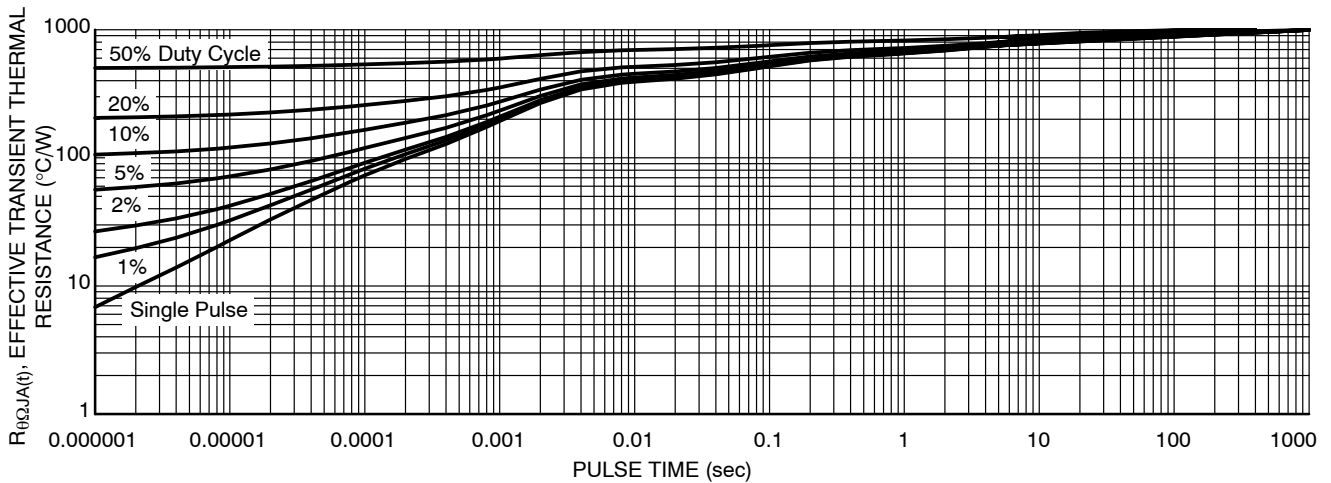
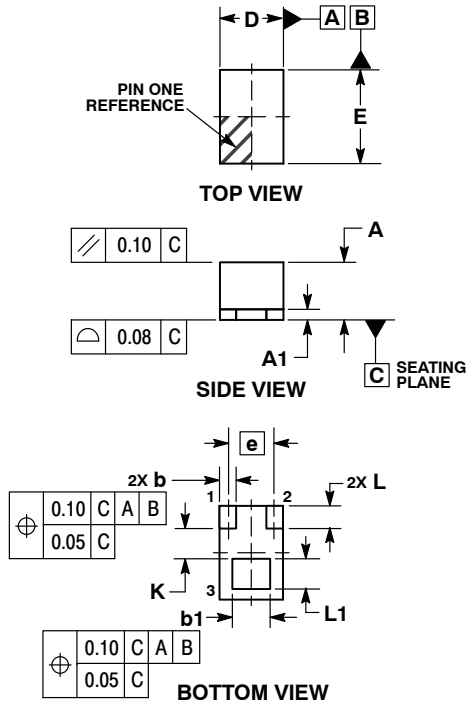

Figure 11. Thermal Response

NTNS31315NZ

PACKAGE DIMENSIONS

XDFN3 0.42x0.62, 0.3P
CASE 711BH
ISSUE O



NOTES:

1. DIMENSIONING AND TOLERANCING PER ASME Y14.5M, 1994.
2. CONTROLLING DIMENSION: MILLIMETERS.
3. DIMENSION b AND b1 APPLIES TO THE PLATED TERMINALS AND IS MEASURED BETWEEN 0.20 AND 0.25MM FROM THE TERMINAL TIP.
4. COPLANARITY APPLIES TO THE PLATED TERMINALS.

MILLIMETERS			
DIM	MIN	NOM	MAX
A	0.33	0.38	0.43
A1	---	---	0.07
b	0.05	0.11	0.17
b1	0.20	0.25	0.30
D	0.32	0.42	0.52
E	0.52	0.62	0.72
e	0.30 BSC		
L	0.09	0.15	0.21
L1	0.15	0.20	0.25
K	0.20 REF		

RECOMMENDED SOLDER FOOTPRINT*

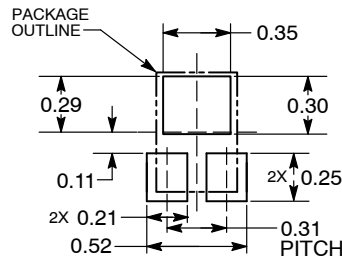

DIMENSIONS: MILLIMETERS

*For additional information on our Pb-Free strategy and soldering details, please download the ON Semiconductor Soldering and Mounting Techniques Reference Manual, SOLDERRM/D.

ON Semiconductor and are trademarks of Semiconductor Components Industries, LLC dba ON Semiconductor or its subsidiaries in the United States and/or other countries. ON Semiconductor owns the rights to a number of patents, trademarks, copyrights, trade secrets, and other intellectual property. A listing of ON Semiconductor's product/patent coverage may be accessed at www.onsemi.com/site/pdf/Patent-Marking.pdf. ON Semiconductor reserves the right to make changes without further notice to any products herein. ON Semiconductor makes no warranty, representation or guarantee regarding the suitability of its products for any particular purpose, nor does ON Semiconductor assume any liability arising out of the application or use of any product or circuit, and specifically disclaims any and all liability, including without limitation special, consequential or incidental damages. Buyer is responsible for its products and applications using ON Semiconductor products, including compliance with all laws, regulations and safety requirements or standards, regardless of any support or applications information provided by ON Semiconductor. "Typical" parameters which may be provided in ON Semiconductor data sheets and/or specifications can and do vary in different applications and actual performance may vary over time. All operating parameters, including "Typicals" must be validated for each customer application by customer's technical experts. ON Semiconductor does not convey any license under its patent rights nor the rights of others. ON Semiconductor products are not designed, intended, or authorized for use as a critical component in life support systems or any FDA Class 3 medical devices or medical devices with a same or similar classification in a foreign jurisdiction or any devices intended for implantation in the human body. Should Buyer purchase or use ON Semiconductor products for any such unintended or unauthorized application, Buyer shall indemnify and hold ON Semiconductor and its officers, employees, subsidiaries, affiliates, and distributors harmless against all claims, costs, damages, and expenses, and reasonable attorney fees arising out of, directly or indirectly, any claim of personal injury or death associated with such unintended or unauthorized use, even if such claim alleges that ON Semiconductor was negligent regarding the design or manufacture of the part. ON Semiconductor is an Equal Opportunity/Affirmative Action Employer. This literature is subject to all applicable copyright laws and is not for resale in any manner.

PUBLICATION ORDERING INFORMATION

LITERATURE FULFILLMENT:
 Literature Distribution Center for ON Semiconductor
 19521 E. 32nd Pkwy, Aurora, Colorado 80011 USA
Phone: 303-675-2175 or 800-344-3860 Toll Free USA/Canada
Fax: 303-675-2176 or 800-344-3867 Toll Free USA/Canada
Email: orderlit@onsemi.com

N. American Technical Support: 800-282-9855 Toll Free
 USA/Canada
Europe, Middle East and Africa Technical Support:
 Phone: 421 33 790 2910

ON Semiconductor Website: www.onsemi.com
Order Literature: <http://www.onsemi.com/orderlit>

For additional information, please contact your local Sales Representative