

NTZD5110N

MOSFET – Dual, N-Channel with ESD Protection, Small Signal, SOT-563 60 V, 310 mA

Features

- Low $R_{DS(on)}$ Improving System Efficiency
- Low Threshold Voltage
- ESD Protected Gate
- Small Footprint 1.6 x 1.6 mm
- These are Pb-Free Devices

Applications

- Load/Power Switches
- Driver Circuits: Relays, Lamps, Displays, Memories, etc.
- Battery Management/Battery Operated Systems
- Cell Phones, Digital Cameras, PDAs, Pagers, etc.

MAXIMUM RATINGS ($T_J = 25^\circ\text{C}$ unless otherwise noted.)

Parameter		Symbol	Value	Unit	
Drain-to-Source Voltage		V_{DS}	60	V	
Gate-to-Source Voltage		V_{GS}	± 20	V	
Continuous Drain Current (Note 1)	Steady State	I_D	$T_A = 25^\circ\text{C}$	294	mA
			$T_A = 85^\circ\text{C}$	212	
Power Dissipation (Note 1)	Steady State	P_D	250	mW	
Continuous Drain Current (Note 1)	$t \leq 5 \text{ s}$	I_D	$T_A = 25^\circ\text{C}$	310	mA
			$T_A = 85^\circ\text{C}$	225	
Power Dissipation (Note 1)	$t \leq 5 \text{ s}$	P_D	280	mW	
Pulsed Drain Current	$t_p = 10 \mu\text{s}$	I_{DM}	590	mA	
Operating Junction and Storage Temperature		T_J, T_{STG}	-55 to 150	$^\circ\text{C}$	
Source Current (Body Diode)		I_S	350	mA	
Lead Temperature for Soldering Purposes (1/8" from case for 10 s)		T_L	260	$^\circ\text{C}$	
Gate-Source ESD Rating (HBM, Method 3015)		ESD	1800	V	

THERMAL RESISTANCE RATINGS

Parameter	Symbol	Max	Unit
Junction-to-Ambient – Steady State (Note 1)	$R_{\theta JA}$	500	$^\circ\text{C/W}$
Junction-to-Ambient – $t \leq 5 \text{ s}$ (Note 1)		447	

Stresses exceeding those listed in the Maximum Ratings table may damage the device. If any of these limits are exceeded, device functionality should not be assumed, damage may occur and reliability may be affected.

1. Surface mounted on FR4 board using 1 in sq pad size (Cu. area = 1.127 in sq [1 oz] including traces).



ON Semiconductor®

<http://onsemi.com>

$V_{(BR)DSS}$	$R_{DS(on)}$ MAX	I_D Max
60	1.6 Ω @ 10 V	310 mA
	2.5 Ω @ 4.5 V	

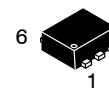
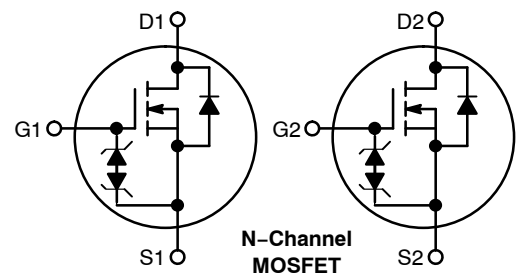

SOT-563
CASE 463A

MARKING DIAGRAM



S7 = Specific Device Code
M = Date Code

(Note: Microdot may be in either location)

PINOUT: SOT-563

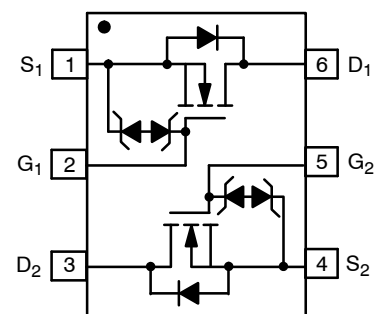

Top View

ORDERING INFORMATION

See detailed ordering and shipping information in the package dimensions section on page 4 of this data sheet.

NTZD5110N

ELECTRICAL CHARACTERISTICS ($T_J = 25^\circ\text{C}$ unless otherwise noted.)

Parameter	Symbol	Test Condition	Min	Typ	Max	Unit	
OFF CHARACTERISTICS							
Drain-to-Source Breakdown Voltage	$V_{(BR)DSS}$	$V_{GS} = 0\text{ V}, I_D = 250\ \mu\text{A}$	60	-	-	V	
Drain-to-Source Breakdown Voltage Temperature Coefficient	$V_{(BR)DSS}/T_J$	-	-	71	-	mV/°C	
Zero Gate Voltage Drain Current	I_{DSS}	$V_{GS} = 0\text{ V}$ $V_{DS} = 60\text{ V}$	$T_J = 25^\circ\text{C}$	-	-	1.0	μA
			$T_J = 125^\circ\text{C}$	-	-	500	
		$V_{GS} = 0\text{ V}$ $V_{DS} = 50\text{ V}$	$T_J = 25^\circ\text{C}$	-	-	100	nA
			$T_J = 85^\circ\text{C}$	-	-	100	
Gate-to-Source Leakage Current	I_{GSS}	$V_{DS} = 0\text{ V}, V_{GS} = \pm 20\text{ V}$	-	-	± 10	μA	
		$V_{DS} = 0\text{ V}, V_{GS} = \pm 10\text{ V}$	-	-	450	nA	
		$V_{DS} = 0\text{ V}, V_{GS} = \pm 5.0\text{ V}$	-	-	150	nA	

ON CHARACTERISTICS (Note 3)

Gate Threshold Voltage	$V_{GS(TH)}$	$V_{GS} = V_{DS}, I_D = 250\ \mu\text{A}$	1.0	-	2.5	V
Negative Threshold Temperature Coefficient	$V_{GS(TH)}/T_J$	-	-	4.0	-	mV/°C
Drain-to-Source On Resistance	$R_{DS(on)}$	$V_{GS} = 10\text{ V}, I_D = 500\text{ mA}$	-	1.19	1.6	Ω
		$V_{GS} = 4.5\text{ V}, I_D = 200\text{ mA}$	-	1.33	2.5	
Forward Transconductance	g_{FS}	$V_{DS} = 5.0\text{ V}, I_D = 200\text{ mA}$	-	80	-	S

CHARGES AND CAPACITANCES

Input Capacitance	C_{ISS}	$V_{GS} = 0\text{ V}, f = 1.0\text{ MHz},$ $V_{DS} = 20\text{ V}$	-	24.5	-	pF
Output Capacitance	C_{OSS}		-	4.2	-	
Reverse Transfer Capacitance	C_{RSS}		-	2.2	-	
Total Gate Charge	$Q_{G(TOT)}$	$V_{GS} = 4.5\text{ V}, V_{DS} = 10\text{ V};$ $I_D = 200\text{ mA}$	-	0.7	-	nC
Threshold Gate Charge	$Q_{G(TH)}$		-	0.1	-	
Gate-to-Source Charge	Q_{GS}		-	0.3	-	
Gate-to-Drain Charge	Q_{GD}		-	0.1	-	

SWITCHING CHARACTERISTICS (Note 4)

Turn-On Delay Time	$t_{d(ON)}$	$V_{GS} = 10\text{ V}, V_{DD} = 30\text{ V},$ $I_D = 200\text{ mA}, R_G = 10\ \Omega$	-	12	-	ns
Rise Time	t_r		-	7.3	-	
Turn-Off Delay Time	$t_{d(OFF)}$		-	63.7	-	
Fall Time	t_f		-	30.6	-	

DRAIN-SOURCE DIODE CHARACTERISTICS

Forward Diode Voltage	V_{SD}	$V_{GS} = 0\text{ V},$ $I_S = 200\text{ mA}$	$T_J = 25^\circ\text{C}$	-	0.8	1.2	V
			$T_J = 85^\circ\text{C}$	-	0.7	-	

Product parametric performance is indicated in the Electrical Characteristics for the listed test conditions, unless otherwise noted. Product performance may not be indicated by the Electrical Characteristics if operated under different conditions.

- Surface-mounted on FR4 board using 1 in. sq. pad size (Cu. area = 1.127 in sq [1 oz] including traces).
- Pulse Test: pulse width $\leq 300\ \mu\text{s}$, duty cycle $\leq 2\%$.
- Switching characteristics are independent of operating junction temperatures.

TYPICAL CHARACTERISTICS

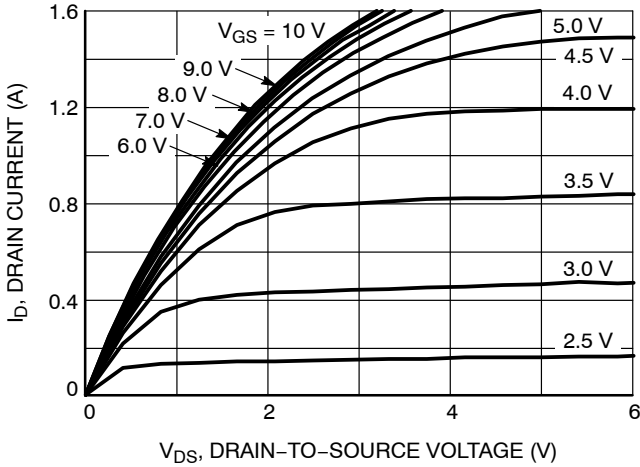

Figure 1. On-Region Characteristics

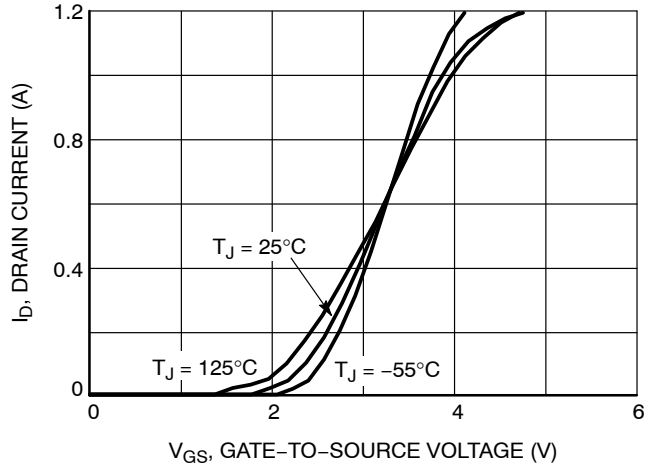

Figure 2. Transfer Characteristics

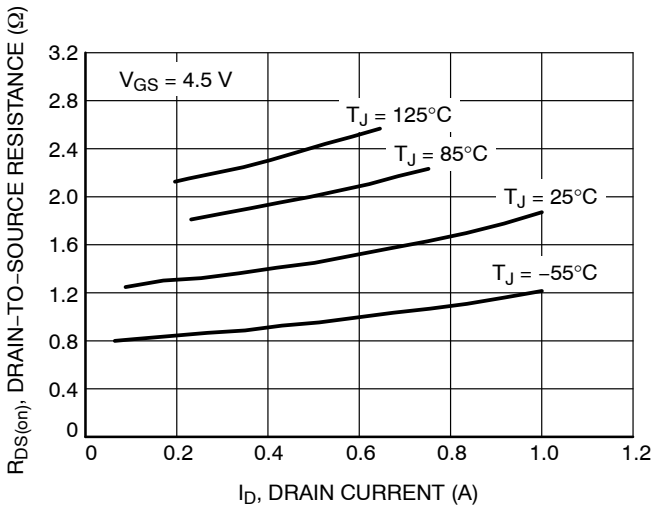

Figure 3. On-Resistance vs. Drain Current and Temperature

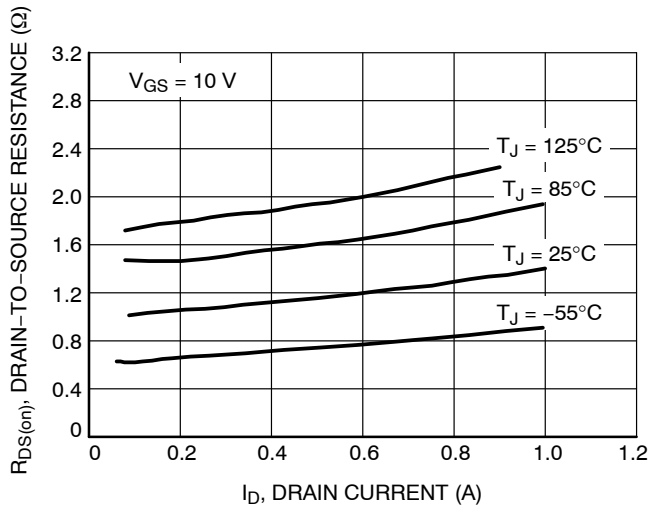

Figure 4. On-Resistance vs. Drain Current and Temperature

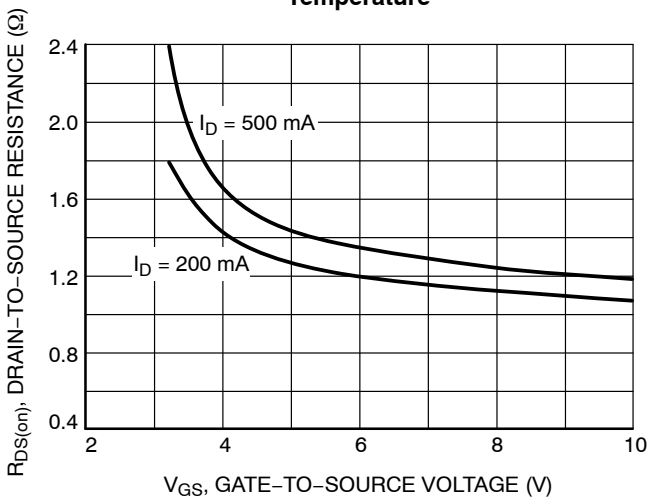

Figure 5. On-Resistance vs. Gate-to-Source Voltage

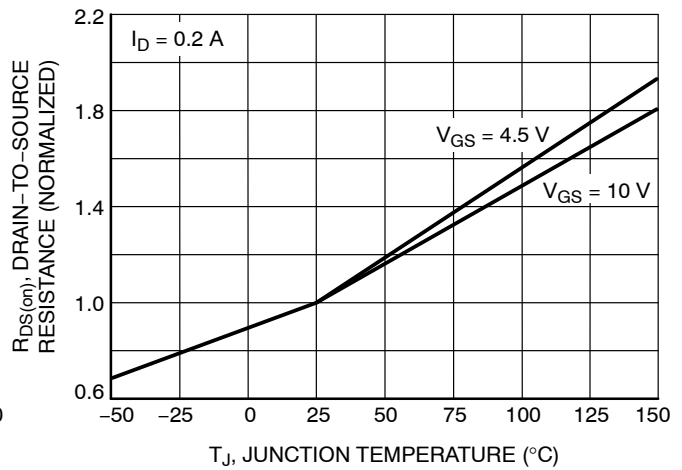

Figure 6. On-Resistance Variation with Temperature

NTZD5110N

TYPICAL CHARACTERISTICS

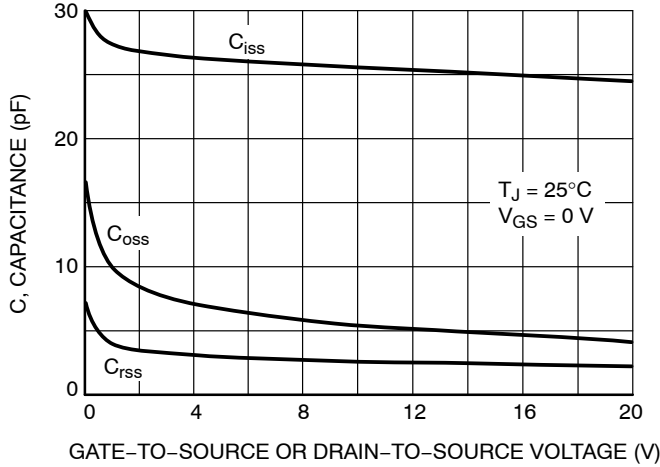

Figure 7. Capacitance Variation

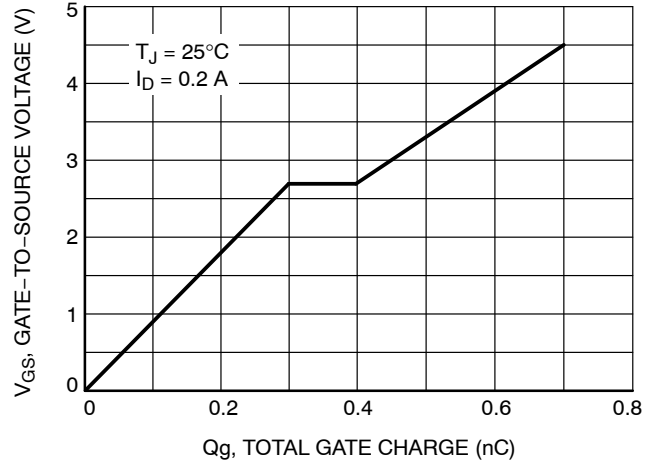

Figure 8. Gate-to-Source and Drain-to-Source Voltage vs. Total Charge

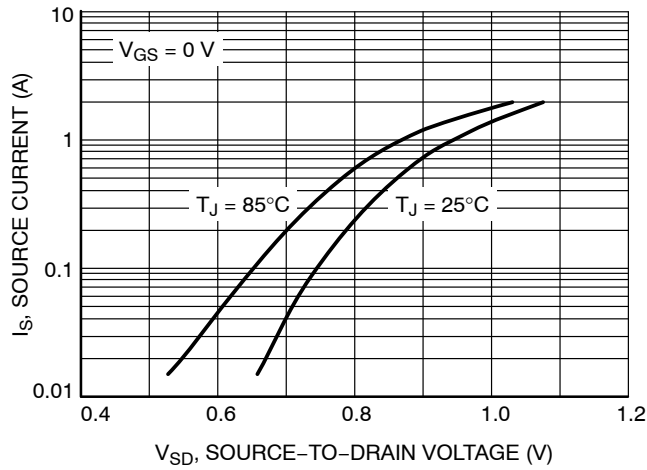

Figure 9. Diode Forward Voltage vs. Current

ORDERING INFORMATION

Device	Package	Shipping
NTZD5110NT1G	SOT-563 (Pb-Free)	4000 / Tape & Reel
NTZD5110NT5G	SOT-563 (Pb-Free)	8000 / Tape & Reel

†For information on tape and reel specifications, including part orientation and tape sizes, please refer to our Tape and Reel Packaging Specifications Brochure, BRD8011/D.

MECHANICAL CASE OUTLINE

PACKAGE DIMENSIONS

ON Semiconductor®



SCALE 4:1

SOT-563, 6 LEAD
CASE 463A
ISSUE H

DATE 26 JAN 2021

NOTES:

1. DIMENSIONING AND TOLERANCING PER ASME Y14.5M, 2009.
2. CONTROLLING DIMENSION: MILLIMETERS
3. MAXIMUM LEAD THICKNESS INCLUDES LEAD FINISH THICKNESS. MINIMUM LEAD THICKNESS IS THE MINIMUM THICKNESS OF BASE MATERIAL.



DIM	MILLIMETERS		
	MIN.	NOM.	MAX.
A	0.50	0.55	0.60
b	0.17	0.22	0.27
c	0.08	0.13	0.18
D	1.50	1.60	1.70
E	1.10	1.20	1.30
e	0.50 BSC		
L	0.10	0.20	0.30
H _E	1.50	1.60	1.70

RECOMMENDED MOUNTING FOOTPRINT*

* For additional information on our Pb-Free strategy and soldering details, please download the ON Semiconductor Soldering and Mounting Techniques Reference Manual, SOLDERRM/D.

DOCUMENT NUMBER:	98AON11126D	Electronic versions are uncontrolled except when accessed directly from the Document Repository. Printed versions are uncontrolled except when stamped "CONTROLLED COPY" in red.
DESCRIPTION:	SOT-563, 6 LEAD	PAGE 1 OF 2

ON Semiconductor and are trademarks of Semiconductor Components Industries, LLC dba ON Semiconductor or its subsidiaries in the United States and/or other countries. ON Semiconductor reserves the right to make changes without further notice to any products herein. ON Semiconductor makes no warranty, representation or guarantee regarding the suitability of its products for any particular purpose, nor does ON Semiconductor assume any liability arising out of the application or use of any product or circuit, and specifically disclaims any and all liability, including without limitation special, consequential or incidental damages. ON Semiconductor does not convey any license under its patent rights nor the rights of others.

SOT-563, 6 LEAD
CASE 463A
ISSUE H

DATE 26 JAN 2021

STYLE 1:
PIN 1. EMITTER 1
2. BASE 1
3. COLLECTOR 2
4. EMITTER 2
5. BASE 2
6. COLLECTOR 1

STYLE 2:
PIN 1. EMITTER 1
2. EMITTER 2
3. BASE 2
4. COLLECTOR 2
5. BASE 1
6. COLLECTOR 1

STYLE 3:
PIN 1. CATHODE 1
2. CATHODE 1
3. ANODE/ANODE 2
4. CATHODE 2
5. CATHODE 2
6. ANODE/ANODE 1

STYLE 4:
PIN 1. COLLECTOR
2. COLLECTOR
3. BASE
4. EMITTER
5. COLLECTOR
6. COLLECTOR

STYLE 5:
PIN 1. CATHODE
2. CATHODE
3. ANODE
4. ANODE
5. CATHODE
6. CATHODE

STYLE 6:
PIN 1. CATHODE
2. ANODE
3. CATHODE
4. CATHODE
5. CATHODE
6. CATHODE

STYLE 7:
PIN 1. CATHODE
2. ANODE
3. CATHODE
4. CATHODE
5. ANODE
6. CATHODE

STYLE 8:
PIN 1. DRAIN
2. DRAIN
3. GATE
4. SOURCE
5. DRAIN
6. DRAIN

STYLE 9:
PIN 1. SOURCE 1
2. GATE 1
3. DRAIN 2
4. SOURCE 2
5. GATE 2
6. DRAIN 1

STYLE 10:
PIN 1. CATHODE 1
2. N/C
3. CATHODE 2
4. ANODE 2
5. N/C
6. ANODE 1

STYLE 11:
PIN 1. EMITTER 2
2. BASE 2
3. COLLECTOR 1
4. EMITTER 1
5. BASE 1
6. COLLECTOR 2

**GENERIC
MARKING DIAGRAM***



XX = Specific Device Code
M = Month Code
■ = Pb-Free Package

*This information is generic. Please refer to device data sheet for actual part marking. Pb-Free indicator, "G" or microdot "■", may or may not be present. Some products may not follow the Generic Marking.

DOCUMENT NUMBER:	98AON11126D	Electronic versions are uncontrolled except when accessed directly from the Document Repository. Printed versions are uncontrolled except when stamped "CONTROLLED COPY" in red.
DESCRIPTION:	SOT-563, 6 LEAD	PAGE 2 OF 2

ON Semiconductor and are trademarks of Semiconductor Components Industries, LLC dba ON Semiconductor or its subsidiaries in the United States and/or other countries. ON Semiconductor reserves the right to make changes without further notice to any products herein. ON Semiconductor makes no warranty, representation or guarantee regarding the suitability of its products for any particular purpose, nor does ON Semiconductor assume any liability arising out of the application or use of any product or circuit, and specifically disclaims any and all liability, including without limitation special, consequential or incidental damages. ON Semiconductor does not convey any license under its patent rights nor the rights of others.

onsemi, **Onsemi**, and other names, marks, and brands are registered and/or common law trademarks of Semiconductor Components Industries, LLC dba "**onsemi**" or its affiliates and/or subsidiaries in the United States and/or other countries. **onsemi** owns the rights to a number of patents, trademarks, copyrights, trade secrets, and other intellectual property. A listing of **onsemi**'s product/patent coverage may be accessed at www.onsemi.com/site/pdf/Patent-Marking.pdf. **onsemi** reserves the right to make changes at any time to any products or information herein, without notice. The information herein is provided "as-is" and **onsemi** makes no warranty, representation or guarantee regarding the accuracy of the information, product features, availability, functionality, or suitability of its products for any particular purpose, nor does **onsemi** assume any liability arising out of the application or use of any product or circuit, and specifically disclaims any and all liability, including without limitation special, consequential or incidental damages. Buyer is responsible for its products and applications using **onsemi** products, including compliance with all laws, regulations and safety requirements or standards, regardless of any support or applications information provided by **onsemi**. "Typical" parameters which may be provided in **onsemi** data sheets and/or specifications can and do vary in different applications and actual performance may vary over time. All operating parameters, including "Typicals" must be validated for each customer application by customer's technical experts. **onsemi** does not convey any license under any of its intellectual property rights nor the rights of others. **onsemi** products are not designed, intended, or authorized for use as a critical component in life support systems or any FDA Class 3 medical devices or medical devices with a same or similar classification in a foreign jurisdiction or any devices intended for implantation in the human body. Should Buyer purchase or use **onsemi** products for any such unintended or unauthorized application, Buyer shall indemnify and hold **onsemi** and its officers, employees, subsidiaries, affiliates, and distributors harmless against all claims, costs, damages, and expenses, and reasonable attorney fees arising out of, directly or indirectly, any claim of personal injury or death associated with such unintended or unauthorized use, even if such claim alleges that **onsemi** was negligent regarding the design or manufacture of the part. **onsemi** is an Equal Opportunity/Affirmative Action Employer. This literature is subject to all applicable copyright laws and is not for resale in any manner.

PUBLICATION ORDERING INFORMATION

LITERATURE FULFILLMENT:

Email Requests to: orderlit@onsemi.com

onsemi Website: www.onsemi.com

TECHNICAL SUPPORT

North American Technical Support:

Voice Mail: 1 800-282-9855 Toll Free USA/Canada

Phone: 011 421 33 790 2910

Europe, Middle East and Africa Technical Support:

Phone: 00421 33 790 2910

For additional information, please contact your local Sales Representative

