

Rad-Hard 2 x 20 A - 150 V Schottky rectifier

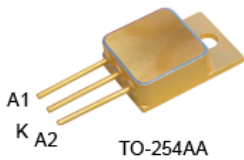

The TO-254-AA is a metallic package.
It is not connected to any pin nor to the inside die.

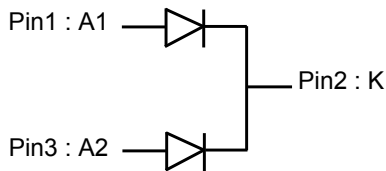

Features

- Forward current: 2 x 20 A
- Repetitive peak voltage: 150 V
- Low forward voltage drop: 0.79 V max. at 40 A / 125°
- dV/dt up to 10 kV/μs
- Monolithic dual die - common cathode
- Hermetic package
- TID immune up to 3 Mrad(Si)
- SEB immune at 61.2 MeV.cm² / mg
- Package mass: 9.4 g
- ESCC qualified : 5106/024

Description

The **STPS40A150CHR** is package and screened to comply with the ESCC5000 specification for aerospace products. It is a dual monolithic Schottky rectifier assembled in an TO-254AA hermetic package and characterized in total dose at high dose rate and in single event effect to be used in aerospace applications. It is ESCC qualified.

The complete ESCC specification for this device will be available from the European Space Agency web site. ST will guarantee full compliance of qualified parts with the ESCC detailed specification.

Product status link

[STPS40A150CHR](#)

Product summary

I_{F(AV)}	2 x 20 A
V_{RRM}	150 V
T_{j(max)}	175 °C
V_{F(max)} at 2 x 20 A / 125 °C	0.79 V

1 Characteristics

1.1 Absolute maximum ratings

The absolute maximum ratings are limiting values at 25°C, per diode unless otherwise notified. Values provided in Table 1 shall not be exceeded at any time during use or storage

Table 1. Absolute maximum ratings

Symbol	Parameter	Value	Unit
V_{RRM}	Repetitive peak reverse voltage	150	V
$I_O^{(1)(2)}$	Average output rectified current	20	A
	per diode	40	
$I_{FSM}^{(3)}$	Forward surge current	220	A
	per package		
$dV/dt^{(4)}$	Reverse voltage maximum rise rate	10	kV/ μ s
T_{op}	Operating temperature range (case temperature)	-65 to +175	°C
$T_j^{(5)}$	Maximum junction temperature	+175	°C
T_{stg}	Storage temperature range	-65 to +175	°C
$T_{sol}^{(6)}$	Soldering temperature	+245	°C
ESD	Electrostatic discharge - Human body model	8	kV

1. Per diode: at $T_{case} > +99^\circ\text{C}$, derate linearly to 0A at +175°C. Per package: at $T_{case} > +126^\circ\text{C}$, derate linearly to 0A at +175°C.
2. Each diode of the pair can be used up to 40 A provided the total current complies with the 40 A absolute maximum rating of the TO-254AA.
3. Pulse duration : $t_p = 10$ ms sinusoidal
4. Guaranteed by design, characterization and test at 25°C of 10 parts per wafer lot.
5. $(dP_{tot}/dT_j) < (1/R_{th(j-a)})$ condition to avoid thermal runaway for a diode on its own heatsink.
6. Duration 5 seconds maximum with at least 3 minutes between consecutive temperature peaks.

1.2 Thermal parameters

Table 2. Thermal parameters

Symbol	Parameter	Typ. value	Max. value	Unit	
$R_{th(j-c)}$	Thermal resistance, junction to case ⁽¹⁾	Per diode	-	1.8	°C/W
		Per package	-	1.3	

1. When only 1 diode is used, the dissipation is made from a part of the die, hence to a higher thermal resistance.

1.3 Electrical characteristics

Limiting value per diodes, unless otherwise specified.

Table 3. Static electrical characteristics

Symbol	Parameter	MIL-STD-750 test method	Test conditions ⁽¹⁾		Min.	Typ.	Max.	Unit	
I_R	Reverse leakage current	4016	DC method, $V_R = 150$ V	$T_j = 25$ °C	-	1.3	14	μ A	
				$T_j = 125$ °C	-	1.8	8	mA	
V_F ⁽²⁾⁽³⁾	Forward voltage drop	4011	$I_F = 5$ A	$T_j = -55$ °C	-	0.775	0.840	V	
				$T_j = 25$ °C	-	0.706	0.780		
				$T_j = 125$ °C	-	0.560	0.620		
				$I_F = 10$ A	$T_j = -55$ °C	-	0.940		1.040
					$T_j = 25$ °C	-	0.775		0.850
					$T_j = 125$ °C	-	0.625		0.700
			$I_F = 20$ A	$T_j = -55$ °C	-	1.300	1.455		
				$T_j = 25$ °C	-	0.855	0.940		
				$T_j = 125$ °C	-	0.710	0.790		
			$I_F = 30$ A	$T_j = -55$ °C	-	1.675	1.890		
				$T_j = 25$ °C	-	0.910	1.000		
				$T_j = 125$ °C	-	0.775	0.850		
$I_F = 40$ A	$T_j = -55$ °C	-	2.090	2.370					
	$T_j = 25$ °C	-	0.965	1.050					
	$T_j = 125$ °C	-	0.830	0.910					

1. Measurement per diode.
2. Pulse width 680 μ s, duty cycle \leq 2%
3. Each diode of the pair can be used up to 40 A provided the total current complies with the 40 A absolute maximum rating of the TO-254AA.

Table 4. Dynamic electrical characteristics

Symbol	Parameter	MIL-STD-750 test method	Test conditions		Min.	Typ.	Max.	Unit
C ⁽¹⁾	Junction capacitance	4001	$T_j = 25$ °C	$V_R = 10$ V, $F = 1$ MHz	-	-	310	pF

1. Guaranteed by sampling. In case the sampling acceptance criteria is not met, guaranteed by a 100% test.

1.4 Characteristics (curves)

Figure 1. Average forward current versus case temperature (DC, per diode)

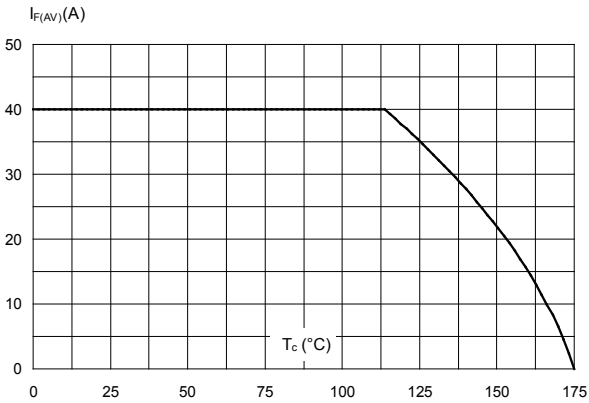

Figure 2. Forward voltage drop versus forward current (typical values, per diode)

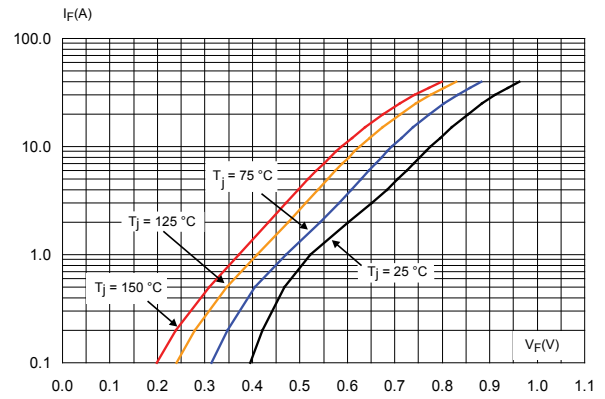

Figure 3. Reverse leakage current versus reverse voltage (typical values, per diode)

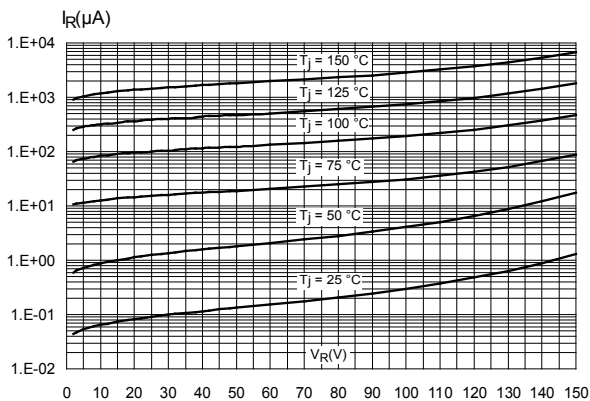

Figure 4. Relative variation of $Z_{th(j-c)}$ versus pulse duration

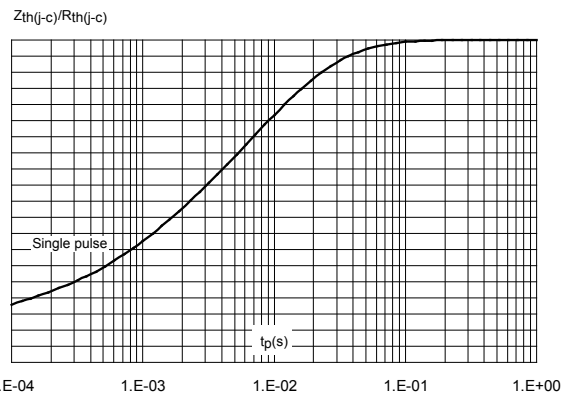
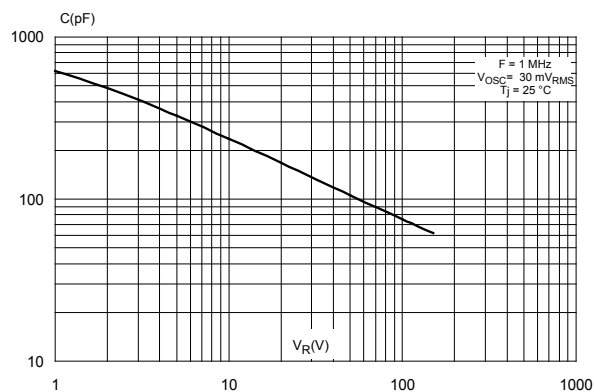

Figure 5. Junction capacitance versus reverse voltage (typical values, per diode)



2 Radiation

The technology of the STMicroelectronics Rad-Hard rectifier's diodes is intrinsically highly resistant to radiative environments.

The product radiation hardness assurance is supported by a total ionisation dose (TID) test at high dose rate and a single effect event (SEE) characterization.

2.1 Total dose radiation (TID) testing

A characterization in Total Ionizing Dose has been done at high dose rate on 12 parts housed in SMD1, 4 parts unbiased, 4 parts reverse biased and 4 parts forward biased.

The irradiation has been done according to the ESCC 22900 specification, standard window.

Both pre-irradiation and post-irradiation performances have been tested using the same circuitry and test conditions for a direct comparison can be done ($T_{amb} = 22 \pm 3 \text{ }^\circ\text{C}$ unless otherwise specified).

The following parameters were measured :

- Before irradiation
- After irradiation at final dose 3 Mrad (Si)
- After 168 hrs at room temperature
- after 168 hrs at 100 °C anneal

Based on this characterization, the device is deemed able to sustain 3 Mrad(Si) while maintaining all its parameters within its specifications.

2.2 Single event effect

The Single Event Effect (SEE) relevant to power rectifiers are characterized, i.e. the Single Event Burnout (SEB). The tests are performed as per ESCC 25100, each one on 3 pieces from 1 wafer at room temperature.

The accept/reject criteria are :

- SEB (Destructive mode):
The diode is reverse biased during irradiation. The test is stopped as soon as a SEB occurs or when the reverse leakage current is above the specification or when the overall fluency on the component reaches $1\text{E}7 \text{ cm}^2$.
- Post irradiation stress test (PIST):
After the irradiation, a stress is applied to the diode in order to reveal any latent damage on the irradiated devices.
The reverse voltage value is increased from 0 V to 100% of V_{Rmax} . and then decreased from 100% of the V_{Rmax} . to 0 V. At each step, the reverse leakage current value is measured.

Table 5. Radiation hardness assurance summary

Type	Conditions	Result
Total ionisation dose	High dose rate 4 reverse biased + 4 forward biased + 4 unbiased	Immune up to 3 Mrad(Si)
Single effect burnout	LET 61.2 MeV.cm ² /mg, $V_r \leq 66\% V_{rrm}$	No burnout

3 Package information

In order to meet environmental requirements, ST offers these devices in different grades of **ECOPACK** packages, depending on their level of environmental compliance. ECOPACK specifications, grade definitions and product status are available at: www.st.com. ECOPACK is an ST trademark.

3.1 TO-254AA package information

Figure 6. TO-254AA package outline

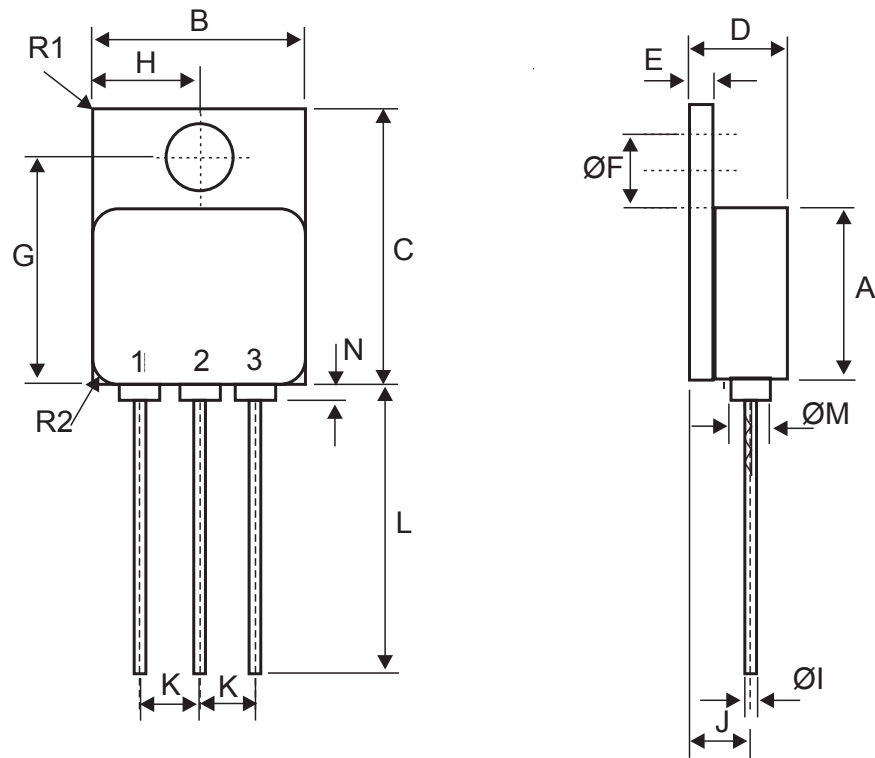

The TO-254-AA is a metallic package. It is not connected to any pin nor to the inside die.

Table 6. TO-254AA package mechanical data

Symbols	Dimensions (mm)			Dimensions (inches)		
	Min.	Typ.	Max.	Min.	Typ.	Max.
A	13.59		13.84	0.535		0.545
B	13.59		13.84	0.535		0.545
C	20.07		20.32	0.790		0.800
D	6.3		6.7	0.248		0.264
E	1		3.9	0.039		0.154
ØF	3.5		3.9	0.138		0.154
G	16.89		17.4	0.665		0.685
H	6.86 BSC			0.270 BSC		
ØI ⁽¹⁾	0.89		1.14	0.035		0.045
J	3.81 BSC			0.150 BSC		
K	3.81 BSC			0.150 BSC		
L	12.95		14.5	0.510		0.571
ØM		3.05			0.120	
N			0.71			0.028
R1 ⁽²⁾			1			0.039
R2 ⁽³⁾		1.65			0.065	

1. 3 locations
2. Radius of heatsink flange corner - 4 locations
3. Radius of body corner - 4 locations

4 Ordering information

Table 7. Ordering information

Order codes	ESCC detail specification	Quality level	Package	Lead finishing	Marking ⁽¹⁾	Weight	Packing
STPS40A150CHY1	-	engineering model	TO-254AA	Gold	STPS40A150CHY1	0.92 g	Strip pack
STPS40A150CHYG ⁽²⁾	5106/023/03	Flight model			510602303		
STPS40A150CHYT	5106/023/04			Soder dip	510602304		

1. *Specific marking only. The full marking includes in addition:*

- *For the Engineering Models: ST logo, date code, country of origin (FR)*
- *For flight parts: ST logo, date code, country of origin (FR), ESA logo, serial number of the part within the assembly lot*

2. *In development*

5 Other information

5.1 Traceability information

The date code information is structured as described in the table below.

Table 8. Date codes

Model	Date code ⁽¹⁾
EM	3yywwN
ESCC	yywwN

1. yy = year, ww = week number, N = lot index in the week.

5.2 Documentation

Each product shipment includes a set of associated documentation within the shipment box. This documentation depends on the quality level of the products, as detailed in the table below.

The documentation is provided on printed paper in a dedicated envelop.

Table 9. Default documentation provided with the parts

Quality level	Documentation
Engineering Model	Certificate of Conformance including : <ul style="list-style-type: none"> • Customer name • Customer purchase order number • ST sales order number and item • ST part number • Quantity delivered • Date code • Reference data sheet • Reference to TN1180 on engineering models • ST Rennes assembly lot ID
ESCC Flight	Certificate of Conformance including: <ul style="list-style-type: none"> • Customer name • Customer purchase order number • ST sales order number and item • ST part number • Quantity delivered • Date code • Serial numbers • Reference of the applicable ESCC Qualification maintenance lot • Reference to the ESCC detail specification • ST Rennes assembly lot ID

Revision history

Table 10. Document revision history

Date	Revision	Changes
24-Apr-2020	1	First issue.

IMPORTANT NOTICE – PLEASE READ CAREFULLY

STMicroelectronics NV and its subsidiaries (“ST”) reserve the right to make changes, corrections, enhancements, modifications, and improvements to ST products and/or to this document at any time without notice. Purchasers should obtain the latest relevant information on ST products before placing orders. ST products are sold pursuant to ST’s terms and conditions of sale in place at the time of order acknowledgement.

Purchasers are solely responsible for the choice, selection, and use of ST products and ST assumes no liability for application assistance or the design of Purchasers’ products.

No license, express or implied, to any intellectual property right is granted by ST herein.

Resale of ST products with provisions different from the information set forth herein shall void any warranty granted by ST for such product.

ST and the ST logo are trademarks of ST. For additional information about ST trademarks, please refer to www.st.com/trademarks. All other product or service names are the property of their respective owners.

Information in this document supersedes and replaces information previously supplied in any prior versions of this document.

© 2020 STMicroelectronics – All rights reserved