

## Small Signal Zener Diodes, Dual



20456

**DESIGN SUPPORT TOOLS**
[click logo to get started](#)
**3D**  
Models  
Available

PRIMARY CHARACTERISTICS		
PARAMETER	VALUE	UNIT
$V_Z$ range nom.	2.7 to 51	V
Test current $I_{ZT}$	5	mA
$V_Z$ specification	Pulse current	
Circuit configuration	Dual common anode	

**FEATURES**

- Dual silicon planar Zener diodes, common anode
- The Zener voltages are graded according to the international E24 standard. Standard Zener voltage tolerance is  $\pm 5\%$ , indicated by the "C" in the ordering code. Replace "C" with "B" for 2% tolerance.
- The parameters are valid for both diodes in one case.  $\Delta V_Z$  and  $\Delta R_{zj}$  of the two diodes in one case is  $\leq 5\%$
- AEC-Q101 qualified available
- ESD capability according to AEC-Q101:  
Human body model > 8 kV  
Machine model > 800 V
- Base P/N-E3 - RoHS-compliant, commercial grade
- Base P/N-HE3 - RoHS-compliant, AEC-Q101 qualified
- Material categorization: for definitions of compliance please see [www.vishay.com/doc?99912](http://www.vishay.com/doc?99912)

 AUTOMOTIVE  
GRADE  
Available

**RoHS**  
COMPLIANT

ORDERING INFORMATION			
DEVICE NAME	ORDERING CODE	TAPED UNITS PER REEL	MINIMUM ORDER QUANTITY
AZ23-series	AZ23C2V7-E3-08 to AZ23C51-E3-08	3000 (8 mm tape on 7" reel)	15 000
	AZ23B2V7-E3-08 to AZ23B51-E3-08		
	AZ23C2V7-HE3-08 to AZ23C51-HE3-08		
	AZ23B2V7-HE3-08 to AZ23B51-HE3-08		
	AZ23C2V7-E3-18 to AZ23C51-E3-18	10 000 (8 mm tape on 13" reel)	10 000
	AZ23B2V7-E3-18 to AZ23B51-E3-18		
	AZ23C2V7-HE3-18 to AZ23C51-HE3-18		
	AZ23B2V7-HE3-18 to AZ23B51-HE3-18		

PACKAGE				
PACKAGE NAME	WEIGHT	MOLDING COMPOUND FLAMMABILITY RATING	MOISTURE SENSITIVITY LEVEL	SOLDERING CONDITIONS
SOT-23	8.8 mg	UL 94 V-0	MSL level 1 (according J-STD-020)	260 °C/10 s at terminals

ABSOLUTE MAXIMUM RATINGS ( $T_{amb} = 25\text{ °C}$ , unless otherwise specified)				
PARAMETER	TEST CONDITION	SYMBOL	VALUE	UNIT
Power dissipation	Device on fiberglass substrate, see layout on page 6	$P_{tot}$	300	mW
Thermal resistance, junction to ambient air	Device on fiberglass substrate, see layout on page 6	$R_{thJA}$	420	K/W
Junction temperature		$T_j$	150	°C
Storage temperature range		$T_{stg}$	-65 to +150	°C
Operating temperature range		$T_{op}$	-55 to +150	°C



<b>ELECTRICAL CHARACTERISTICS</b> ( $T_{amb} = 25\text{ }^{\circ}\text{C}$ , unless otherwise specified)												
PART NUMBER	MARKING CODE	ZENER VOLTAGE RANGE <sup>(1)</sup>			TEST CURRENT		REVERSE VOLTAGE		DYNAMIC RESISTANCE		TEMPERATURE COEFFICIENT OF ZENER VOLTAGE	
		$V_Z$ at $I_{ZT1}$			$I_{ZT1}$	$I_{ZT2}$	$V_R$ at $I_R$		$Z_Z$ at $I_{ZT1}$	$Z_{ZK}$ at $I_{ZT2}$	$\alpha_{VZ}$ at $I_{ZT}$	
		V			mA		V	nA	$\Omega$		$10^{-4}/^{\circ}\text{C}$	
		MIN.	NOM.	MAX.							MIN.	MAX.
AZ23C2V7	D1	2.5	2.7	2.9	5	1	-	-	75 (< 83)	< 500	-9	-4
AZ23C3V0	D2	2.8	3.0	3.2	5	1	-	-	80 (< 95)	< 500	-9	-3
AZ23C3V3	D3	3.1	3.3	3.5	5	1	-	-	80 (< 95)	< 500	-8	-3
AZ23C3V6	D4	3.4	3.6	3.8	5	1	-	-	80 (< 95)	< 500	-8	-3
AZ23C3V9	D5	3.7	3.9	4.1	5	1	-	-	80 (< 95)	< 500	-7	-3
AZ23C4V3	D6	4	4.3	4.6	5	1	-	-	80 (< 95)	< 500	-6	-1
AZ23C4V7	D7	4.4	4.7	5	5	1	-	-	70 (< 78)	< 500	-5	2
AZ23C5V1	D8	4.8	5.1	5.4	5	1	> 0.8	100	30 (< 60)	< 480	-3	4
AZ23C5V6	D9	5.2	5.6	6	5	1	> 1	100	10 (< 40)	< 400	-2	6
AZ23C6V2	D10	5.8	6.2	6.6	5	1	> 2	100	4.8 (< 10)	< 200	-1	7
AZ23C6V8	D11	6.4	6.8	7.2	5	1	> 3	100	4.5 (< 8)	< 150	2	7
AZ23C7V5	D12	7	7.5	7.9	5	1	> 5	100	4 (< 7)	< 50	3	7
AZ23C8V2	D13	7.7	8.2	8.7	5	1	> 6	100	4.5 (< 7)	< 50	4	7
AZ23C9V1	D14	8.5	9.1	9.6	5	1	> 7	100	4.8 (< 10)	< 50	5	8
AZ23C10	D15	9.4	10	10.6	5	1	> 7.5	100	5.2 (< 15)	< 70	5	8
AZ23C11	D16	10.4	11	11.6	5	1	> 8.5	100	6 (< 20)	< 70	5	9
AZ23C12	D17	11.4	12	12.7	5	1	> 9	100	7 (< 20)	< 90	6	9
AZ23C13	D18	12.4	13	14.1	5	1	> 10	100	9 (< 25)	< 110	7	9
AZ23C15	D19	13.8	15	15.6	5	1	> 11	100	11 (< 30)	< 110	7	9
AZ23C16	D20	15.3	16	17.1	5	1	> 12	100	13 (< 40)	< 170	8	9.5
AZ23C18	D21	16.8	18	19.1	5	1	> 14	100	18 (< 50)	< 170	8	9.5
AZ23C20	D22	18.8	20	21.2	5	1	> 15	100	20 (< 50)	< 220	8	10
AZ23C22	D23	20.8	22	23.3	5	1	> 17	100	25 (< 55)	< 220	8	10
AZ23C24	D24	22.8	24	25.6	5	1	> 18	100	28 (< 80)	< 220	8	10
AZ23C27	D25	25.1	27	28.9	5	1	> 20	100	30 (< 80)	< 250	8	10
AZ23C30	D26	28	30	32	5	1	> 22.5	100	35 (< 80)	< 250	8	10
AZ23C33	D27	31	33	35	5	1	> 25	100	40 (< 80)	< 250	8	10
AZ23C36	D28	34	36	38	5	1	> 27	100	40 (< 90)	< 250	8	10
AZ23C39	D29	37	39	41	5	1	> 29	100	50 (< 90)	< 300	10	12
AZ23C43	D30	40	43	46	5	1	> 32	100	60 (< 100)	< 700	10	12
AZ23C47	D31	44	47	50	5	1	> 35	100	70 (< 100)	< 750	10	12
AZ23C51	D32	48	51	54	5	1	> 38	100	70 (< 100)	< 750	10	12

**Note**

<sup>(1)</sup> Tested with pulses  $t_p = 5\text{ ms}$



<b>ELECTRICAL CHARACTERISTICS</b> ( $T_{amb} = 25\text{ }^{\circ}\text{C}$ , unless otherwise specified)												
PART NUMBER	MARKING CODE	ZENER VOLTAGE RANGE <sup>(1)</sup>			TEST CURRENT		REVERSE VOLTAGE		DYNAMIC RESISTANCE		TEMPERATURE COEFFICIENT OF ZENER VOLTAGE	
		$V_Z$ at $I_{ZT1}$			$I_{ZT1}$	$I_{ZT2}$	$V_R$ at $I_R$		$Z_Z$ at $I_{ZT1}$	$Z_{ZK}$ at $I_{ZT2}$	$\alpha_{VZ}$ at $I_{ZT}$	
		V			mA		V	nA	$\Omega$		$10^{-4}/^{\circ}\text{C}$	
		MIN.	NOM.	MAX.							MIN.	MAX.
AZ23B2V7	D1	2.65	2.7	2.75	5	1	-	-	75 (< 83)	< 500	-9	-4
AZ23B3V0	D2	2.94	3.0	3.06	5	1	-	-	80 (< 95)	< 500	-9	-3
AZ23B3V3	D3	3.23	3.3	3.37	5	1	-	-	80 (< 95)	< 500	-8	-3
AZ23B3V6	D4	3.53	3.6	3.67	5	1	-	-	80 (< 95)	< 500	-8	-3
AZ23B3V9	D5	3.82	3.9	3.98	5	1	-	-	80 (< 95)	< 500	-7	-3
AZ23B4V3	D6	4.21	4.3	4.39	5	1	-	-	80 (< 95)	< 500	-6	-1
AZ23B4V7	D7	4.61	4.7	4.79	5	1	-	-	70 (< 78)	< 500	-5	2
AZ23B5V1	D8	5	5.1	5.2	5	1	> 0.8	100	30 (< 60)	< 480	-3	4
AZ23B5V6	D9	5.49	5.6	5.71	5	1	> 1	100	10 (< 40)	< 400	-2	6
AZ23B6V2	D10	6.08	6.2	6.32	5	1	> 2	100	4.8 (< 10)	< 200	-1	7
AZ23B6V8	D11	6.66	6.8	6.94	5	1	> 3	100	4.5 (< 8)	< 150	2	7
AZ23B7V5	D12	7.35	7.5	7.65	5	1	> 5	100	4 (< 7)	< 50	3	7
AZ23B8V2	D13	8.04	8.2	8.36	5	1	> 6	100	4.5 (< 7)	< 50	4	7
AZ23B9V1	D14	8.92	9.1	9.28	5	1	> 7	100	4.8 (< 10)	< 50	5	8
AZ23B10	D15	9.8	10	10.2	5	1	> 7.5	100	5.2 (< 15)	< 70	5	8
AZ23B11	D16	10.8	11	11.2	5	1	> 8.5	100	6 (< 20)	< 70	5	9
AZ23B12	D17	11.8	12	12.2	5	1	> 9	100	7 (< 20)	< 90	6	9
AZ23B13	D18	12.7	13	13.3	5	1	> 10	100	9 (< 25)	< 110	7	9
AZ23B15	D19	14.7	15	15.3	5	1	> 11	100	11 (< 30)	< 110	7	9
AZ23B16	D20	15.7	16	16.3	5	1	> 12	100	13 (< 40)	< 170	8	9.5
AZ23B18	D21	17.6	18	18.4	5	1	> 14	100	18 (< 50)	< 170	8	9.5
AZ23B20	D22	19.6	20	20.4	5	1	> 15	100	20 (< 50)	< 220	8	10
AZ23B22	D23	21.6	22	22.4	5	1	> 17	100	25 (< 55)	< 220	8	10
AZ23B24	D24	23.5	24	24.5	5	1	> 18	100	28 (< 80)	< 220	8	10
AZ23B27	D25	26.5	27	27.5	5	1	> 20	100	30 (< 80)	< 250	8	10
AZ23B30	D26	29.4	30	30.6	5	1	> 22.5	100	35 (< 80)	< 250	8	10
AZ23B33	D27	32.3	33	33.7	5	1	> 25	100	40 (< 80)	< 250	8	10
AZ23B36	D28	35.3	36	36.7	5	1	> 27	100	40 (< 90)	< 250	8	10
AZ23B39	D29	38.2	39	39.8	5	1	> 29	100	50 (< 90)	< 300	10	12
AZ23B43	D30	42.1	43	43.9	5	1	> 32	100	60 (< 100)	< 700	10	12
AZ23B47	D31	46.1	47	47.9	5	1	> 35	100	70 (< 100)	< 750	10	12
AZ23B51	D32	50	51	52	5	1	> 38	100	70 (< 100)	< 750	10	12

**Note**

<sup>(1)</sup> Tested with pulses  $t_p = 5\text{ ms}$

**TYPICAL CHARACTERISTICS** ( $T_{amb} = 25\text{ }^{\circ}\text{C}$ , unless otherwise specified)

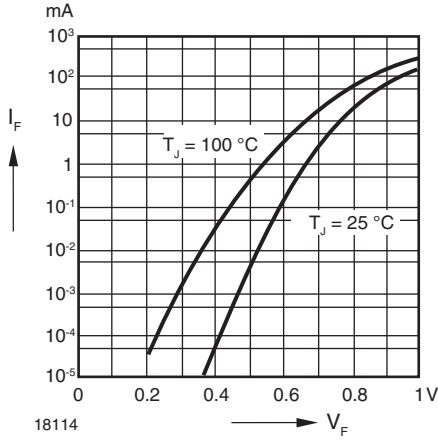

Fig. 1 - Forward Characteristics

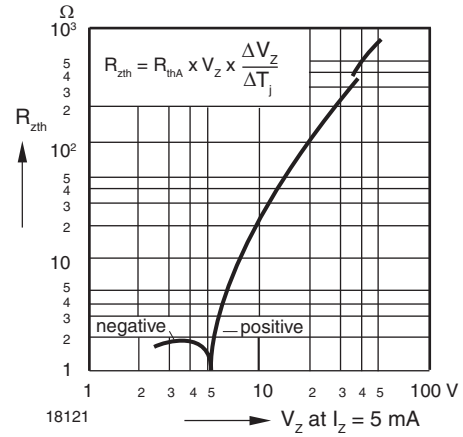

Fig. 4 - Thermal Differential Resistance vs. Zener Voltage

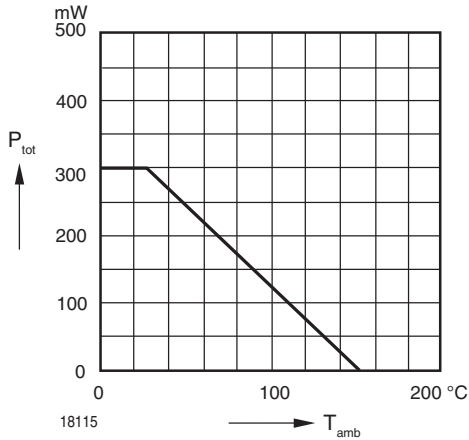

Fig. 2 - Admissible Power Dissipation vs. Ambient Temperature

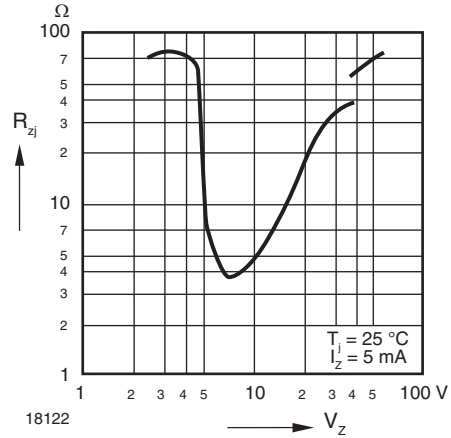

Fig. 5 - Dynamic Resistance vs. Zener Voltage

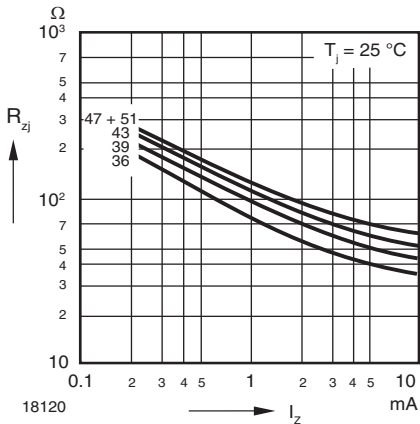

Fig. 3 - Dynamic Resistance vs. Zener Current

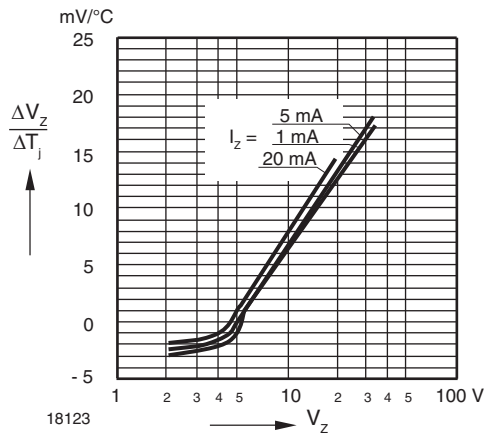

Fig. 6 - Temperature Dependence of Zener Voltage vs. Zener Voltage



Fig. 7 - Change of Zener Voltage vs. Junction Temperature



Fig. 10 - Change of Zener Voltage from Turn-on up to the Point of Thermal Equilibrium vs. Zener Voltage

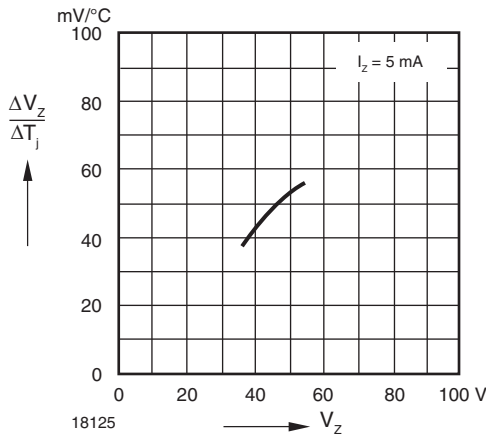

Fig. 8 - Temperature Dependence of Zener Voltage vs. Zener Voltage



Fig. 11 - Change of Zener Voltage from Turn-on up to the Point of Thermal Equilibrium vs. Zener Voltage

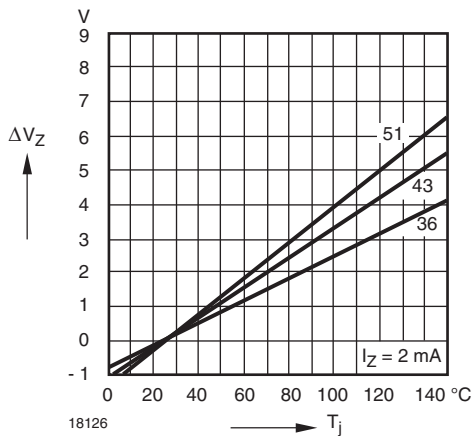

Fig. 9 - Change of Zener Voltage vs. Junction Temperature

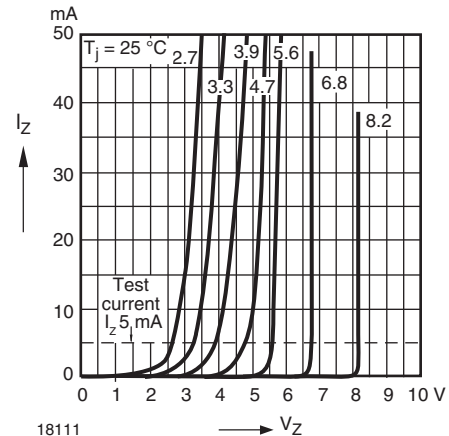

Fig. 12 - Breakdown Characteristics



Fig. 13 - Breakdown Characteristics

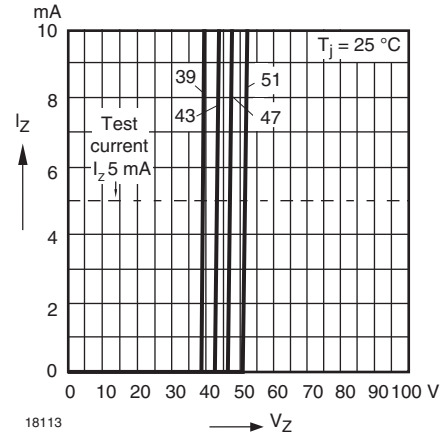
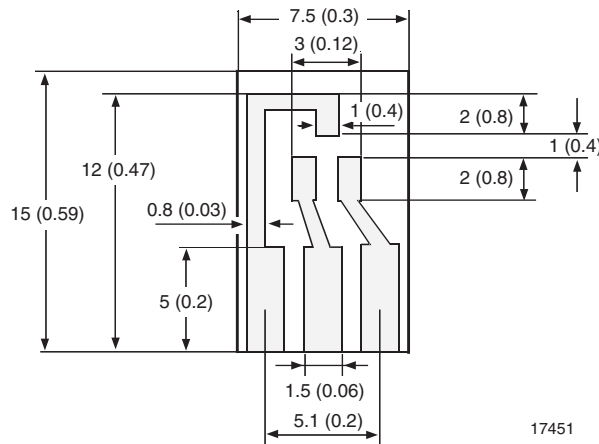

Fig. 14 - Breakdown Characteristics

**LAYOUT FOR R<sub>thJA</sub> TEST**

Thickness: fiberglass 0.059" (1.5 mm)

Copper leads 0.012" (0.3 mm)





PACKAGE DIMENSIONS in millimeters (inches): SOT-23

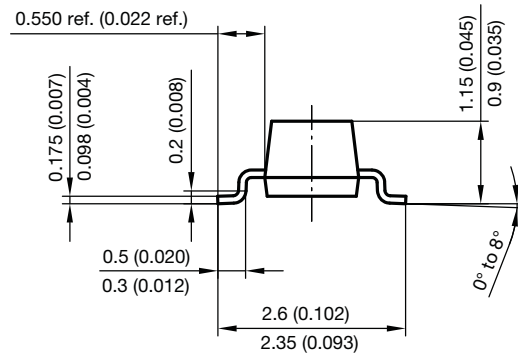
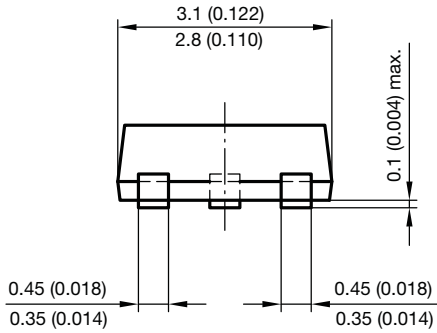

Foot print recommendation:

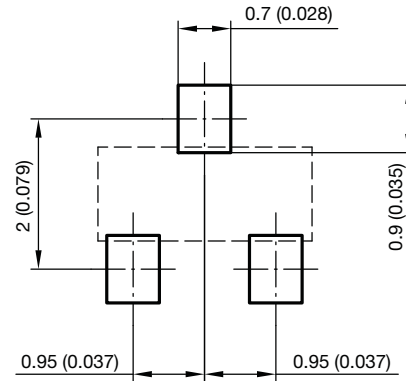

Document no.: 6.541-5014.01-4  
Rev. 8 - Date: 23.Sept.2009  
17418



## **Disclaimer**

ALL PRODUCT, PRODUCT SPECIFICATIONS AND DATA ARE SUBJECT TO CHANGE WITHOUT NOTICE TO IMPROVE RELIABILITY, FUNCTION OR DESIGN OR OTHERWISE.

Vishay Intertechnology, Inc., its affiliates, agents, and employees, and all persons acting on its or their behalf (collectively, "Vishay"), disclaim any and all liability for any errors, inaccuracies or incompleteness contained in any datasheet or in any other disclosure relating to any product.

Vishay makes no warranty, representation or guarantee regarding the suitability of the products for any particular purpose or the continuing production of any product. To the maximum extent permitted by applicable law, Vishay disclaims (i) any and all liability arising out of the application or use of any product, (ii) any and all liability, including without limitation special, consequential or incidental damages, and (iii) any and all implied warranties, including warranties of fitness for particular purpose, non-infringement and merchantability.

Statements regarding the suitability of products for certain types of applications are based on Vishay's knowledge of typical requirements that are often placed on Vishay products in generic applications. Such statements are not binding statements about the suitability of products for a particular application. It is the customer's responsibility to validate that a particular product with the properties described in the product specification is suitable for use in a particular application. Parameters provided in datasheets and / or specifications may vary in different applications and performance may vary over time. All operating parameters, including typical parameters, must be validated for each customer application by the customer's technical experts. Product specifications do not expand or otherwise modify Vishay's terms and conditions of purchase, including but not limited to the warranty expressed therein.

Hyperlinks included in this datasheet may direct users to third-party websites. These links are provided as a convenience and for informational purposes only. Inclusion of these hyperlinks does not constitute an endorsement or an approval by Vishay of any of the products, services or opinions of the corporation, organization or individual associated with the third-party website. Vishay disclaims any and all liability and bears no responsibility for the accuracy, legality or content of the third-party website or for that of subsequent links.

Except as expressly indicated in writing, Vishay products are not designed for use in medical, life-saving, or life-sustaining applications or for any other application in which the failure of the Vishay product could result in personal injury or death. Customers using or selling Vishay products not expressly indicated for use in such applications do so at their own risk. Please contact authorized Vishay personnel to obtain written terms and conditions regarding products designed for such applications.

No license, express or implied, by estoppel or otherwise, to any intellectual property rights is granted by this document or by any conduct of Vishay. Product names and markings noted herein may be trademarks of their respective owners.