

Turbo 2 ultrafast high voltage rectifier

Datasheet - production data

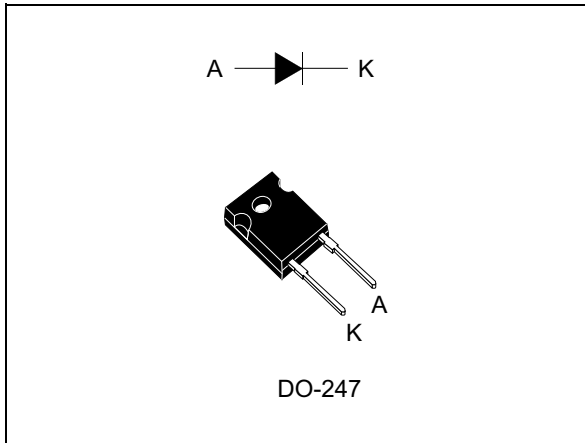

Features

- Ultrafast switching
- Low reverse current
- Low thermal resistance
- Reduces switching and conduction losses

Description

The STTH30ACS06W, which is ST Turbo 2 600 V technology, is suited as boost diode especially in air conditioning equipment for continuous mode interleaved power factor correction.

The device is also intended for use as a freewheeling diode in power supplies and other power switching applications.

Table 1. Device summary

Symbol	Value
$I_{F(AV)}$	30 A
V_{RRM}	600 V
T_j (max)	175 °C
V_F (typ)	1.45 V
t_{rr} (max)	30 ns

1 Characteristics

Table 2. Absolute ratings (limiting values at $T_j = 25\text{ °C}$, unless otherwise specified)

Symbol	Parameter	Value	Unit	
V_{RRM}	Repetitive peak reverse voltage	600	V	
$I_{F(RMS)}$	RMS forward current	50	A	
$I_{F(AV)}$	Average forward current	30	A	
I_{FSM}	Surge non repetitive forward current	$t_p = 10\text{ ms}$ sinusoidal	190	A
T_{stg}	Storage temperature range	-65 to +175	°C	
T_j	Maximum operating junction temperature	+175	°C	

Table 3. Thermal parameters

Symbol	Parameter	Value	Unit
$R_{th(j-c)}$	Junction to case	1.2	°C/W

Table 4. Static electrical characteristics

Symbol	Parameter	Test conditions	Min.	Typ.	Max.	Unit
$I_R^{(1)}$	Reverse leakage current	$T_j = 25\text{ °C}$	-		5	μA
		$T_j = 150\text{ °C}$	-	30	300	
$V_F^{(2)}$	Forward voltage drop	$T_j = 25\text{ °C}$	-		2.4	V
		$T_j = 150\text{ °C}$	-	1.45	1.9	

1. Pulse test: $t_p = 5\text{ ms}$, $\delta < 2\%$
2. Pulse test: $t_p = 380\text{ }\mu\text{s}$, $\delta < 2\%$

To evaluate the conduction losses use the following equation:

$$P = 1.42 \times I_{F(AV)} + 0.016 \times I_{F(RMS)}^2$$

Table 5. Dynamic electrical characteristics

Symbol	Parameter	Test conditions	Min.	Typ.	Max.	Unit
t_{rr}	Reverse recovery time	$T_j = 25\text{ °C}$			30	ns
			$I_F = 0.5\text{ A}$, $I_{rr} = 0.25\text{ A}$, $I_R = 1\text{ A}$		40	55
I_{RM}	Reverse recovery current	$T_j = 125\text{ °C}$		7.8	10.5	A
t_{fr}	Forward recovery time	$T_j = 25\text{ °C}$			300	ns
V_{FP}	Forward recovery voltage		$I_F = 30\text{ A}$, $dI_F/dt = 200\text{ A}/\mu\text{s}$, $V_{FR} = 2.8\text{ V}$		3.5	V

Figure 1. Average forward power dissipation versus average forward current

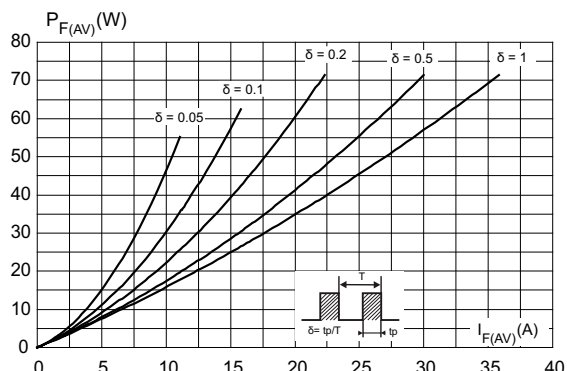

Figure 2. Forward voltage drop versus forward current (typical values)

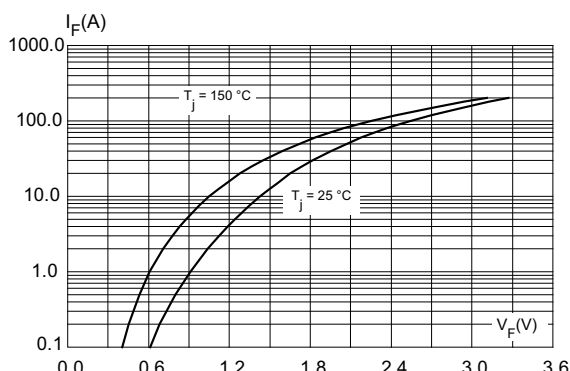

Figure 3. Forward voltage drop versus forward current (maximum values)

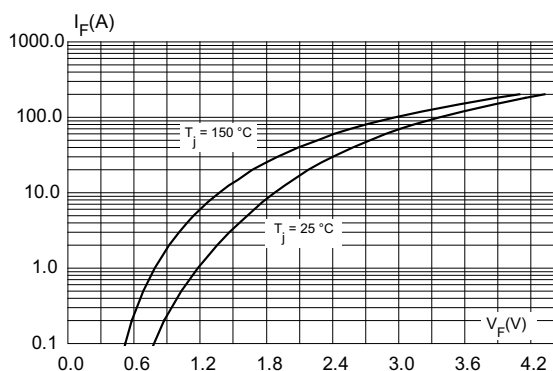

Figure 4. Relative variation of thermal impedance junction to case versus pulse duration

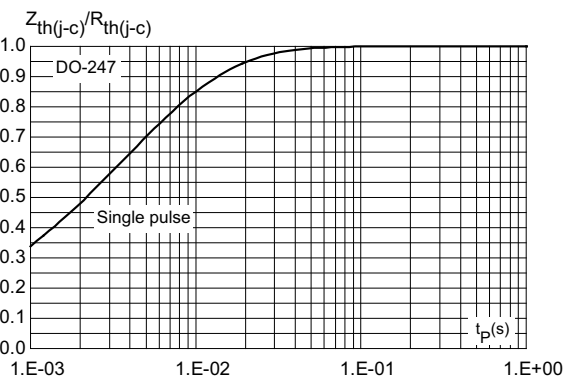

Figure 5. Peak reverse recovery current versus di_F/dt (typical values)

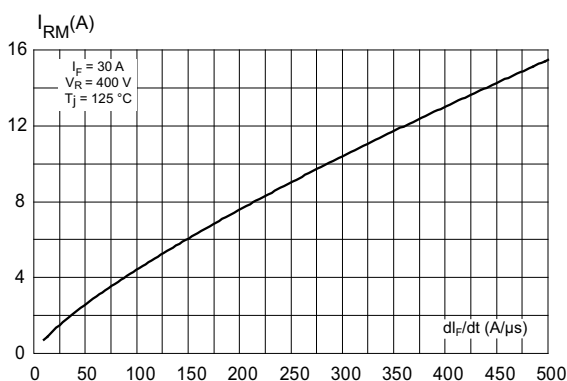

Figure 6. Reverse recovery time versus di_F/dt (typical values)

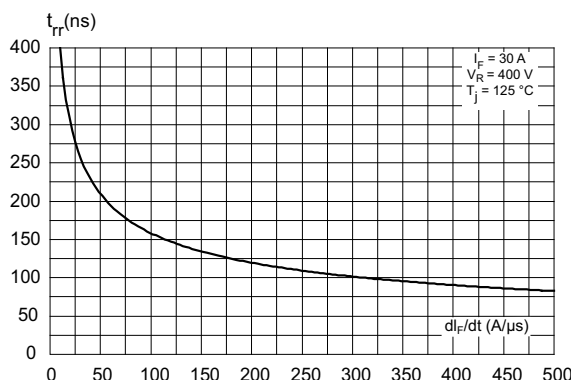

Figure 7. Reverse recovery charges versus di_F/dt (typical values)

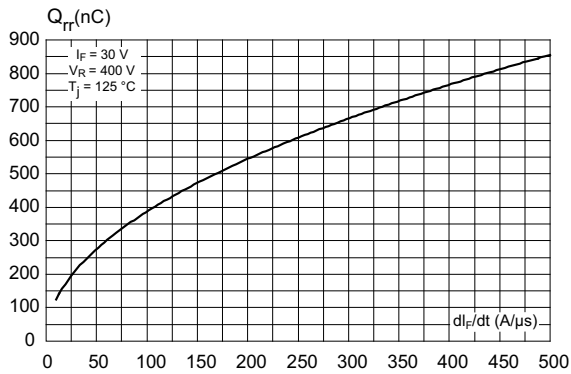

Figure 8. Softness factor versus di_F/dt (typical values)

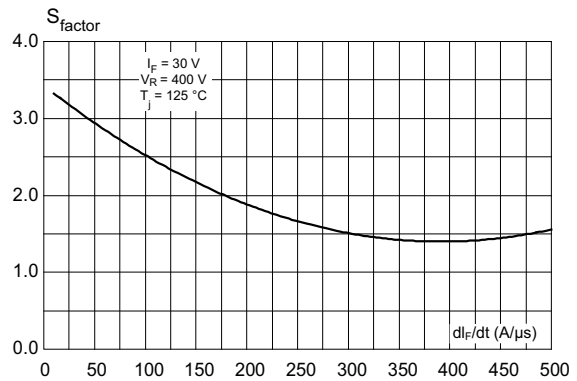

Figure 9. Relative variations of dynamic parameters versus junction temperature

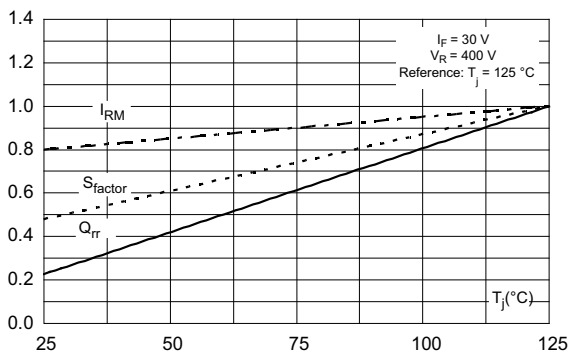

Figure 10. Transient peak forward voltage versus di_F/dt (typical values)

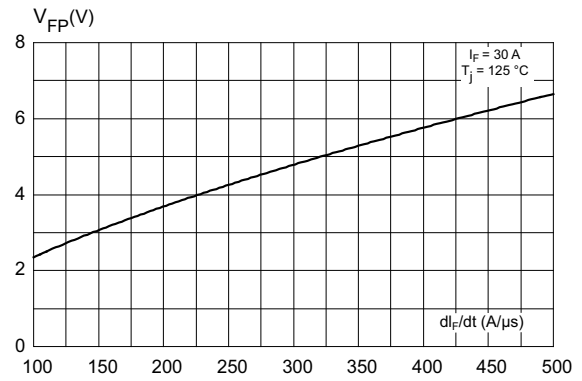

Figure 11. Forward recovery time versus di_F/dt (typical values)

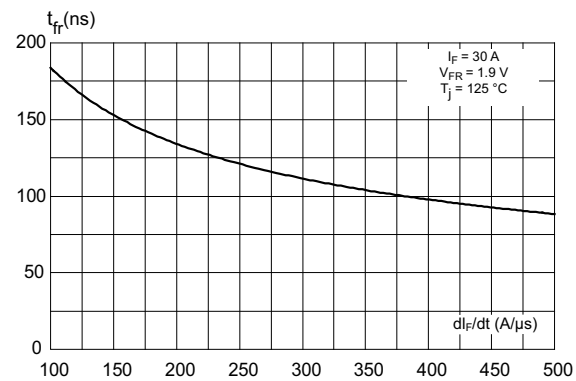
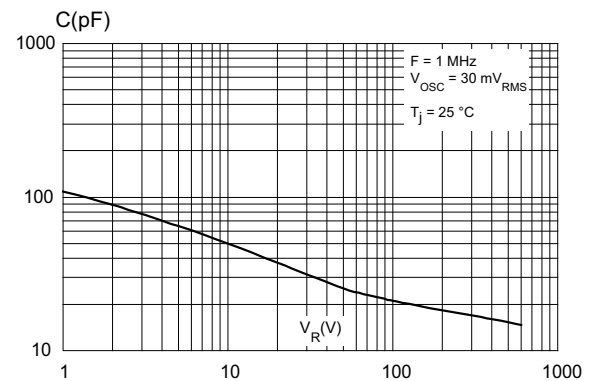

Figure 12. Junction capacitance versus reverse voltage applied (typical values)



2 Package information

- Epoxy meets UL94, V0
- Cooling method by conduction (C)
- Recommended torque value: 0.8 N·m
- Maximum torque value: 1.0 N·m

In order to meet environmental requirements, ST offers these devices in different grades of ECOPACK® packages, depending on their level of environmental compliance. ECOPACK® specifications, grade definitions and product status are available at: www.st.com. ECOPACK® is an ST trademark.

2.1 DO-247 package information

Figure 13. DO-247 package outline

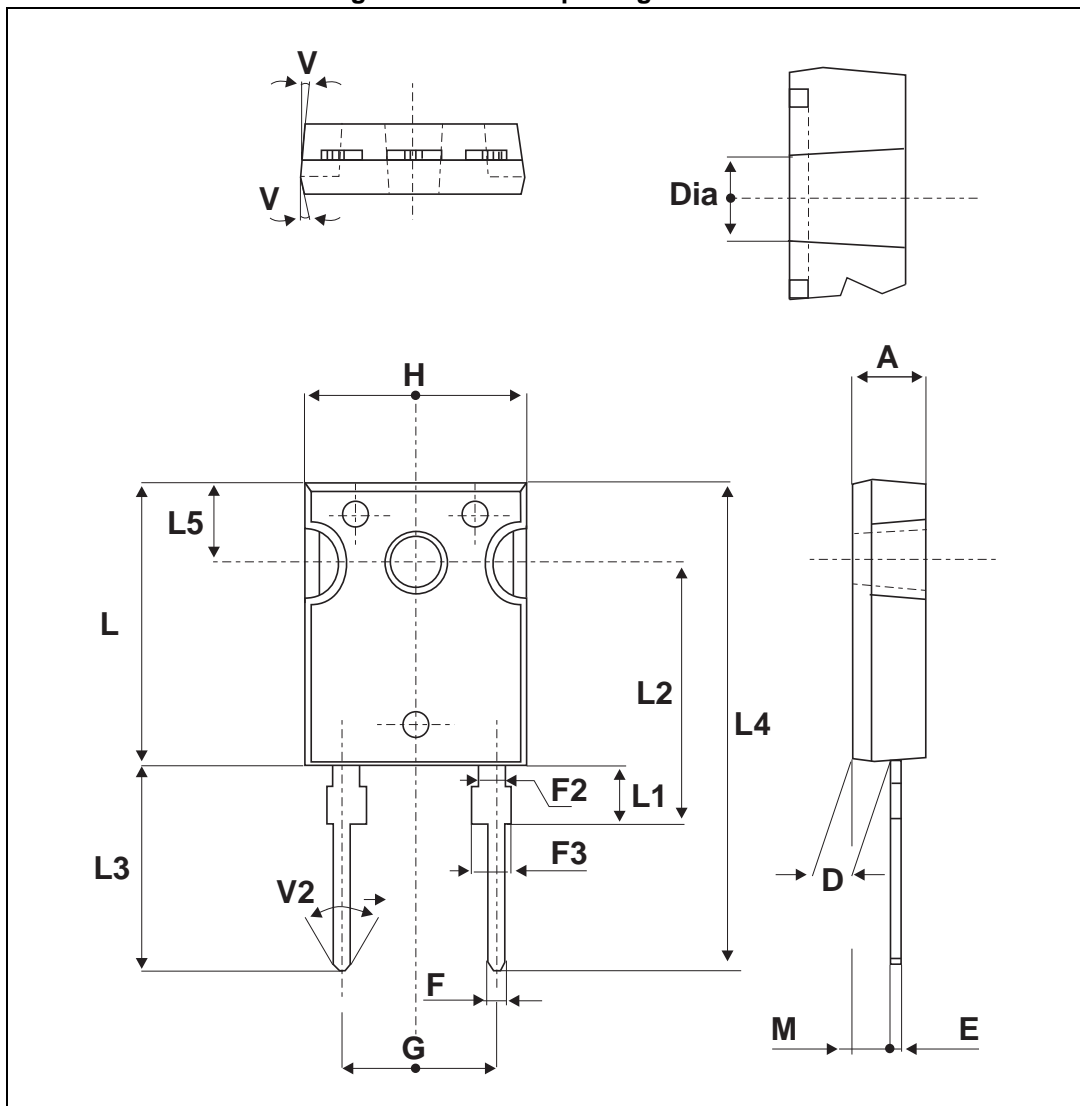

Table 6. DO-247 package mechanical data

Ref.	Dimensions					
	Millimeters			Inches		
	Min.	Typ.	Max.	Min.	Typ.	Max.
A	4.85		5.15	0.191		0.203
D	2.20		2.60	0.086		0.102
E	0.40		0.80	0.015		0.031
F	1.00		1.40	0.039		0.055
F2		2.00			0.078	
F3	2.00		2.40	0.078		0.094
G		10.90			0.429	
H	15.45		15.75	0.608		0.620
L	19.85		20.15	0.781		0.793
L1	3.70		4.30	0.145		0.169
L2		18.50			0.728	
L3	14.20		14.80	0.559		0.582
L4		34.60			1.362	
L5		5.50			0.216	
M	2.00		3.00	0.078		0.118
V		5°			5°	
V2		60°			60°	
Dia.	3.55		3.65	0.139		0.143

3 Ordering information

Table 7. Ordering information

Order code	Marking	Package	Weight	Base qty	Delivery mode
STTH30ACS06W	STTH30ACS06W	DO-247	1.8 g	50	Tube

4 Revision history

Table 8. Document revision history

Date	Revision	Changes
22-Sep-2015	1	First issue.

IMPORTANT NOTICE – PLEASE READ CAREFULLY

STMicroelectronics NV and its subsidiaries (“ST”) reserve the right to make changes, corrections, enhancements, modifications, and improvements to ST products and/or to this document at any time without notice. Purchasers should obtain the latest relevant information on ST products before placing orders. ST products are sold pursuant to ST’s terms and conditions of sale in place at the time of order acknowledgement.

Purchasers are solely responsible for the choice, selection, and use of ST products and ST assumes no liability for application assistance or the design of Purchasers’ products.

No license, express or implied, to any intellectual property right is granted by ST herein.

Resale of ST products with provisions different from the information set forth herein shall void any warranty granted by ST for such product.

ST and the ST logo are trademarks of ST. All other product or service names are the property of their respective owners.

Information in this document supersedes and replaces information previously supplied in any prior versions of this document.

© 2015 STMicroelectronics – All rights reserved