

# NTZD3158P

## Small Signal MOSFET

-20 V, -430 mA, Dual P-Channel with ESD Protection, SOT-563

### Features

- Low  $R_{DS(on)}$  Improving System Efficiency
- Low Threshold Voltage
- ESD Protected Gate
- Small Footprint 1.6 x 1.6 mm
- These Devices are Pb-Free, Halogen Free/BFR Free and are RoHS Compliant

### Applications

- Load/Power Switches
- Power Supply Converter Circuits
- Battery Management
- Cell Phones, Digital Cameras, PDAs, Pagers, etc.

### MAXIMUM RATINGS ( $T_J = 25^\circ\text{C}$ unless otherwise noted.)

Parameter		Symbol	Value	Unit	
Drain-to-Source Voltage		$V_{DSS}$	-20	V	
Gate-to-Source Voltage		$V_{GS}$	$\pm 6.0$	V	
Continuous Drain Current (Note 1)	Steady State	$I_D$	$T_A = 25^\circ\text{C}$	-430	mA
			$T_A = 85^\circ\text{C}$	-310	
Power Dissipation (Note 1)	Steady State	$P_D$	250	mW	
Continuous Drain Current (Note 1)	$t \leq 5\text{ s}$	$I_D$	$T_A = 25^\circ\text{C}$	-455	mA
			$T_A = 85^\circ\text{C}$	-328	
Power Dissipation (Note 1)	$t \leq 5\text{ s}$	$P_D$	280	mW	
Pulsed Drain Current	$t_p = 10\ \mu\text{s}$	$I_{DM}$	-750	mA	
Operating Junction and Storage Temperature		$T_J, T_{STG}$	-55 to 150	$^\circ\text{C}$	
Source Current (Body Diode)		$I_S$	-350	mA	
Lead Temperature for Soldering Purposes (1/8" from case for 10 s)		$T_L$	260	$^\circ\text{C}$	

### THERMAL RESISTANCE RATINGS

Parameter	Symbol	Max	Unit
Junction-to-Ambient - Steady State (Note 1)	$R_{\theta JA}$	500	$^\circ\text{C}/\text{W}$
Junction-to-Ambient - $t \leq 5\text{ s}$ (Note 1)		447	

Stresses exceeding Maximum Ratings may damage the device. Maximum Ratings are stress ratings only. Functional operation above the Recommended Operating Conditions is not implied. Extended exposure to stresses above the Recommended Operating Conditions may affect device reliability.

1. Surface mounted on FR4 board using 1 in. sq. pad size (Cu. area = 1.127 in. sq. [1 oz.] including traces).



ON Semiconductor®

<http://onsemi.com>

$V_{(BR)DSS}$	$R_{DS(on)}$ Typ	$I_D$ Max
-20 V	0.5 $\Omega$ @ -4.5 V	-430 mA
	0.6 $\Omega$ @ -2.5 V	
	1.0 $\Omega$ @ -1.8 V	

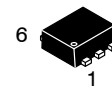
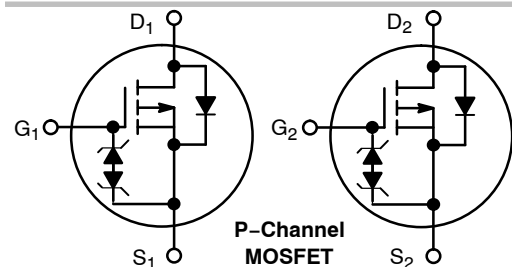

SOT-563-6  
CASE 463A

### MARKING DIAGRAM

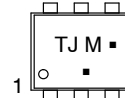

$T_J$  = Specific Device Code  
 $M$  = Date Code  
 ■ = Pb-Free Package  
 (Note: Microdot may be in either location)

### PINOUT: SOT-563

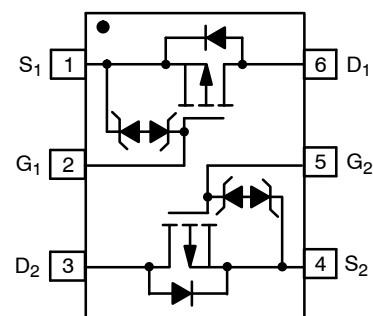

Top View

### ORDERING INFORMATION

Device	Package	Shipping†
NTZD3158PT1G	SOT-563 (Pb-Free)	4000 / Tape & Reel

†For information on tape and reel specifications, including part orientation and tape sizes, please refer to our Tape and Reel Packaging Specifications Brochure, BRD8011/D.

# NTZD3158P

## ELECTRICAL CHARACTERISTICS (T<sub>J</sub> = 25°C unless otherwise noted.)

Parameter	Symbol	Test Condition	Min	Typ	Max	Unit
<b>OFF CHARACTERISTICS</b>						
Drain-to-Source Breakdown Voltage	V <sub>(BR)DSS</sub>	V <sub>GS</sub> = 0 V, I <sub>D</sub> = -250 μA	-20			V
Drain-to-Source Breakdown Voltage Temperature Coefficient	V <sub>(BR)DSS</sub> /T <sub>J</sub>			18		mV/°C
Zero Gate Voltage Drain Current	I <sub>DSS</sub>	V <sub>GS</sub> = 0 V, T <sub>J</sub> = 25°C			-1.0	μA
		V <sub>DS</sub> = -16 V, T <sub>J</sub> = 125°C			-2.0	
Gate-to-Source Leakage Current	I <sub>GSS</sub>	V <sub>DS</sub> = 0 V, V <sub>GS</sub> = ±4.5 V			±2.0	μA

## ON CHARACTERISTICS (Note 2)

Gate Threshold Voltage	V <sub>GS(TH)</sub>	V <sub>GS</sub> = V <sub>DS</sub> , I <sub>D</sub> = -250 μA	-0.45		-1.0	V
Negative Threshold Temperature Coefficient	V <sub>GS(TH)</sub> /T <sub>J</sub>			-1.9		mV/°C
Drain-to-Source On Resistance	R <sub>DS(on)</sub>	V <sub>GS</sub> = -4.5 V, I <sub>D</sub> = -430 mA		0.5	0.9	Ω
		V <sub>GS</sub> = -2.5 V, I <sub>D</sub> = -300 mA		0.6	1.2	
		V <sub>GS</sub> = -1.8 V, I <sub>D</sub> = -150 mA		1.0	2.0	
Forward Transconductance	g <sub>FS</sub>	V <sub>DS</sub> = -10 V, I <sub>D</sub> = -430 mA		1.0		S

## CHARGES AND CAPACITANCES

Input Capacitance	C <sub>ISS</sub>	V <sub>GS</sub> = 0 V, f = 1.0 MHz, V <sub>DS</sub> = -16 V		105	175	pF
Output Capacitance	C <sub>OSS</sub>			15	30	
Reverse Transfer Capacitance	C <sub>RSS</sub>			10	20	
Total Gate Charge	Q <sub>G(TOT)</sub>	V <sub>GS</sub> = -4.5 V, V <sub>DS</sub> = -10 V, I <sub>D</sub> = -215 mA		1.7	2.5	nC
Threshold Gate Charge	Q <sub>G(TH)</sub>			0.1		
Gate-to-Source Charge	Q <sub>GS</sub>			0.3		
Gate-to-Drain Charge	Q <sub>GD</sub>			0.4		

## SWITCHING CHARACTERISTICS (Note 3)

Turn-On Delay Time	t <sub>d(on)</sub>	V <sub>GS</sub> = -4.5 V, V <sub>DD</sub> = -10 V, I <sub>D</sub> = -215 mA, R <sub>G</sub> = 10 Ω		10		ns
Rise Time	t <sub>r</sub>			12		
Turn-Off Delay Time	t <sub>d(off)</sub>			35		
Fall Time	t <sub>f</sub>			19		

## DRAIN-SOURCE DIODE CHARACTERISTICS

Forward Diode Voltage	V <sub>SD</sub>	V <sub>GS</sub> = 0 V, I <sub>S</sub> = -350 mA	T <sub>J</sub> = 25°C		-0.8	-1.2	V
Reverse Recovery Time	t <sub>RR</sub>	V <sub>GS</sub> = 0 V, dI <sub>SD</sub> /dt = 100 A/μs, I <sub>S</sub> = -350 mA			13		ns

- Pulse Test: pulse width ≤ 300 μs, duty cycle ≤ 2%.
- Switching characteristics are independent of operating junction temperatures.

# NTZD3158P

## TYPICAL PERFORMANCE CURVES ( $T_J = 25^\circ\text{C}$ unless otherwise noted)

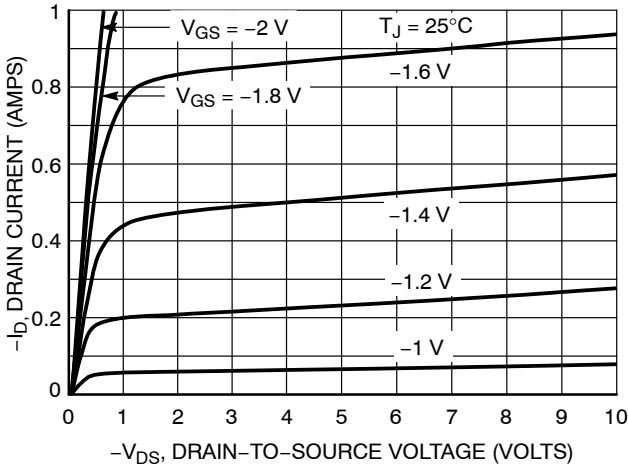

Figure 1. On-Region Characteristics

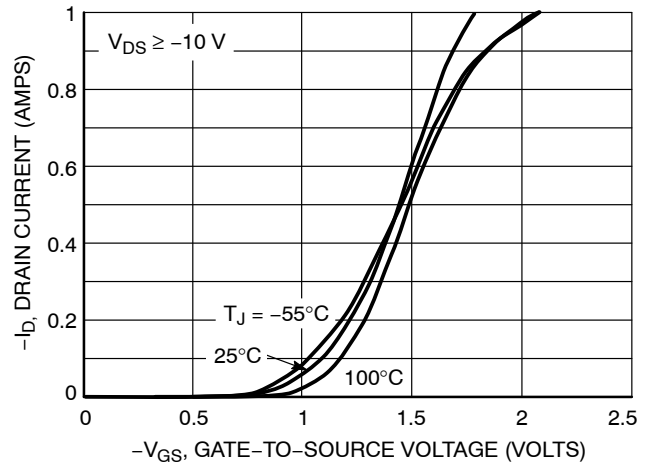

Figure 2. Transfer Characteristics

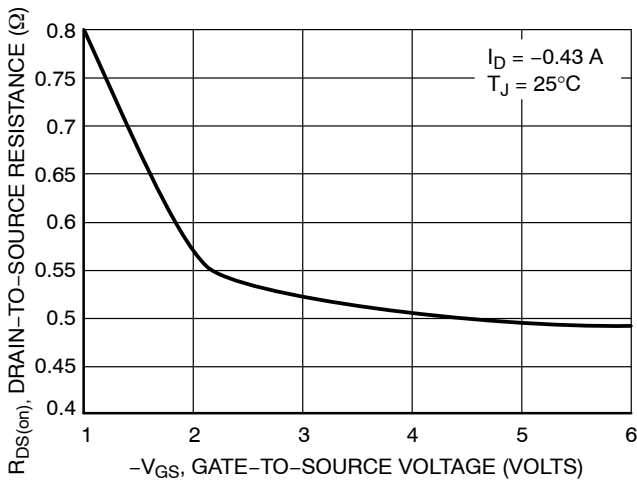

Figure 3. On-Resistance vs. Gate-to-Source Voltage

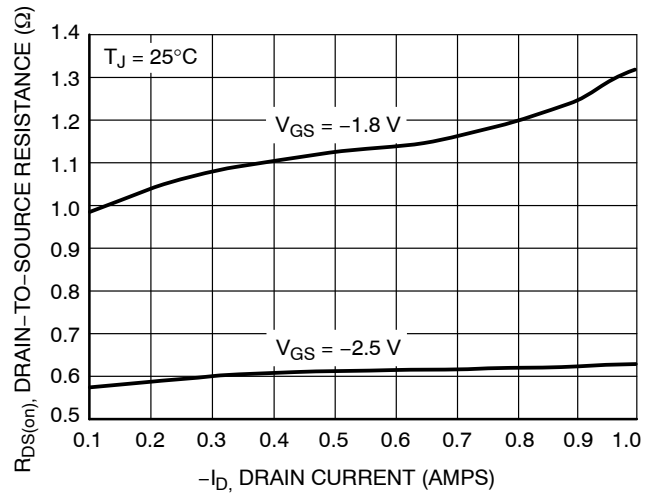

Figure 4. On-Resistance vs. Drain Current and Gate Voltage

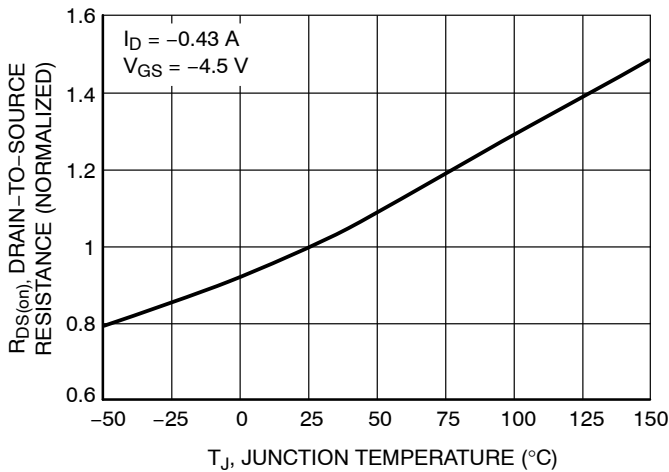

Figure 5. On-Resistance Variation with Temperature

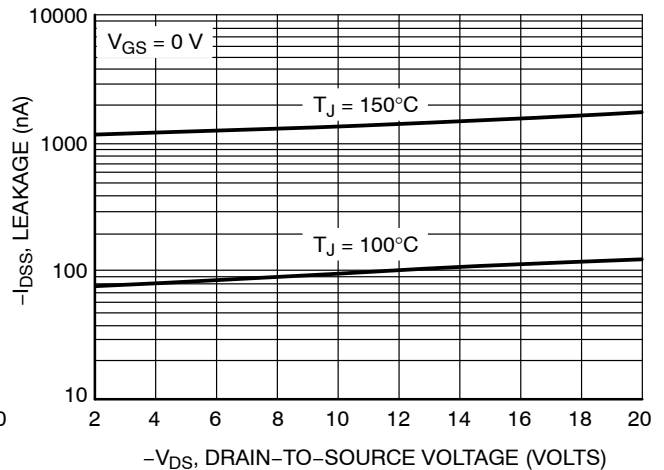

Figure 6. Drain-to-Source Leakage Current vs. Voltage

# NTZD3158P

## TYPICAL PERFORMANCE CURVES ( $T_J = 25^\circ\text{C}$ unless otherwise noted)

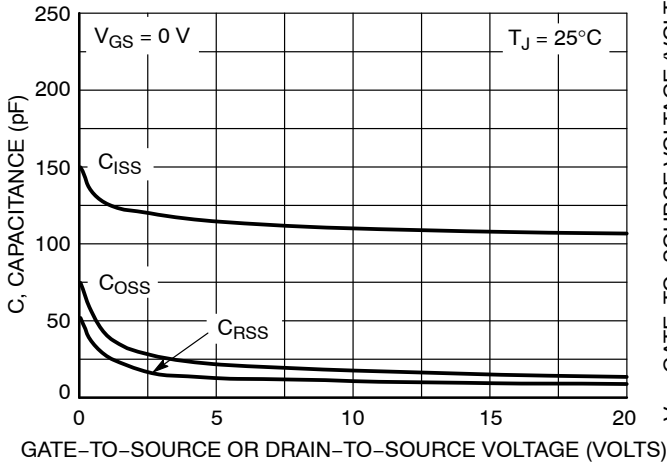

Figure 7. Capacitance Variation

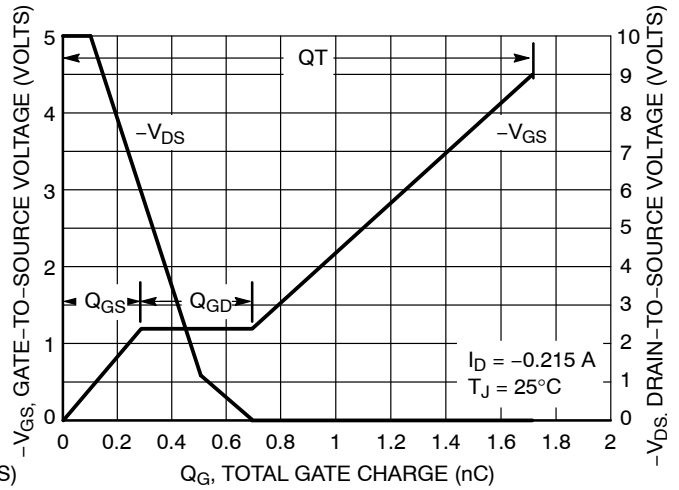

Figure 8. Gate-to-Source and Drain-to-Source Voltage vs. Total Charge

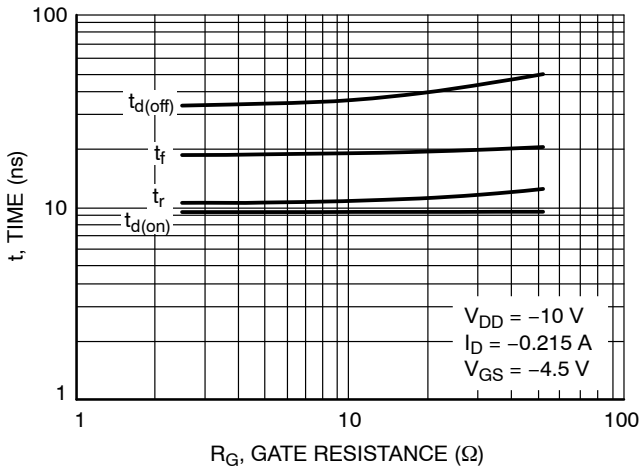

Figure 9. Resistive Switching Time Variation vs. Gate Resistance

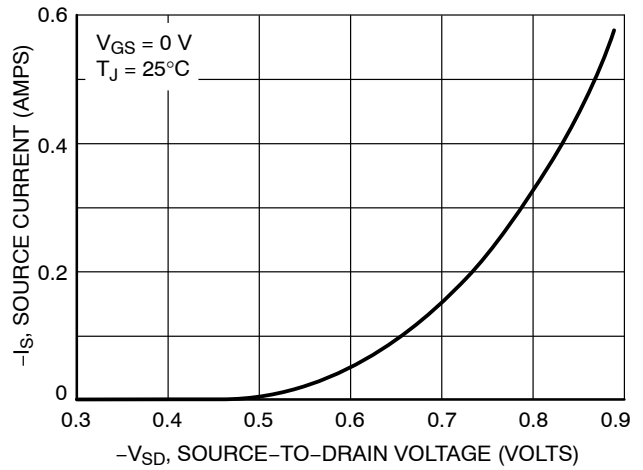
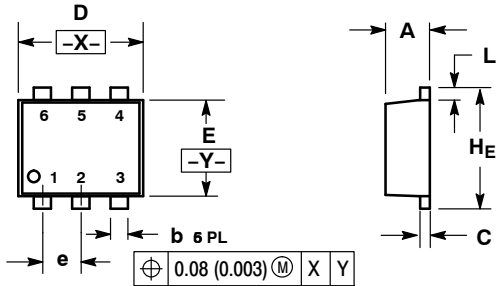

Figure 10. Diode Forward Voltage vs. Current

# NTZD3158P

## PACKAGE DIMENSIONS

### SOT-563, 6 LEAD CASE 463A ISSUE F



#### NOTES:

1. DIMENSIONING AND TOLERANCING PER ANSI Y14.5M, 1982.
2. CONTROLLING DIMENSION: MILLIMETERS
3. MAXIMUM LEAD THICKNESS INCLUDES LEAD FINISH THICKNESS. MINIMUM LEAD THICKNESS IS THE MINIMUM THICKNESS OF BASE MATERIAL.

DIM	MILLIMETERS			INCHES		
	MIN	NOM	MAX	MIN	NOM	MAX
A	0.50	0.55	0.60	0.020	0.021	0.023
b	0.17	0.22	0.27	0.007	0.009	0.011
C	0.08	0.12	0.18	0.003	0.005	0.007
D	1.50	1.60	1.70	0.059	0.062	0.066
E	1.10	1.20	1.30	0.043	0.047	0.051
e	0.5 BSC			0.02 BSC		
L	0.10	0.20	0.30	0.004	0.008	0.012
HE	1.50	1.60	1.70	0.059	0.062	0.066

#### SOLDERING FOOTPRINT\*

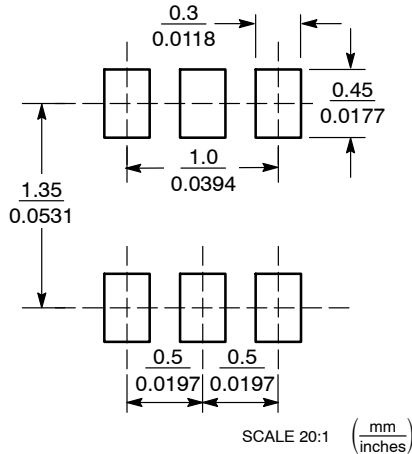

\*For additional information on our Pb-Free strategy and soldering details, please download the ON Semiconductor Soldering and Mounting Techniques Reference Manual, SOLDERRM/D.

ON Semiconductor and are registered trademarks of Semiconductor Components Industries, LLC (SCILLC). SCILLC owns the rights to a number of patents, trademarks, copyrights, trade secrets, and other intellectual property. A listing of SCILLC's product/patent coverage may be accessed at [www.onsemi.com/site/pdf/Patent-Marking.pdf](http://www.onsemi.com/site/pdf/Patent-Marking.pdf). SCILLC reserves the right to make changes without further notice to any products herein. SCILLC makes no warranty, representation or guarantee regarding the suitability of its products for any particular purpose, nor does SCILLC assume any liability arising out of the application or use of any product or circuit, and specifically disclaims any and all liability, including without limitation special, consequential or incidental damages. "Typical" parameters which may be provided in SCILLC data sheets and/or specifications can and do vary in different applications and actual performance may vary over time. All operating parameters, including "Typicals" must be validated for each customer application by customer's technical experts. SCILLC does not convey any license under its patent rights nor the rights of others. SCILLC products are not designed, intended, or authorized for use as components in systems intended for surgical implant into the body, or other applications intended to support or sustain life, or for any other application in which the failure of the SCILLC product could create a situation where personal injury or death may occur. Should Buyer purchase or use SCILLC products for any such unintended or unauthorized application, Buyer shall indemnify and hold SCILLC and its officers, employees, subsidiaries, affiliates, and distributors harmless against all claims, costs, damages, and expenses, and reasonable attorney fees arising out of, directly or indirectly, any claim of personal injury or death associated with such unintended or unauthorized use, even if such claim alleges that SCILLC was negligent regarding the design or manufacture of the part. SCILLC is an Equal Opportunity/Affirmative Action Employer. This literature is subject to all applicable copyright laws and is not for resale in any manner.

#### PUBLICATION ORDERING INFORMATION

**LITERATURE FULFILLMENT:**  
Literature Distribution Center for ON Semiconductor  
P.O. Box 5163, Denver, Colorado 80217 USA  
**Phone:** 303-675-2175 or 800-344-3860 Toll Free USA/Canada  
**Fax:** 303-675-2176 or 800-344-3867 Toll Free USA/Canada  
**Email:** [orderlit@onsemi.com](mailto:orderlit@onsemi.com)

**N. American Technical Support:** 800-282-9855 Toll Free  
USA/Canada  
**Europe, Middle East and Africa Technical Support:**  
Phone: 421 33 790 2910  
**Japan Customer Focus Center**  
Phone: 81-3-5817-1050

**ON Semiconductor Website:** [www.onsemi.com](http://www.onsemi.com)  
**Order Literature:** <http://www.onsemi.com/orderlit>

For additional information, please contact your local Sales Representative

NTZD3158P/D