

MMSZ5221BT1 Series

Preferred Device

Zener Voltage Regulators

500 mW SOD-123 Surface Mount

Three complete series of Zener diodes are offered in the convenient, surface mount plastic SOD-123 package. These devices provide a convenient alternative to the leadless 34-package style.

Features

- 500 mW Rating on FR-4 or FR-5 Board
- Wide Zener Reverse Voltage Range – 2.4 V to 110 V
- Package Designed for Optimal Automated Board Assembly
- Small Package Size for High Density Applications
- General Purpose, Medium Current
- ESD Rating of Class 3 (>16 kV) per Human Body Model
- Pb-Free Packages are Available

Mechanical Characteristics:

CASE: Void-free, transfer-molded, thermosetting plastic case

FINISH: Corrosion resistant finish, easily solderable

MAXIMUM CASE TEMPERATURE FOR SOLDERING PURPOSES:
260°C for 10 Seconds

POLARITY: Cathode indicated by polarity band

FLAMMABILITY RATING: UL 94 V-0

MAXIMUM RATINGS

Rating	Symbol	Max	Unit
Total Power Dissipation on FR-5 Board, (Note 1) @ $T_L = 75^\circ\text{C}$ Derated above 75°C	P_D	500 6.7	mW mW/ $^\circ\text{C}$
Thermal Resistance, Junction-to-Ambient (Note 2)	$R_{\theta JA}$	340	$^\circ\text{C}/\text{W}$
Thermal Resistance, Junction-to-Lead (Note 2)	$R_{\theta JL}$	150	$^\circ\text{C}/\text{W}$
Junction and Storage Temperature Range	T_J, T_{stg}	-55 to +150	$^\circ\text{C}$

Stresses exceeding Maximum Ratings may damage the device. Maximum Ratings are stress ratings only. Functional operation above the Recommended Operating Conditions is not implied. Extended exposure to stresses above the Recommended Operating Conditions may affect device reliability.

1. FR-5 = 3.5 X 1.5 inches, using the minimum recommended footprint.
2. Thermal Resistance measurement obtained via infrared Scan Method.



ON Semiconductor®

<http://onsemi.com>

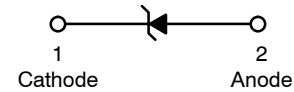

SOD-123
CASE 425
STYLE 1

MARKING DIAGRAM



xx = Device Code (Refer to page 3)
M = Date Code
▪ = Pb-Free Package
(Note: Microdot may be in either location)

ORDERING INFORMATION

Device	Package	Shipping†
MMSZ52xxBT1	SOD-123	3000/Tape & Reel
MMSZ52xxBT1G	SOD-123 (Pb-Free)	3000/Tape & Reel
MMSZ52xxBT3	SOD-123	10000/Tape & Reel
MMSZ52xxBT3G	SOD-123 (Pb-Free)	10000/Tape & Reel

†For information on tape and reel specifications, including part orientation and tape sizes, please refer to our Tape and Reel Packaging Specifications Brochure, BRD8011/D.

DEVICE MARKING INFORMATION

See specific marking information in the device marking column of the Electrical Characteristics table on page 3 of this data sheet.

Devices listed in **bold, italic** are ON Semiconductor **Preferred** devices. **Preferred** devices are recommended choices for future use and best overall value.

MMSZ5221BT1 Series

ELECTRICAL CHARACTERISTICS ($T_A = 25^\circ\text{C}$ unless otherwise noted, $V_F = 0.95\text{ V Max. @ } I_F = 10\text{ mA}$)

Symbol	Parameter
V_Z	Reverse Zener Voltage @ I_{ZT}
I_{ZT}	Reverse Current
Z_{ZT}	Maximum Zener Impedance @ I_{ZT}
I_{ZK}	Reverse Current
Z_{ZK}	Maximum Zener Impedance @ I_{ZK}
I_R	Reverse Leakage Current @ V_R
V_R	Reverse Voltage
I_F	Forward Current
V_F	Forward Voltage @ I_F

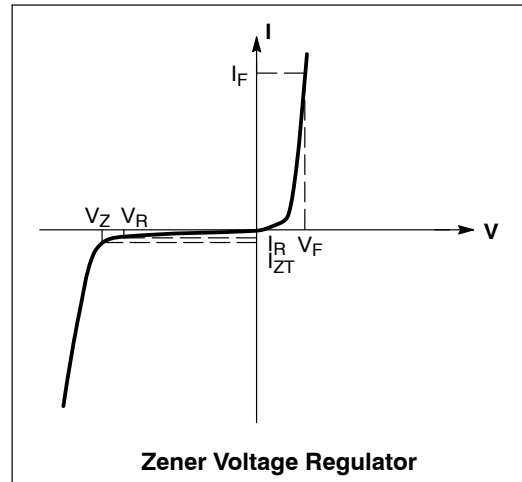

MMSZ5221BT1 Series

ELECTRICAL CHARACTERISTICS ($T_A = 25^\circ\text{C}$ unless otherwise noted, $V_F = 0.9\text{ V Max. @ } I_F = 10\text{ mA}$)

Device	Device Marking	Zener Voltage (Notes 3 and 4)				Zener Impedance (Note 5)			Leakage Current	
		V_Z (Volts)			@ I_{ZT}	Z_{ZT} @ I_{ZT}	Z_{ZK} @ I_{ZK}		I_R @ V_R	
		Min	Nom	Max	mA	Ω	Ω	mA	μA	Volts
MMSZ5221BT1, G	C1	2.28	2.4	2.52	20	30	1200	0.25	100	1
MMSZ5222BT1, G	C2	2.38	2.5	2.63	20	30	1250	0.25	100	1
MMSZ5223BT1, G	C3	2.57	2.7	2.84	20	30	1300	0.25	75	1
MMSZ5224BT1, G	C4	2.66	2.8	2.94	20	30	1400	0.25	75	1
MMSZ5225BT1, G	C5	2.85	3.0	3.15	20	29	1600	0.25	50	1
MMSZ5226BT1, G	D1	3.14	3.3	3.47	20	28	1600	0.25	25	1
MMSZ5227BT1, G	D2	3.42	3.6	3.78	20	24	1700	0.25	15	1
MMSZ5228BT1, G	D3	3.71	3.9	4.10	20	23	1900	0.25	10	1
MMSZ5229BT1, G	D4	4.09	4.3	4.52	20	22	2000	0.25	5	1
MMSZ5230BT1, G	D5	4.47	4.7	4.94	20	19	1900	0.25	5	2
MMSZ5231BT1, G	E1	4.85	5.1	5.36	20	17	1600	0.25	5	2
MMSZ5232BT1, G	E2	5.32	5.6	5.88	20	11	1600	0.25	5	3
MMSZ5233BT1, G	E3	5.70	6.0	6.30	20	7	1600	0.25	5	3.5
MMSZ5234BT1, G	E4	5.89	6.2	6.51	20	7	1000	0.25	5	4
MMSZ5235BT1, G	E5	6.46	6.8	7.14	20	5	750	0.25	3	5
MMSZ5236BT1, G	F1	7.13	7.5	7.88	20	6	500	0.25	3	6
MMSZ5237BT1, G	F2	7.79	8.2	8.61	20	8	500	0.25	3	6.5
MMSZ5238BT1, G	F3	8.27	8.7	9.14	20	8	600	0.25	3	6.5
MMSZ5239BT1, G	F4	8.65	9.1	9.56	20	10	600	0.25	3	7
MMSZ5240BT1, G	F5	9.50	10	10.50	20	17	600	0.25	3	8
MMSZ5241BT1, G	H1	10.45	11	11.55	20	22	600	0.25	2	8.4
MMSZ5242BT1, G	H2	11.40	12	12.60	20	30	600	0.25	1	9.1
MMSZ5243BT1, G	H3	12.35	13	13.65	9.5	13	600	0.25	0.5	9.9
MMSZ5244BT1, G	H4	13.30	14	14.70	9.0	15	600	0.25	0.1	10
MMSZ5245BT1, G	H5	14.25	15	15.75	8.5	16	600	0.25	0.1	11
MMSZ5246BT1, G	J1	15.20	16	16.80	7.8	17	600	0.25	0.1	12
MMSZ5247BT1, G	J2	16.15	17	17.85	7.4	19	600	0.25	0.1	13
MMSZ5248BT1, G	J3	17.10	18	18.90	7.0	21	600	0.25	0.1	14
MMSZ5249BT1, G	J4	18.05	19	19.95	6.6	23	600	0.25	0.1	14
MMSZ5250BT1, G	J5	19.00	20	21.00	6.2	25	600	0.25	0.1	15
MMSZ5251BT1, G	K1	20.90	22	23.10	5.6	29	600	0.25	0.1	17
MMSZ5252BT1, G	K2	22.80	24	25.20	5.2	33	600	0.25	0.1	18
MMSZ5253BT1, G	K3	23.75	25	26.25	5.0	35	600	0.25	0.1	19
MMSZ5254BT1, G	K4	25.65	27	28.35	4.6	41	600	0.25	0.1	21
MMSZ5255BT1, G	K5	26.60	28	29.40	4.5	44	600	0.25	0.1	21
MMSZ5256BT1, G	M1	28.50	30	31.50	4.2	49	600	0.25	0.1	23
MMSZ5257BT1, G	M2	31.35	33	34.65	3.8	58	700	0.25	0.1	25
MMSZ5258BT1, G	M3	34.20	36	37.80	3.4	70	700	0.25	0.1	27
MMSZ5259BT1, G	M4	37.05	39	40.95	3.2	80	800	0.25	0.1	30
MMSZ5260BT1, G	M5	40.85	43	45.15	3.0	93	900	0.25	0.1	33
MMSZ5261BT1, G	N1	44.65	47	49.35	2.7	105	1000	0.25	0.1	36
MMSZ5262BT1, G	N2	48.45	51	53.55	2.5	125	1100	0.25	0.1	39
MMSZ5263BT1, G	N3	53.20	56	58.80	2.2	150	1300	0.25	0.1	43
MMSZ5264BT1, G	N4	57.00	60	63.00	2.1	170	1400	0.25	0.1	46
MMSZ5265BT1, G	N5	58.90	62	65.10	2.0	185	1400	0.25	0.1	47
MMSZ5266BT1, G	P1	64.60	68	71.40	1.8	230	1600	0.25	0.1	52
MMSZ5267BT1, G	P2	71.25	75	78.75	1.7	270	1700	0.25	0.1	56
MMSZ5268BT1, G	P3	77.90	82	86.10	1.5	330	2000	0.25	0.1	62
MMSZ5269BT1	P4	82.65	87	91.35	1.4	370	2200	0.25	0.1	68
MMSZ5270BT1, G	P5	86.45	91	95.55	1.4	400	2300	0.25	0.1	69
MMSZ5272BT1, G	R2	104.5	110	115.5	1.1	750	3000	0.25	0.1	84

3. The type numbers shown have a standard tolerance of $\pm 5\%$ on the nominal Zener voltage.

4. Nominal Zener voltage is measured with the device junction in thermal equilibrium at $T_L = 30^\circ\text{C} \pm 1^\circ\text{C}$.

5. Z_{ZT} and Z_{ZK} are measured by dividing the AC voltage drop across the device by the ac current applied.

The specified limits are for $I_{Z(AC)} = 0.1 I_{Z(dc)}$ with the AC frequency = 1 KHz.

*The "G" suffix indicates Pb-Free package available.

MMSZ5221BT1 Series

TYPICAL CHARACTERISTICS

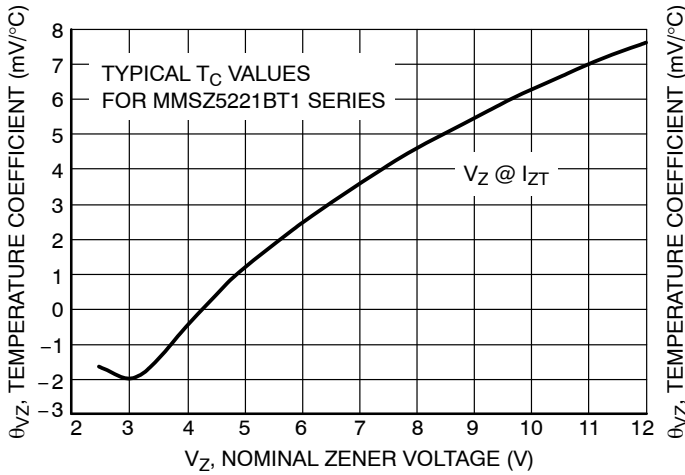

Figure 1. Temperature Coefficients (Temperature Range -55°C to +150°C)

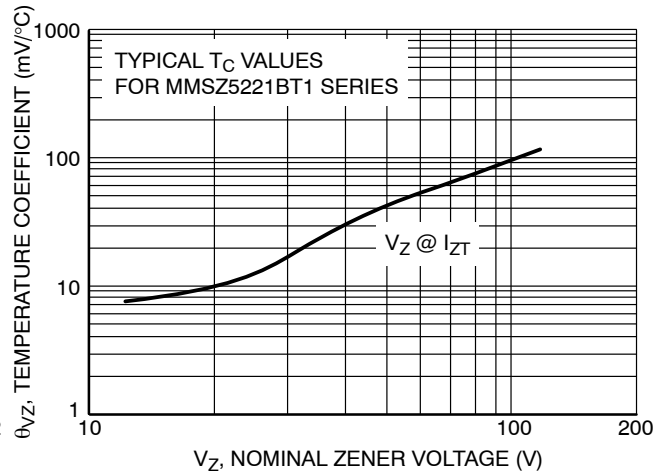

Figure 2. Temperature Coefficients (Temperature Range -55°C to +150°C)

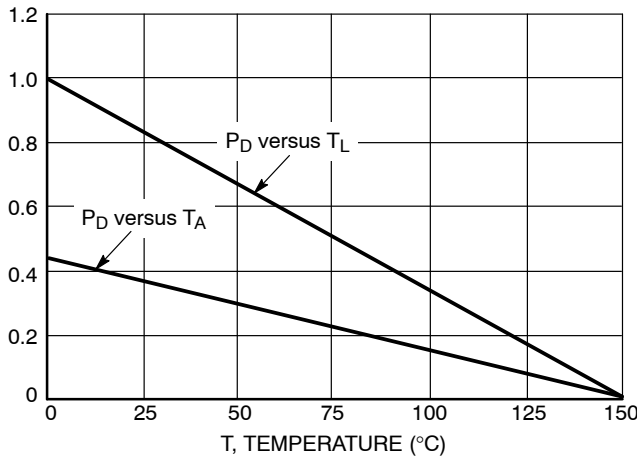

Figure 3. Steady State Power Derating

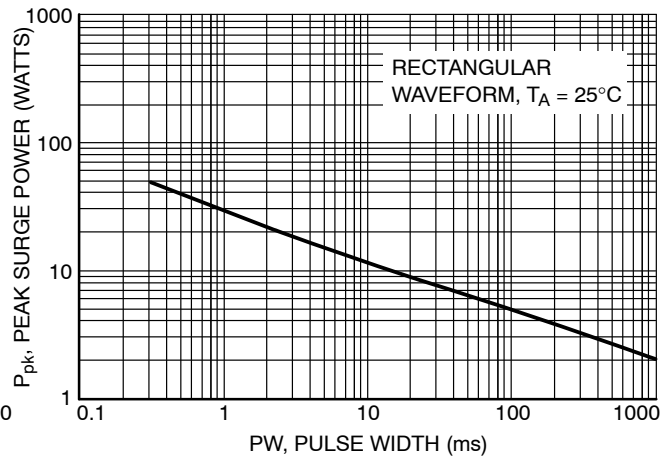

Figure 4. Maximum Nonrepetitive Surge Power

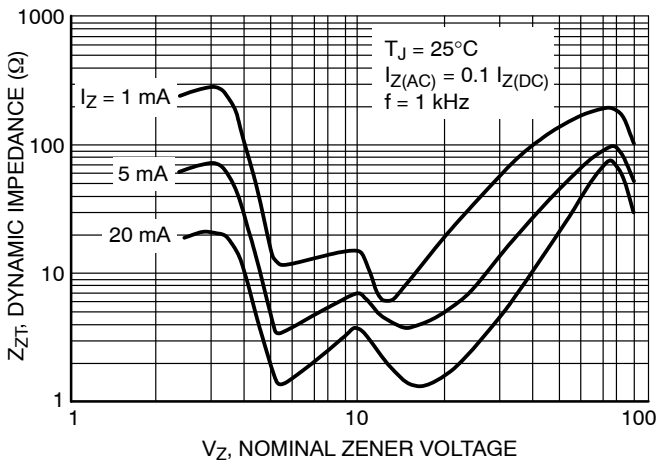

Figure 5. Effect of Zener Voltage on Zener Impedance

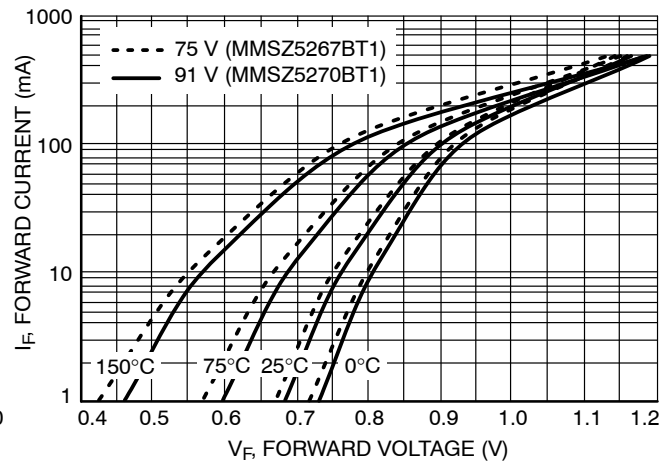

Figure 6. Typical Forward Voltage

MMSZ5221BT1 Series

TYPICAL CHARACTERISTICS

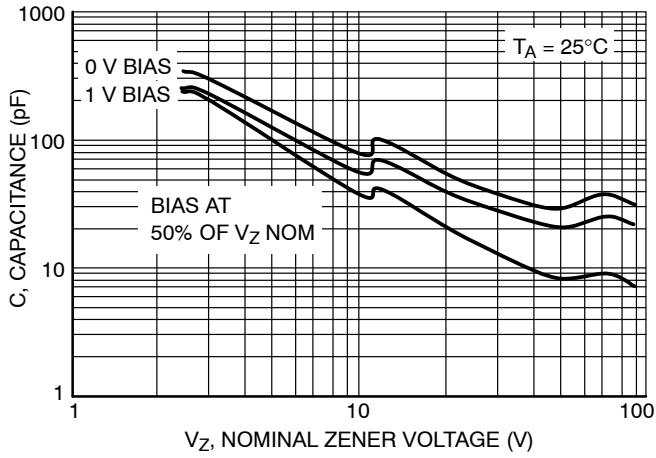

Figure 7. Typical Capacitance

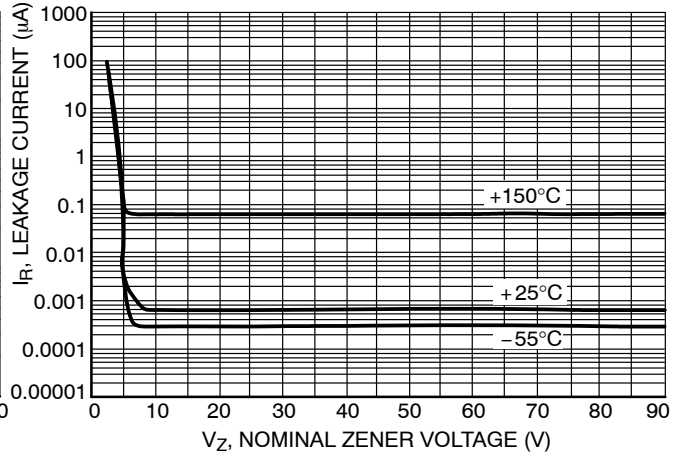

Figure 8. Typical Leakage Current

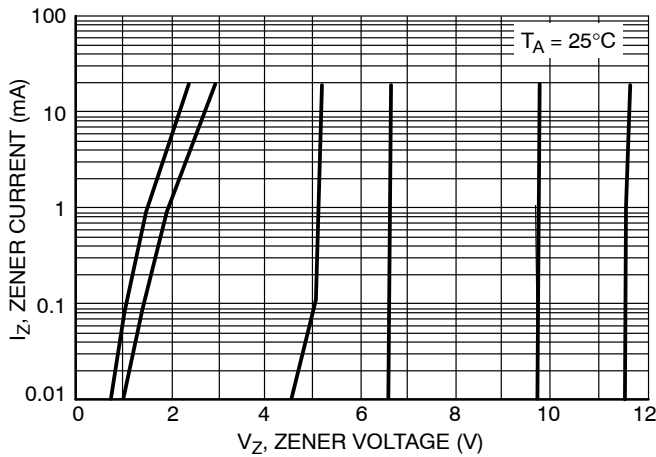

Figure 9. Zener Voltage versus Zener Current
(V_Z Up to 12 V)

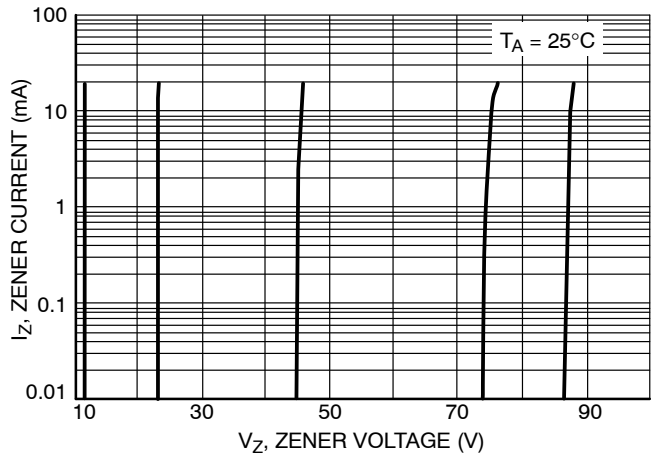
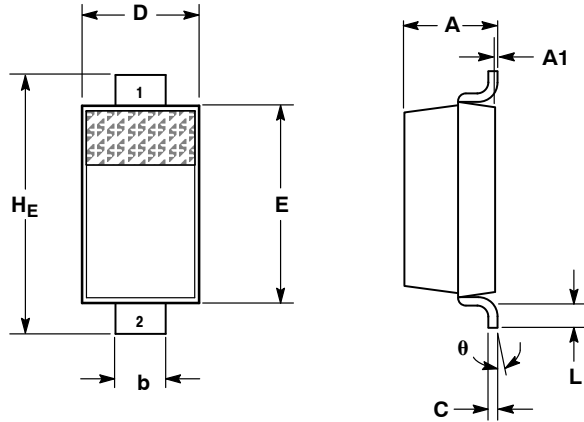

Figure 10. Zener Voltage versus Zener Current
(12 V to 91 V)

MMSZ5221BT1 Series

PACKAGE DIMENSIONS

SOD-123
CASE 425-04
ISSUE G



- NOTES:
1. DIMENSIONING AND TOLERANCING PER ANSI Y14.5M, 1982.
2. CONTROLLING DIMENSION: INCH.

DIM	MILLIMETERS			INCHES		
	MIN	NOM	MAX	MIN	NOM	MAX
A	0.94	1.17	1.35	0.037	0.046	0.053
A1	0.00	0.05	0.10	0.000	0.002	0.004
b	0.51	0.61	0.71	0.020	0.024	0.028
c	---	---	0.15	---	---	0.006
D	1.40	1.60	1.80	0.055	0.063	0.071
E	2.54	2.69	2.84	0.100	0.106	0.112
H _E	3.56	3.68	3.86	0.140	0.145	0.152
L	0.25	---	---	0.010	---	---
θ	0°	---	10°	0°	---	10°

STYLE 1:
PIN 1. CATHODE
2. ANODE

SOLDERING FOOTPRINT*

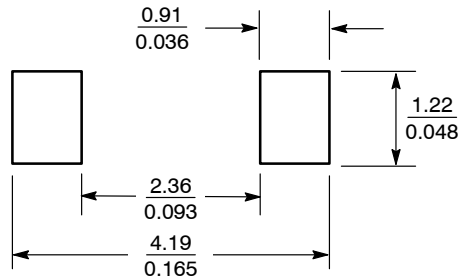

SCALE 10:1 ($\frac{\text{mm}}{\text{inches}}$)

*For additional information on our Pb-Free strategy and soldering details, please download the ON Semiconductor Soldering and Mounting Techniques Reference Manual, SOLDERRM/D.

ON Semiconductor and are registered trademarks of Semiconductor Components Industries, LLC (SCILLC). SCILLC reserves the right to make changes without further notice to any products herein. SCILLC makes no warranty, representation or guarantee regarding the suitability of its products for any particular purpose, nor does SCILLC assume any liability arising out of the application or use of any product or circuit, and specifically disclaims any and all liability, including without limitation special, consequential or incidental damages. "Typical" parameters which may be provided in SCILLC data sheets and/or specifications can and do vary in different applications and actual performance may vary over time. All operating parameters, including "Typicals" must be validated for each customer application by customer's technical experts. SCILLC does not convey any license under its patent rights nor the rights of others. SCILLC products are not designed, intended, or authorized for use as components in systems intended for surgical implant into the body, or other applications intended to support or sustain life, or for any other application in which the failure of the SCILLC product could create a situation where personal injury or death may occur. Should Buyer purchase or use SCILLC products for any such unintended or unauthorized application, Buyer shall indemnify and hold SCILLC and its officers, employees, subsidiaries, affiliates, and distributors harmless against all claims, costs, damages, and expenses, and reasonable attorney fees arising out of, directly or indirectly, any claim of personal injury or death associated with such unintended or unauthorized use, even if such claim alleges that SCILLC was negligent regarding the design or manufacture of the part. SCILLC is an Equal Opportunity/Affirmative Action Employer. This literature is subject to all applicable copyright laws and is not for resale in any manner.

PUBLICATION ORDERING INFORMATION

LITERATURE FULFILLMENT:
Literature Distribution Center for ON Semiconductor
P.O. Box 5163, Denver, Colorado 80217 USA
Phone: 303-675-2175 or 800-344-3860 Toll Free USA/Canada
Fax: 303-675-2176 or 800-344-3867 Toll Free USA/Canada
Email: orderlit@onsemi.com

N. American Technical Support: 800-282-9855 Toll Free
USA/Canada
Europe, Middle East and Africa Technical Support:
Phone: 421 33 790 2910
Japan Customer Focus Center
Phone: 81-3-5773-3850

ON Semiconductor Website: www.onsemi.com
Order Literature: <http://www.onsemi.com/orderlit>
For additional information, please contact your local Sales Representative

MMSZ5221BT1/D