

ON Semiconductor

Is Now

The logo for onsemi, featuring the word "onsemi" in a dark teal, lowercase, sans-serif font. The letter "i" is stylized with a white dot and a teal vertical bar. A small orange triangle is positioned above the top right of the "i". A trademark symbol (TM) is located to the right of the logo.

To learn more about onsemi™, please visit our website at
www.onsemi.com

onsemi and **onsemi** and other names, marks, and brands are registered and/or common law trademarks of Semiconductor Components Industries, LLC dba "**onsemi**" or its affiliates and/or subsidiaries in the United States and/or other countries. **onsemi** owns the rights to a number of patents, trademarks, copyrights, trade secrets, and other intellectual property. A listing of **onsemi** product/patent coverage may be accessed at www.onsemi.com/site/pdf/Patent-Marking.pdf. **onsemi** reserves the right to make changes at any time to any products or information herein, without notice. The information herein is provided "as-is" and **onsemi** makes no warranty, representation or guarantee regarding the accuracy of the information, product features, availability, functionality, or suitability of its products for any particular purpose, nor does **onsemi** assume any liability arising out of the application or use of any product or circuit, and specifically disclaims any and all liability, including without limitation special, consequential or incidental damages. Buyer is responsible for its products and applications using **onsemi** products, including compliance with all laws, regulations and safety requirements or standards, regardless of any support or applications information provided by **onsemi**. "Typical" parameters which may be provided in **onsemi** data sheets and/or specifications can and do vary in different applications and actual performance may vary over time. All operating parameters, including "Typicals" must be validated for each customer application by customer's technical experts. **onsemi** does not convey any license under any of its intellectual property rights nor the rights of others. **onsemi** products are not designed, intended, or authorized for use as a critical component in life support systems or any FDA Class 3 medical devices or medical devices with a same or similar classification in a foreign jurisdiction or any devices intended for implantation in the human body. Should Buyer purchase or use **onsemi** products for any such unintended or unauthorized application, Buyer shall indemnify and hold **onsemi** and its officers, employees, subsidiaries, affiliates, and distributors harmless against all claims, costs, damages, and expenses, and reasonable attorney fees arising out of, directly or indirectly, any claim of personal injury or death associated with such unintended or unauthorized use, even if such claim alleges that **onsemi** was negligent regarding the design or manufacture of the part. **onsemi** is an Equal Opportunity/Affirmative Action Employer. This literature is subject to all applicable copyright laws and is not for resale in any manner. Other names and brands may be claimed as the property of others.

MOSFET – Power, Single N-Channel, DFNW8

150 V, 6.4 mΩ, 128 A



ON Semiconductor®

www.onsemi.com

NVMTS6D0N15MC

Features

- Small Footprint (8x8 mm) for Compact Design
- Low $R_{DS(on)}$ to Minimize Conduction Losses
- Low Q_G and Capacitance to Minimize Driver Losses
- AEC-Q101 Qualified and PPAP Capable
- These Devices are Pb-Free, Halogen Free/BFR Free and are RoHS Compliant

MAXIMUM RATINGS ($T_J = 25^\circ\text{C}$ unless otherwise noted)

Symbol	Parameter		Value	Unit	
V_{DSS}	Drain-to-Source Voltage		150	V	
V_{GS}	Gate-to-Source Voltage		± 20	V	
I_D	Continuous Drain Current $R_{\theta JC}$ (Note 2)	Steady State	$T_C = 25^\circ\text{C}$	128	A
P_D				Power Dissipation $R_{\theta JC}$ (Note 2)	237
I_D	Continuous Drain Current $R_{\theta JC}$ (Note 2)	Steady State	$T_C = 100^\circ\text{C}$	90	A
P_D				Power Dissipation $R_{\theta JC}$ (Note 2)	119
I_D	Continuous Drain Current $R_{\theta JA}$ (Notes 1, 2)	Steady State	$T_A = 25^\circ\text{C}$	18	A
P_D				Power Dissipation $R_{\theta JA}$ (Notes 1, 2)	5
I_D	Continuous Drain Current $R_{\theta JA}$ (Notes 1, 2)	Steady State	$T_A = 100^\circ\text{C}$	13	A
P_D				Power Dissipation $R_{\theta JA}$ (Notes 1, 2)	2.4
I_{DM}	Pulsed Drain Current	$T_A = 25^\circ\text{C}, t_p = 10 \mu\text{s}$	900	A	
T_J, T_{stg}	Operating Junction and Storage Temperature Range		-55 to 175	$^\circ\text{C}$	
I_S	Source Current (Body Diode)		198	A	
E_{AS}	Single Pulse Drain-to-Source Avalanche Energy ($I_L = 10.2 \text{ A}_{pk}$)		2376	mJ	
T_L	Lead Temperature Soldering Reflow for Soldering Purposes (1/8" from case for 10 s)		260	$^\circ\text{C}$	

Stresses exceeding those listed in the Maximum Ratings table may damage the device. If any of these limits are exceeded, device functionality should not be assumed, damage may occur and reliability may be affected.

1. Surface-mounted on FR4 board using 1 in² pad size, 1 oz Cu pad.
2. The entire application environment impacts the thermal resistance values shown, they are not constants and are only valid for the particular conditions noted

$V_{(BR)DSS}$	$R_{DS(ON)} \text{ MAX}$	$I_D \text{ MAX}$
150 V	6.4 mΩ @ 10 V	128 A

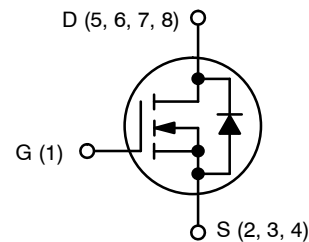

N-CHANNEL MOSFET

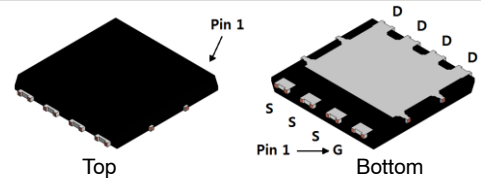

DFNW8 8.3x8.4, 2P
PQFN88
CASE 507AP

MARKING DIAGRAM

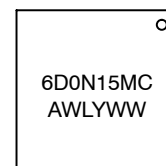

6D0N15MC = Specific Device Code
A = Assembly Location
WL = Wafer Lot Code
Y = Year Code
W = Work Week Code

ORDERING INFORMATION

Device	Package	Shipping†
NVMTS6D0N15MC	DFNW8 PQFN88 (Pb-Free)	3000 / Tape & Reel

†For information on tape and reel specifications, including part orientation and tape sizes, please refer to our Tape and Reel Packaging Specifications Brochure, BRD8011/D.

NVMTS6D0N15MC

THERMAL RESISTANCE RATINGS

Symbol	Parameter	Max	Unit
$R_{\theta JC}$	Junction-to-Case – Steady State (Note 2)	0.63	°C/W
$R_{\theta JA}$	Junction-to-Ambient – Steady State (Note 2)	31.6	

ELECTRICAL CHARACTERISTICS ($T_J = 25^\circ\text{C}$ unless otherwise noted)

Symbol	Parameter	Test Condition	Min	Typ	Max	Unit
--------	-----------	----------------	-----	-----	-----	------

OFF CHARACTERISTICS

$V_{(BR)DSS}$	Drain-to-Source Breakdown Voltage	$V_{GS} = 0\text{ V}, I_D = 250\ \mu\text{A}$	150	–	–	V	
$V_{(BR)DSS} / T_J$	Drain-to-Source Breakdown Voltage Temperature Coefficient	$I_D = 250\ \mu\text{A}$, ref to 25°C	–	58.67	–	mV/°C	
I_{DSS}	Zero Gate Voltage Drain Current	$V_{GS} = 0\text{ V}, V_{DS} = 120\text{ V}$	$T_J = 25^\circ\text{C}$	–	–	1	μA
			$T_J = 125^\circ\text{C}$	–	–	10	μA
I_{GSS}	Gate-to-Source Leakage Current	$V_{DS} = 0\text{ V}, V_{GS} = \pm 20\text{ V}$	–	–	± 100	nA	

ON CHARACTERISTICS (Note 3)

$V_{GS(TH)}$	Gate Threshold Voltage	$V_{GS} = V_{DS}, I_D = 379\ \mu\text{A}$	2.5	3.6	4.5	V
$V_{GS(TH)} / T_J$	Negative Threshold Temperature Coefficient	$I_D = 250\ \mu\text{A}$, ref to 25°C	–	–9.14	–	mV/°C
$R_{DS(on)}$	Drain-to-Source On Resistance	$V_{GS} = 10\text{ V}, I_D = 69\text{ A}$	–	4.6	6.4	m Ω
g_{FS}	Forward Transconductance	$V_{DS} = 5\text{ V}, I_D = 69\text{ A}$	–	127	–	S
R_G	Gate-Resistance	$T_A = 25^\circ\text{C}$	–	1.1	–	Ω

CHARGES & CAPACITANCES

C_{ISS}	Input Capacitance	$V_{GS} = 0\text{ V}, f = 1\text{ MHz}, V_{DS} = 75\text{ V}$	–	4815	–	pF
C_{OSS}	Output Capacitance		–	1482	–	
C_{RSS}	Reverse Transfer Capacitance		–	9.7	–	
$Q_{G(TOT)}$	Total Gate Charge	$V_{GS} = 10\text{ V}, V_{DS} = 75\text{ V}, I_D = 69\text{ A}$	–	58	–	nC
$Q_{G(TH)}$	Threshold Gate Charge		–	34	–	
Q_{GS}	Gate-to-Source Charge		–	26	–	
Q_{GD}	Gate-to-Drain Charge		–	8	–	
Q_{OSS}	Output Charge	$V_{GS} = 0\text{ V}, V_{DS} = 75\text{ V}$	–	173	–	nC

SWITCHING CHARACTERISTICS, $V_{GS} = 10\text{ V}$ (Note 3)

$t_{d(ON)}$	Turn-On Delay Time	$V_{GS} = 10\text{ V}, V_{DS} = 75\text{ V}, I_D = 69\text{ A}, R_G = 6\ \Omega$	–	30	–	ns
t_r	Rise Time		–	7	–	
$t_{d(OFF)}$	Turn-Off Delay Time		–	38	–	
t_f	Fall Time		–	6	–	

DRAIN-SOURCE DIODE CHARACTERISTICS

V_{SD}	Forward Diode Voltage	$V_{GS} = 0\text{ V}, I_S = 69\text{ A}$	$T_J = 25^\circ\text{C}$	–	0.87	1.2	V
			$T_J = 125^\circ\text{C}$	–	0.70	–	
t_{RR}	Reverse Recovery Time	$V_{GS} = 0\text{ V}, dI_S/dt = 100\text{ A}/\mu\text{s}, I_S = 69\text{ A}$	–	72	–	ns	
t_a	Charge Time		–	49	–		
t_b	Discharge Time		–	23	–		
Q_{RR}	Reverse Recovery Charge		–	125	–		nC

Product parametric performance is indicated in the Electrical Characteristics for the listed test conditions, unless otherwise noted. Product performance may not be indicated by the Electrical Characteristics if operated under different conditions.

3. Switching characteristics are independent of operating junction temperatures

NVMTS6D0N15MC

TYPICAL CHARACTERISTICS

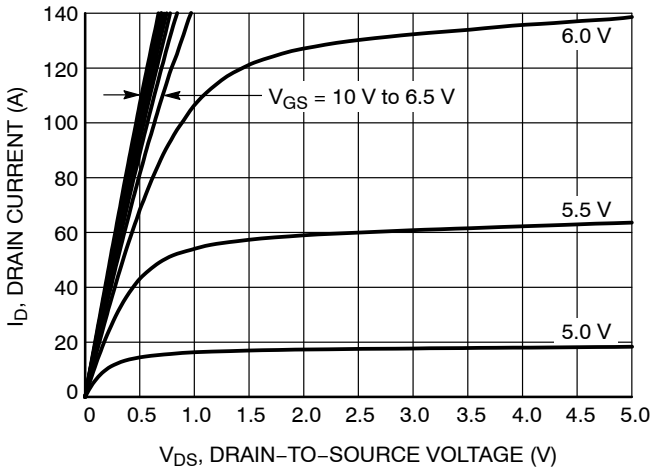

Figure 1. On-Region Characteristics

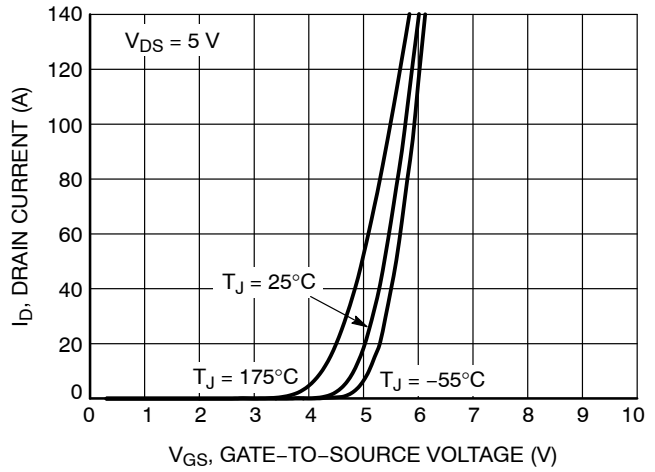

Figure 2. Transfer Characteristics

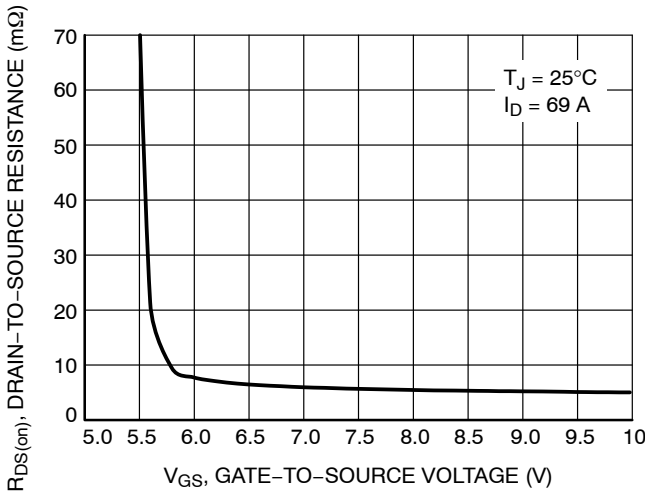

Figure 3. On-Resistance vs. Gate-to-Source Voltage

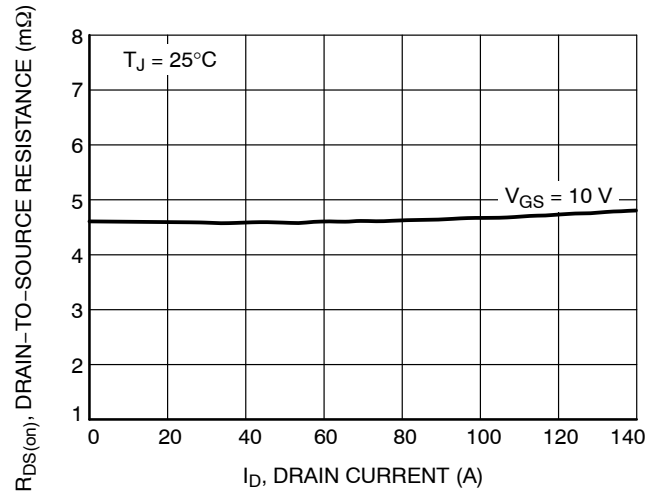

Figure 4. On-Resistance vs. Drain Current and Gate Voltage

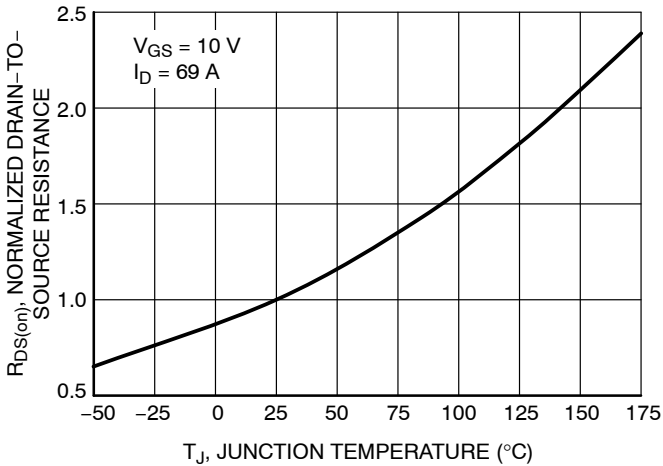

Figure 5. On-Resistance Variation with Temperature

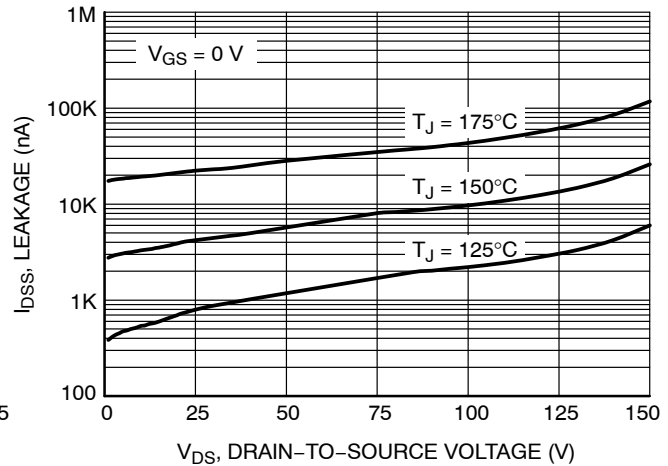

Figure 6. Drain-to-Source Leakage Current vs. Voltage

NVMTS6D0N15MC

TYPICAL CHARACTERISTICS

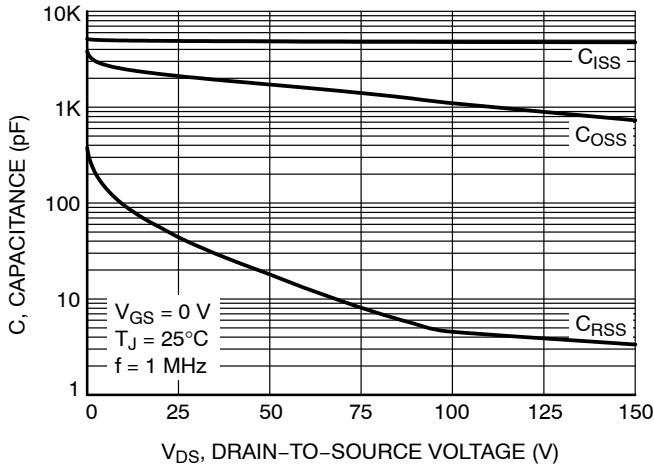

Figure 7. Capacitance Variation

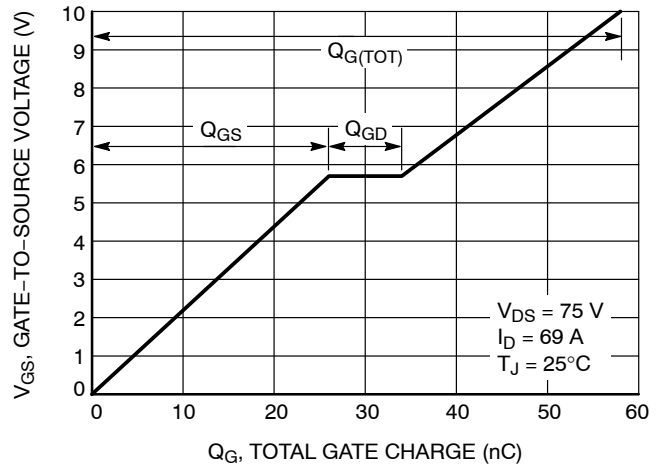

Figure 8. Gate-to-Source and Drain-to-Source Voltage vs. Total Charge

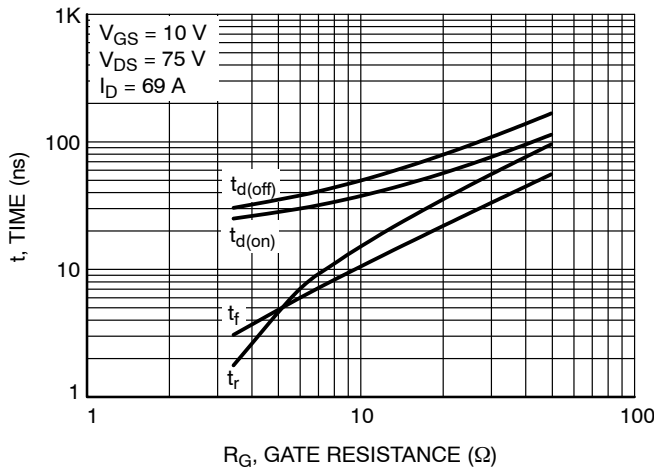

Figure 9. Resistive Switching Time Variation vs. Gate Resistance

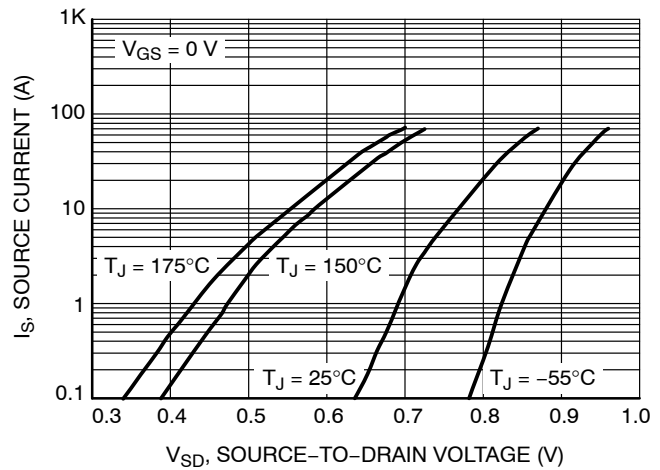

Figure 10. Diode Forward Voltage vs. Current

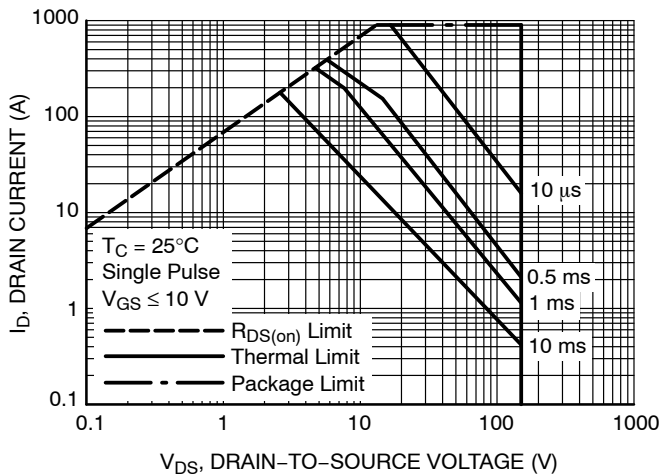

Figure 11. Safe Operating Area

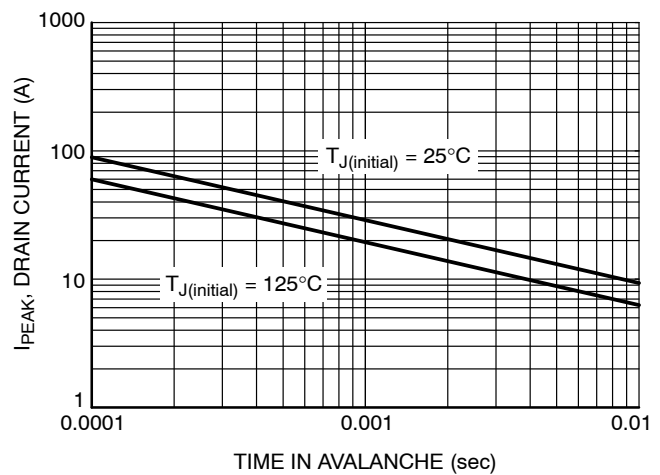

Figure 12. I_{PEAK} vs. Time in Avalanche

NVMTS6D0N15MC

TYPICAL CHARACTERISTICS

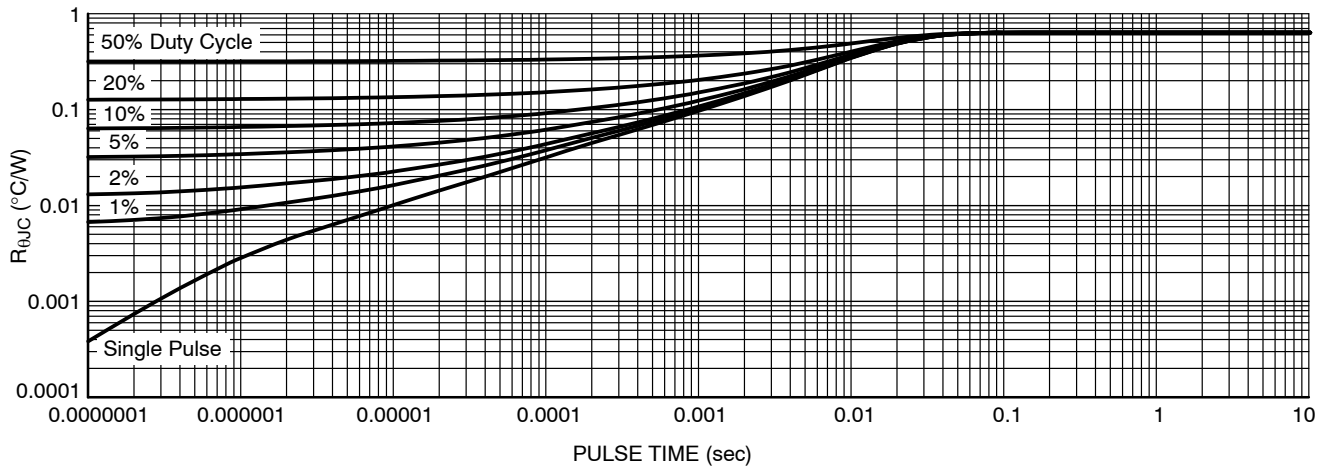

Figure 13. Thermal Characteristics

NVMTS6D0N15MC

PACKAGE DIMENSIONS

DFNW8 8.3x8.4, 2P
CASE 507AP
ISSUE A

DATE 14 AUG 2018

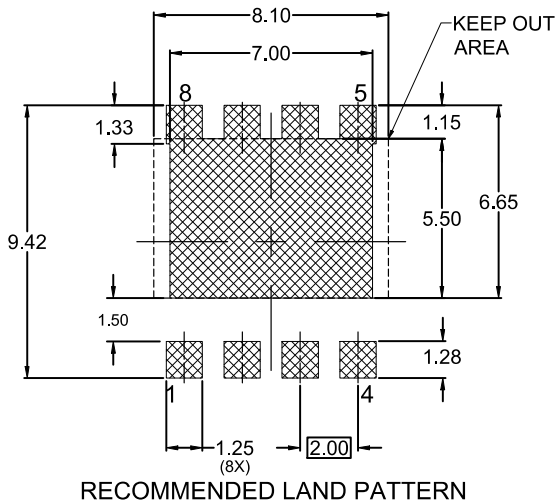
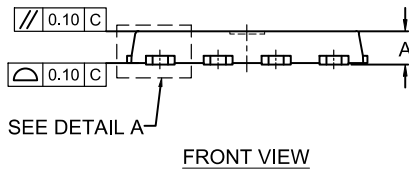
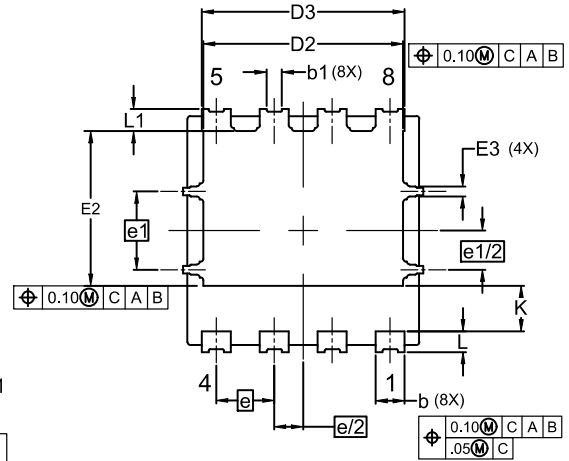
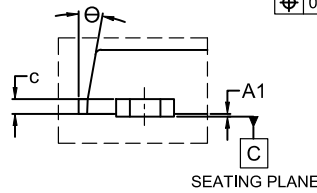
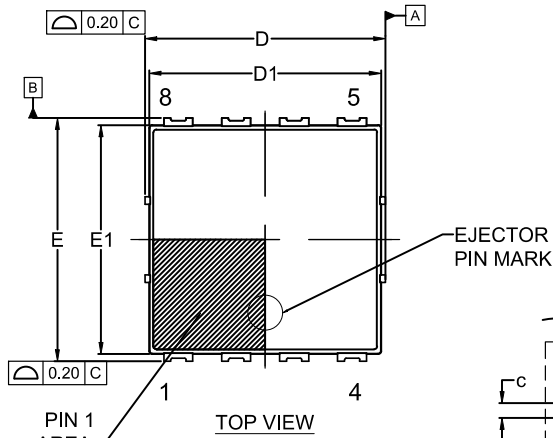

NOTES:

1. DIMENSIONING AND TOLERANCING PER ASME Y14.5M, 2009.
2. CONTROLLING DIMENSION: MILLIMETERS
3. COPLANARITY APPLIES TO THE EXPOSED PADS AS WELL AS THE TERMINALS.
4. DIMENSIONS D1 AND E1 DO NOT INCLUDE MOLD FLASH, PROTRUSIONS, OR GATE BURRS.
5. SEATING PLANE IS DEFINED BY THE TERMINALS. "A1" IS DEFINED AS THE DISTANCE FROM THE SEATING PLANE TO THE LOWEST POINT ON THE PACKAGE BODY.

DIM	MILLIMETERS		
	MIN.	NOM.	MAX.
A	1.00	1.10	1.20
A1	0.00	--	0.05
b	0.90	1.00	1.10
b1	0.43	0.53	0.63
c	0.23	0.28	0.33
D	8.20	8.30	8.40
D1	7.90	8.00	8.10
D2	6.80	6.90	7.00
D3	6.90	7.00	7.10
E	8.30	8.40	8.50
E1	7.80	7.90	8.00
E2	5.24	5.34	5.44
E3	0.25	0.35	0.45
e	2.00 BSC		
e/2	1.00 BSC		
e1	2.70 BSC		
e1/2	1.35 BSC		
K	1.50	1.57	1.70
L	0.64	0.74	0.84
L1	0.67	0.77	0.87
θ	0°	--	12°

NVMTS6D0N15MC

ON Semiconductor and  are trademarks of Semiconductor Components Industries, LLC dba ON Semiconductor or its subsidiaries in the United States and/or other countries. ON Semiconductor owns the rights to a number of patents, trademarks, copyrights, trade secrets, and other intellectual property. A listing of ON Semiconductor's product/patent coverage may be accessed at www.onsemi.com/site/pdf/Patent-Marking.pdf. ON Semiconductor reserves the right to make changes without further notice to any products herein. ON Semiconductor makes no warranty, representation or guarantee regarding the suitability of its products for any particular purpose, nor does ON Semiconductor assume any liability arising out of the application or use of any product or circuit, and specifically disclaims any and all liability, including without limitation special, consequential or incidental damages. Buyer is responsible for its products and applications using ON Semiconductor products, including compliance with all laws, regulations and safety requirements or standards, regardless of any support or applications information provided by ON Semiconductor. "Typical" parameters which may be provided in ON Semiconductor data sheets and/or specifications can and do vary in different applications and actual performance may vary over time. All operating parameters, including "Typicals" must be validated for each customer application by customer's technical experts. ON Semiconductor does not convey any license under its patent rights nor the rights of others. ON Semiconductor products are not designed, intended, or authorized for use as a critical component in life support systems or any FDA Class 3 medical devices or medical devices with a same or similar classification in a foreign jurisdiction or any devices intended for implantation in the human body. Should Buyer purchase or use ON Semiconductor products for any such unintended or unauthorized application, Buyer shall indemnify and hold ON Semiconductor and its officers, employees, subsidiaries, affiliates, and distributors harmless against all claims, costs, damages, and expenses, and reasonable attorney fees arising out of, directly or indirectly, any claim of personal injury or death associated with such unintended or unauthorized use, even if such claim alleges that ON Semiconductor was negligent regarding the design or manufacture of the part. ON Semiconductor is an Equal Opportunity/Affirmative Action Employer. This literature is subject to all applicable copyright laws and is not for resale in any manner.

PUBLICATION ORDERING INFORMATION

LITERATURE FULFILLMENT:

Email Requests to: orderlit@onsemi.com

ON Semiconductor Website: www.onsemi.com

TECHNICAL SUPPORT

North American Technical Support:
Voice Mail: 1 800-282-9855 Toll Free USA/Canada
Phone: 011 421 33 790 2910

Europe, Middle East and Africa Technical Support:
Phone: 00421 33 790 2910

For additional information, please contact your local Sales Representative

