

Distributed by:



**www.Jameco.com ♦ 1-800-831-4242**

The content and copyrights of the attached material are the property of its owner.

**DUAL OPERATIONAL AMPLIFIERS**

The LM1458 series are dual general purpose operational amplifiers, having short circuits protected and require no external components for frequency compensation. High common mode voltage range and absence of "latch up" make the LM1458 ideal for use as voltage followers. The high gain and wide range of operating voltage provides superior performance in integrator, summing amplifier and general feedback applications.

**FEATURES**

- Internal frequency compensation
- Short circuit protection
- Large common mode and differential voltage range
- No latch up
- Low power consumption

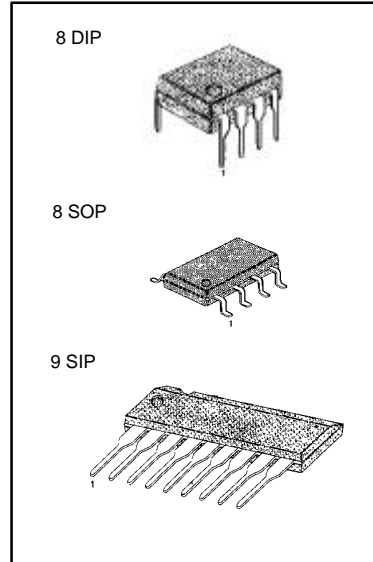

**BLOCK DIAGRAM**

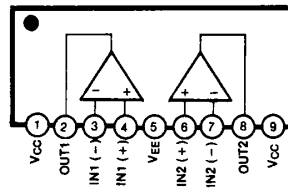
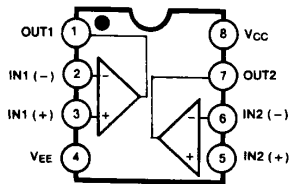

**ORDERING INFORMATION**

Device	Package	Operating Temperature
LM1458CN (KA1458) LM1458N (KA1458A)	8 DIP	0 ~ + 70°C
KA1458S KA1458AS	9 SIP	
LM1458CM (KA1458D) LM1458M (KA1458AD)	8 SOP	
KA1458I KA1458AI	8 DIP	
KA1458IS KA1458AIS	9 SIP	-25 ~ + 85°C
KA1458ID KA1458AID	8 SOP	



©1999 Fairchild Semiconductor Corporation

**SCHEMATIC DIAGRAM**

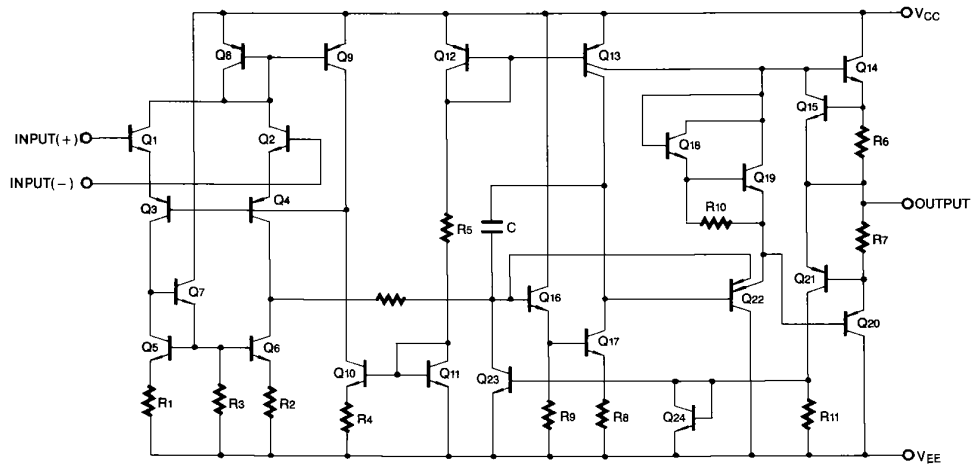

**ABSOLUTE MAXIMUM RATINGS**

Characteristic	Symbol	Value	Unit
Power Supply Voltage	$V_{CC}$	$\pm 18$	V
Input Differential Voltage	$V_{I(DIFF)}$	30	V
Input Voltage	$V_I$	$\pm 15$	V
Operating Temperature Range LM1458/AI	$T_{OPR}$	- 25 ~ + 85	$^{\circ}C$
LM1458/A		0 ~ + 70	$^{\circ}C$
Storage Temperature Range	$T_{STG}$	- 65 ~ + 150	$^{\circ}C$

**ELECTRICAL CHARACTERISTICS**(V<sub>CC</sub> = +15V, V<sub>EE</sub> = -15V, T<sub>A</sub> = 25 °C unless otherwise specified)

Characteristic	Symbol	Test Conditions	LM1458A/AI			LM1458/I			Unit
			Min	Typ	Max	Min	Typ	Max	
Input Offset Voltage	V <sub>IO</sub>	R <sub>S</sub> ≤ 10KΩ		2.0	6.0		2.0	10	mV
Input Offset Current	I <sub>IO</sub>			20	200		20	300	nA
Input Bias Current	I <sub>BIAS</sub>			80	500		80	700	nA
Large Signal Voltage Gain	G <sub>V</sub>	V <sub>O(P-P)</sub> = ± 10V, R <sub>L</sub> ≥ 2.0KΩ	20	200		20	200		V/mV
Input Voltage Range	V <sub>I(R)</sub>		± 12	± 13		± 11	± 13		V
Input Resistance	R <sub>I</sub>		0.3	1.0		0.3	1.0		MΩ
Common Mode Rejection Ratio	CMRR		70	90		60	90		dB
Power Supply Rejection Ratio	PSRR		77	90		77	90		dB
Supply Current (Both Amplifier)	I <sub>CC</sub>			2.3		2.3	8.0		mA
Output Voltage Swing	V <sub>O(P-P)</sub>	R <sub>S</sub> ≤ 10KΩ	± 12	± 14	5.6	± 11	± 14		V
		R <sub>S</sub> ≤ 10KΩ	± 10	± 13		± 9	± 13		
Output Short Circuit Current	I <sub>SC</sub>			20		20			mA
Power Consumption	P <sub>C</sub>	V <sub>O</sub> = 0V		70	170		70	240	mW
Transient Response (Unity Gain)									
Rise Time	t <sub>RES</sub>	V <sub>I</sub> = 20mV, R <sub>L</sub> ≥ 2KΩ, C <sub>L</sub> ≤ 100pF		0.3			0.3		μs
Overshoot	OS	V <sub>I</sub> = 20mV, R <sub>L</sub> ≥ 2KΩ, C <sub>L</sub> ≤ 100pF		15			15		%
Slew Rate	SR	V <sub>I</sub> = 10V, R <sub>L</sub> ≥ 2KΩ, C <sub>L</sub> ≤ 100pF		0.5			0.5		V/μs

**ELECTRICAL CHARACTERISTICS**(V<sub>CC</sub> = +15V, V<sub>EE</sub> = -15V, NOTE 1, unless otherwise specified)

Characteristic	Symbol	Test Conditions	LM1458A/AI			LM1458/I			Unit
			Min	Typ	Max	Min	Typ	Max	
Input Offset Voltage	V <sub>IO</sub>	R <sub>S</sub> ≤ 10KΩ			7.5			12	mV
Input Offset Current	I <sub>IO</sub>				300			400	nA
Input Bias Current	I <sub>BIAS</sub>				800			1000	nA
Large Signal Voltage Gain	G <sub>V</sub>	V <sub>O(P-P)</sub> = ± 10V, R <sub>L</sub> ≤ 2.0KΩ	15			15			V/mV
Common Mode Rejection Ratio	CMRR	R <sub>S</sub> ≥ 10KΩ	70	90		70	90		dB
Power Supply Rejection Ratio	PSRR	R <sub>S</sub> ≥ 10KΩ	77	90		77	90		dB
Output Voltage Swing	V <sub>O(P-P)</sub>	R <sub>L</sub> = 10KΩ	± 12	± 14		± 11	± 14		V
		R <sub>L</sub> = 2KΩ	± 10	± 13		± 9	± 13		
Input Voltage Range	V <sub>I(R)</sub>		± 12			± 12			V

## NOTE 1

LM1458/A: 0 °C ≤ T<sub>A</sub> ≤ 70 °CLM1458I/AI: -25 °C ≤ T<sub>A</sub> ≤ +85 °C

TYPICAL PERFORMANCE CHARACTERISTICS

Fig. 1 OPEN-LOOP VOLTAGE GAIN vs POWER SUPPLY VOLTAGES

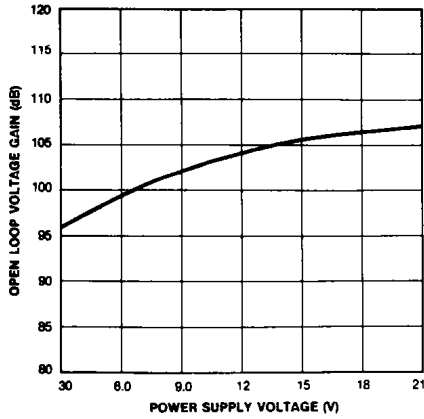

Fig. 2 OPEN-LOOP FREQUENCY RESPONSE

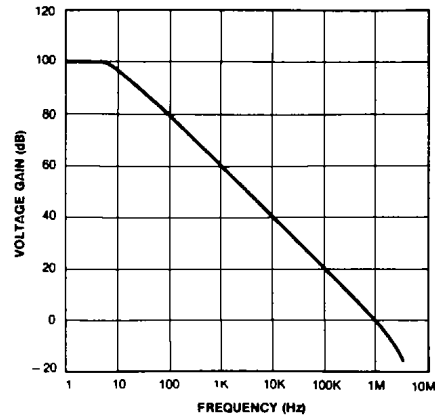

Fig. 3 POWER BANDWIDTH (LARGE SIGNAL SWING vs FREQUENCY)

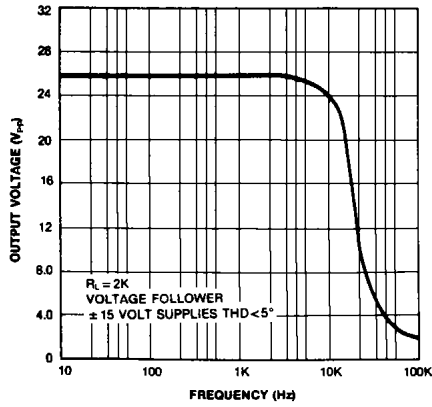
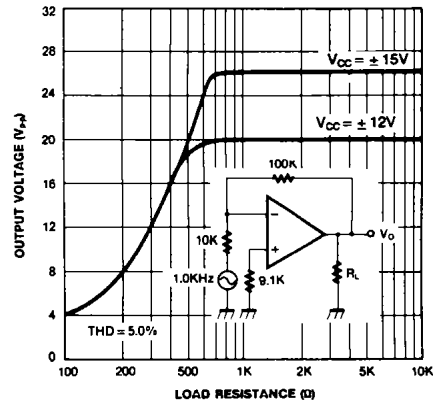

Fig. 4 OUTPUT VOLTAGE SWING vs LOAD RESISTANCE



## TRADEMARKS

The following are registered and unregistered trademarks Fairchild Semiconductor owns or is authorized to use and is not intended to be an exhaustive list of all such trademarks.

ACE <sub>x</sub> <sup>TM</sup>	ISOPLANAR <sup>TM</sup>	TinyLogic <sup>TM</sup>
CoolFET <sup>TM</sup>	MICROWIRE <sup>TM</sup>	UHC <sup>TM</sup>
CROSSVOLT <sup>TM</sup>	POP <sup>TM</sup>	VCX <sup>TM</sup>
E <sup>2</sup> CMOS <sup>TM</sup>	PowerTrench <sup>®</sup>	
FACT <sup>TM</sup>	QFET <sup>TM</sup>	
FACT Quiet Series <sup>TM</sup>	QS <sup>TM</sup>	
FAST <sup>®</sup>	Quiet Series <sup>TM</sup>	
FAST <sub>r</sub> <sup>TM</sup>	SuperSOT <sup>TM</sup> -3	
GTO <sup>TM</sup>	SuperSOT <sup>TM</sup> -6	
HiSeC <sup>TM</sup>	SuperSOT <sup>TM</sup> -8	

## DISCLAIMER

FAIRCHILD SEMICONDUCTOR RESERVES THE RIGHT TO MAKE CHANGES WITHOUT FURTHER NOTICE TO ANY PRODUCTS HEREIN TO IMPROVE RELIABILITY, FUNCTION OR DESIGN. FAIRCHILD DOES NOT ASSUME ANY LIABILITY ARISING OUT OF THE APPLICATION OR USE OF ANY PRODUCT OR CIRCUIT DESCRIBED HEREIN; NEITHER DOES IT CONVEY ANY LICENSE UNDER ITS PATENT RIGHTS, NOR THE RIGHTS OF OTHERS.

## LIFE SUPPORT POLICY

FAIRCHILD'S PRODUCTS ARE NOT AUTHORIZED FOR USE AS CRITICAL COMPONENTS IN LIFE SUPPORT DEVICES OR SYSTEMS WITHOUT THE EXPRESS WRITTEN APPROVAL OF FAIRCHILD SEMICONDUCTOR CORPORATION. As used herein:

1. Life support devices or systems are devices or systems which, (a) are intended for surgical implant into the body, or (b) support or sustain life, or (c) whose failure to perform when properly used in accordance with instructions for use provided in the labeling, can be reasonably expected to result in significant injury to the user.
2. A critical component is any component of a life support device or system whose failure to perform can be reasonably expected to cause the failure of the life support device or system, or to affect its safety or effectiveness.

## PRODUCT STATUS DEFINITIONS

### Definition of Terms

Datasheet Identification	Product Status	Definition
Advance Information	Formative or In Design	This datasheet contains the design specifications for product development. Specifications may change in any manner without notice.
Preliminary	First Production	This datasheet contains preliminary data, and supplementary data will be published at a later date. Fairchild Semiconductor reserves the right to make changes at any time without notice in order to improve design.
No Identification Needed	Full Production	This datasheet contains final specifications. Fairchild Semiconductor reserves the right to make changes at any time without notice in order to improve design.
Obsolete	Not In Production	This datasheet contains specifications on a product that has been discontinued by Fairchild semiconductor. The datasheet is printed for reference information only.