

NTZD3152P

MOSFET – Dual, P-Channel with ESD Protection, Small Signal, SOT-563

-20 V, -430 mA



ON Semiconductor®

www.onsemi.com

Features

- Low $R_{DS(on)}$ Improving System Efficiency
- Low Threshold Voltage
- ESD Protected Gate
- Small Footprint 1.6 x 1.6 mm
- These Devices are Pb-Free, Halogen Free/BFR Free and are RoHS Compliant

Applications

- Load/Power Switches
- Power Supply Converter Circuits
- Battery Management
- Cell Phones, Digital Cameras, PDAs, Pagers, etc.

MAXIMUM RATINGS ($T_J = 25^\circ\text{C}$ unless otherwise noted.)

Parameter	Symbol	Value	Unit	
Drain-to-Source Voltage	V_{DSS}	-20	V	
Gate-to-Source Voltage	V_{GS}	± 6.0	V	
Continuous Drain Current (Note 1)	Steady State	$T_A = 25^\circ\text{C}$	-430	mA
		$T_A = 85^\circ\text{C}$	-310	
Power Dissipation (Note 1)	Steady State	P_D	250	mW
Continuous Drain Current (Note 1)	$t \leq 5\text{ s}$	$T_A = 25^\circ\text{C}$	-455	mA
		$T_A = 85^\circ\text{C}$	-328	
Power Dissipation (Note 1)	$t \leq 5\text{ s}$	P_D	280	mW
Pulsed Drain Current	$t_p = 10\ \mu\text{s}$	I_{DM}	-750	mA
Operating Junction and Storage Temperature	T_J, T_{STG}	-55 to 150		$^\circ\text{C}$
Source Current (Body Diode)	I_S	-350		mA
Lead Temperature for Soldering Purposes (1/8" from case for 10 s)	T_L	260		$^\circ\text{C}$

THERMAL RESISTANCE RATINGS

Parameter	Symbol	Max	Unit
Junction-to-Ambient – Steady State (Note 1)	$R_{\theta JA}$	500	$^\circ\text{C}/\text{W}$
Junction-to-Ambient – $t \leq 5\text{ s}$ (Note 1)		447	

Stresses exceeding those listed in the Maximum Ratings table may damage the device. If any of these limits are exceeded, device functionality should not be assumed, damage may occur and reliability may be affected.

1. Surface mounted on FR4 board using 1 in. sq. pad size (Cu. area = 1.127 in. sq. [1 oz.] including traces).

$V_{(BR)DSS}$	$R_{DS(on)}$ Typ	I_D Max
-20 V	0.5 Ω @ -4.5 V	-430 mA
	0.6 Ω @ -2.5 V	
	1.0 Ω @ -1.8 V	

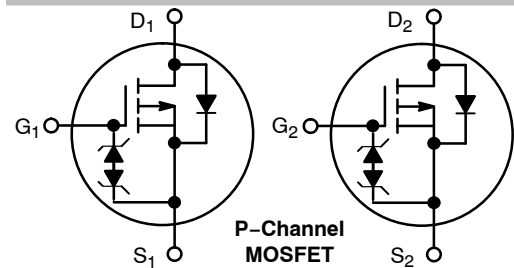

SOT-563-6
CASE 463A

MARKING DIAGRAM

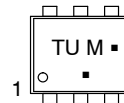

TU = Specific Device Code
M = Date Code
▪ = Pb-Free Package

(Note: Microdot may be in either location)

PINOUT: SOT-563

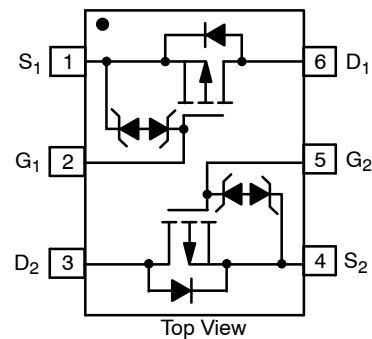

ORDERING INFORMATION

Device	Package	Shipping†
NTZD3152PT1G	SOT-563	4000 / Tape & Reel
NTZD3152PT1H	(Pb-Free)	
NTZD3152PT5H	SOT-563 (Pb-Free)	8000 / Tape & Reel

†For information on tape and reel specifications, including part orientation and tape sizes, please refer to our Tape and Reel Packaging Specifications Brochure, BRD8011/D.

NTZD3152P

ELECTRICAL CHARACTERISTICS ($T_J = 25^\circ\text{C}$ unless otherwise noted.)

Parameter	Symbol	Test Condition	Min	Typ	Max	Unit
OFF CHARACTERISTICS						
Drain-to-Source Breakdown Voltage	$V_{(BR)DSS}$	$V_{GS} = 0\text{ V}, I_D = -250\ \mu\text{A}$	-20			V
Drain-to-Source Breakdown Voltage Temperature Coefficient	$V_{(BR)DSS}/T_J$			18		mV/°C
Zero Gate Voltage Drain Current	I_{DSS}	$V_{GS} = 0\text{ V}, V_{DS} = -16\text{ V}$	$T_J = 25^\circ\text{C}$		-1.0	μA
			$T_J = 125^\circ\text{C}$		-2.0	
Gate-to-Source Leakage Current	I_{GSS}	$V_{DS} = 0\text{ V}, V_{GS} = \pm 4.5\text{ V}$			± 2.0	μA

ON CHARACTERISTICS (Note 2)

Gate Threshold Voltage	$V_{GS(TH)}$	$V_{GS} = V_{DS}, I_D = -250\ \mu\text{A}$	-0.45		-1.0	V
Negative Threshold Temperature Coefficient	$V_{GS(TH)}/T_J$			-1.9		mV/°C
Drain-to-Source On Resistance	$R_{DS(on)}$	$V_{GS} = -4.5\text{ V}, I_D = -430\text{ mA}$		0.5	0.9	Ω
		$V_{GS} = -2.5\text{ V}, I_D = -300\text{ mA}$		0.6	1.2	
		$V_{GS} = -1.8\text{ V}, I_D = -150\text{ mA}$		1.0	2.0	
Forward Transconductance	g_{FS}	$V_{DS} = -10\text{ V}, I_D = -430\text{ mA}$		1.0		S

CHARGES AND CAPACITANCES

Input Capacitance	C_{ISS}	$V_{GS} = 0\text{ V}, f = 1.0\text{ MHz}, V_{DS} = -16\text{ V}$		105	175	pF
Output Capacitance	C_{OSS}			15	30	
Reverse Transfer Capacitance	C_{RSS}			10	20	
Total Gate Charge	$Q_{G(TOT)}$	$V_{GS} = -4.5\text{ V}, V_{DS} = -10\text{ V}, I_D = -215\text{ mA}$		1.7	2.5	nC
Threshold Gate Charge	$Q_{G(TH)}$			0.1		
Gate-to-Source Charge	Q_{GS}			0.3		
Gate-to-Drain Charge	Q_{GD}			0.4		

SWITCHING CHARACTERISTICS (Note 3)

Turn-On Delay Time	$t_{d(on)}$	$V_{GS} = -4.5\text{ V}, V_{DD} = -10\text{ V}, I_D = -215\text{ mA}, R_G = 10\ \Omega$		10		ns
Rise Time	t_r			12		
Turn-Off Delay Time	$t_{d(off)}$			35		
Fall Time	t_f			19		

DRAIN-SOURCE DIODE CHARACTERISTICS

Forward Diode Voltage	V_{SD}	$V_{GS} = 0\text{ V}, I_S = -350\text{ mA}$	$T_J = 25^\circ\text{C}$		-0.8	-1.2	V
Reverse Recovery Time	t_{RR}	$V_{GS} = 0\text{ V}, di_{SD}/dt = 100\text{ A}/\mu\text{s}, I_S = -350\text{ mA}$			13		ns

Product parametric performance is indicated in the Electrical Characteristics for the listed test conditions, unless otherwise noted. Product performance may not be indicated by the Electrical Characteristics if operated under different conditions.

2. Pulse Test: pulse width $\leq 300\ \mu\text{s}$, duty cycle $\leq 2\%$.
3. Switching characteristics are independent of operating junction temperatures.

NTZD3152P

TYPICAL PERFORMANCE CURVES ($T_J = 25^\circ\text{C}$ unless otherwise noted)

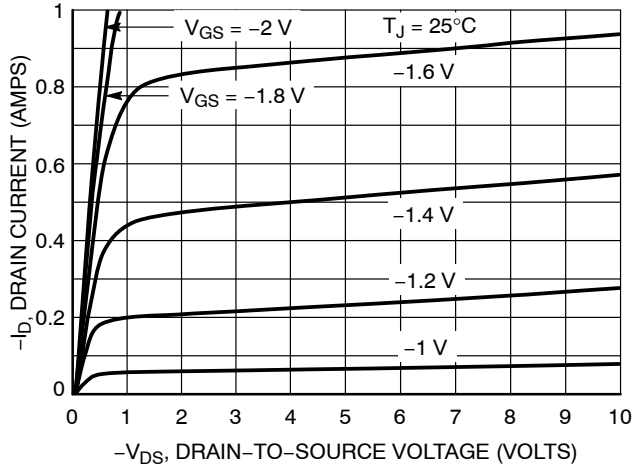

Figure 1. On-Region Characteristics

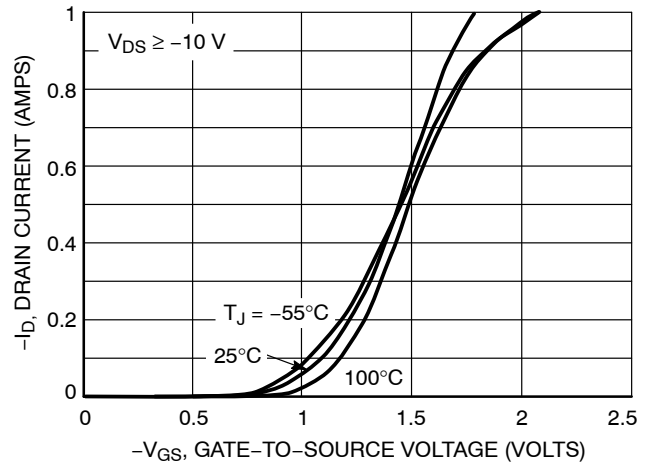

Figure 2. Transfer Characteristics

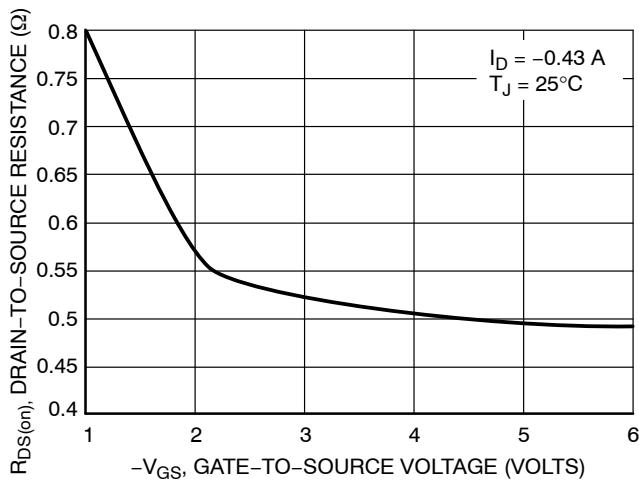

Figure 3. On-Resistance vs. Gate-to-Source Voltage

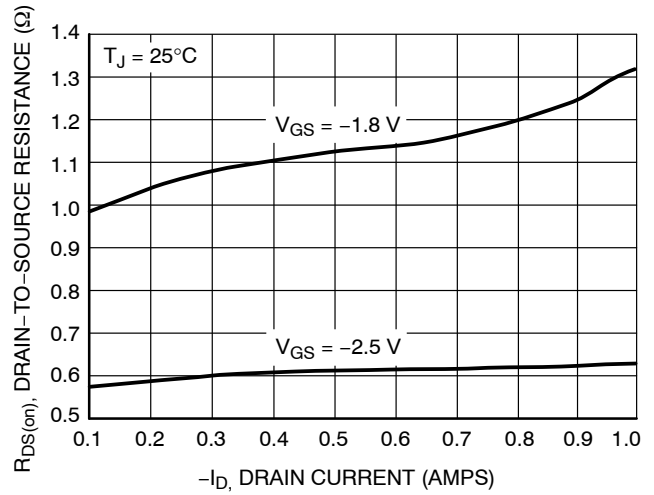

Figure 4. On-Resistance vs. Drain Current and Gate Voltage

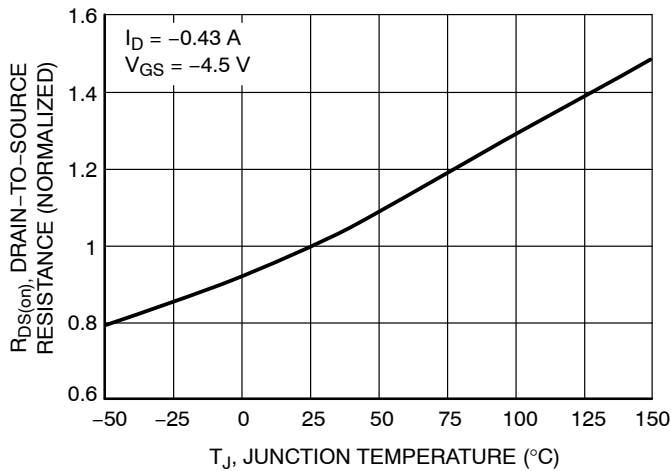

Figure 5. On-Resistance Variation with Temperature

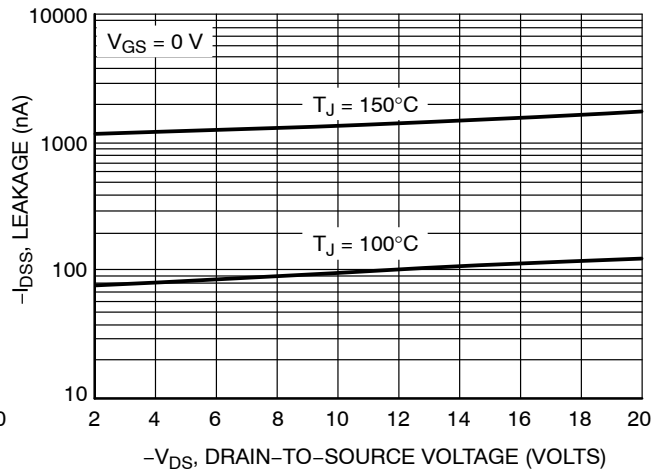

Figure 6. Drain-to-Source Leakage Current vs. Voltage

NTZD3152P

TYPICAL PERFORMANCE CURVES ($T_J = 25^\circ\text{C}$ unless otherwise noted)

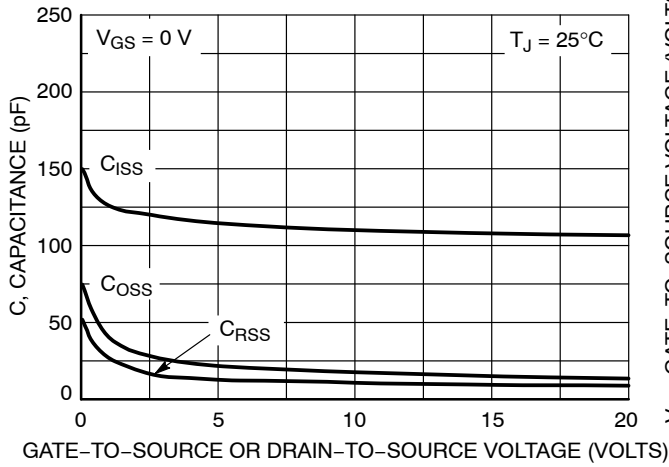

Figure 7. Capacitance Variation

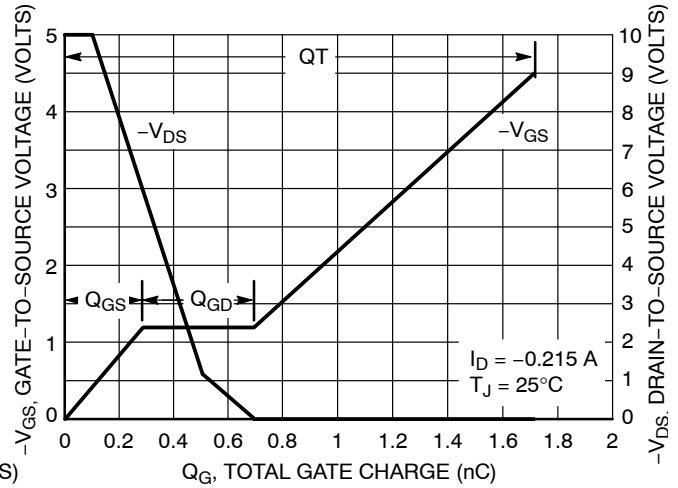

Figure 8. Gate-to-Source and Drain-to-Source Voltage vs. Total Charge

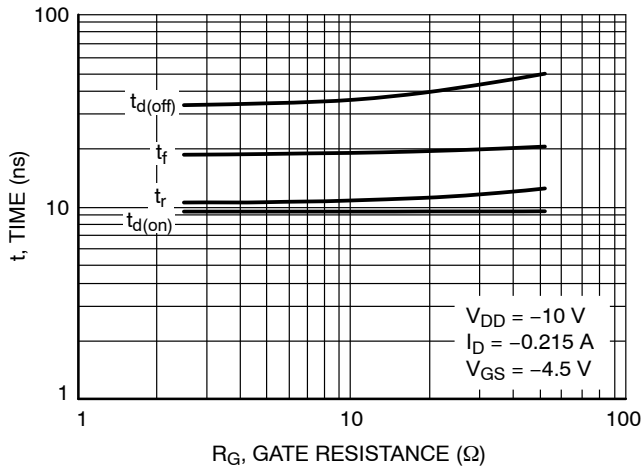

Figure 9. Resistive Switching Time Variation vs. Gate Resistance

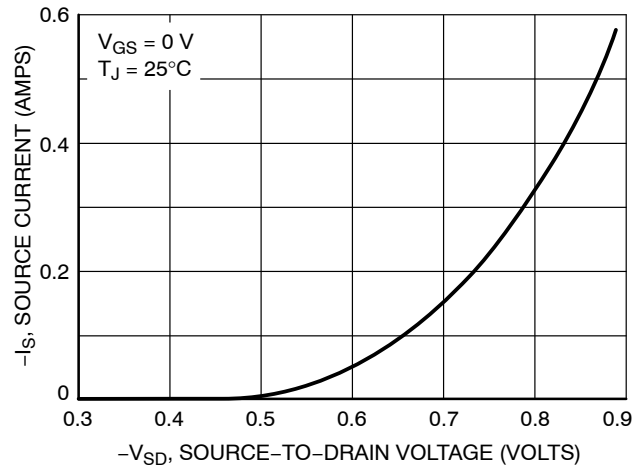

Figure 10. Diode Forward Voltage vs. Current

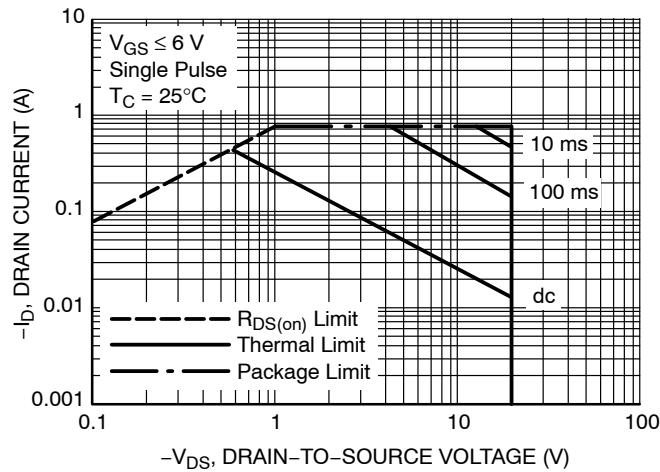
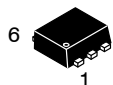

Figure 11. Safe Operating Area

MECHANICAL CASE OUTLINE

PACKAGE DIMENSIONS

ON Semiconductor®



SCALE 4:1

SOT-563, 6 LEAD
CASE 463A
ISSUE H

DATE 26 JAN 2021

NOTES:

1. DIMENSIONING AND TOLERANCING PER ASME Y14.5M, 2009.
2. CONTROLLING DIMENSION: MILLIMETERS
3. MAXIMUM LEAD THICKNESS INCLUDES LEAD FINISH THICKNESS. MINIMUM LEAD THICKNESS IS THE MINIMUM THICKNESS OF BASE MATERIAL.



DIM	MILLIMETERS		
	MIN.	NOM.	MAX.
A	0.50	0.55	0.60
b	0.17	0.22	0.27
c	0.08	0.13	0.18
D	1.50	1.60	1.70
E	1.10	1.20	1.30
e	0.50 BSC		
L	0.10	0.20	0.30
H _E	1.50	1.60	1.70

RECOMMENDED MOUNTING FOOTPRINT*

* For additional information on our Pb-Free strategy and soldering details, please download the ON Semiconductor Soldering and Mounting Techniques Reference Manual, SOLDERRM/D.

DOCUMENT NUMBER:	98AON11126D	Electronic versions are uncontrolled except when accessed directly from the Document Repository. Printed versions are uncontrolled except when stamped "CONTROLLED COPY" in red.
DESCRIPTION:	SOT-563, 6 LEAD	PAGE 1 OF 2

ON Semiconductor and are trademarks of Semiconductor Components Industries, LLC dba ON Semiconductor or its subsidiaries in the United States and/or other countries. ON Semiconductor reserves the right to make changes without further notice to any products herein. ON Semiconductor makes no warranty, representation or guarantee regarding the suitability of its products for any particular purpose, nor does ON Semiconductor assume any liability arising out of the application or use of any product or circuit, and specifically disclaims any and all liability, including without limitation special, consequential or incidental damages. ON Semiconductor does not convey any license under its patent rights nor the rights of others.

SOT-563, 6 LEAD
CASE 463A
ISSUE H

DATE 26 JAN 2021

STYLE 1: PIN 1. EMITTER 1 2. BASE 1 3. COLLECTOR 2 4. EMITTER 2 5. BASE 2 6. COLLECTOR 1	STYLE 2: PIN 1. EMITTER 1 2. EMITTER 2 3. BASE 2 4. COLLECTOR 2 5. BASE 1 6. COLLECTOR 1	STYLE 3: PIN 1. CATHODE 1 2. CATHODE 1 3. ANODE/ANODE 2 4. CATHODE 2 5. CATHODE 2 6. ANODE/ANODE 1
--	--	--

STYLE 4: PIN 1. COLLECTOR 2. COLLECTOR 3. BASE 4. EMITTER 5. COLLECTOR 6. COLLECTOR	STYLE 5: PIN 1. CATHODE 2. CATHODE 3. ANODE 4. ANODE 5. CATHODE 6. CATHODE	STYLE 6: PIN 1. CATHODE 2. ANODE 3. CATHODE 4. CATHODE 5. CATHODE 6. CATHODE
---	--	--

STYLE 7: PIN 1. CATHODE 2. ANODE 3. CATHODE 4. CATHODE 5. ANODE 6. CATHODE	STYLE 8: PIN 1. DRAIN 2. DRAIN 3. GATE 4. SOURCE 5. DRAIN 6. DRAIN	STYLE 9: PIN 1. SOURCE 1 2. GATE 1 3. DRAIN 2 4. SOURCE 2 5. GATE 2 6. DRAIN 1
--	--	--

STYLE 10: PIN 1. CATHODE 1 2. N/C 3. CATHODE 2 4. ANODE 2 5. N/C 6. ANODE 1	STYLE 11: PIN 1. EMITTER 2 2. BASE 2 3. COLLECTOR 1 4. EMITTER 1 5. BASE 1 6. COLLECTOR 2
---	---

**GENERIC
MARKING DIAGRAM***

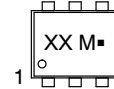

XX = Specific Device Code
M = Month Code
■ = Pb-Free Package

*This information is generic. Please refer to device data sheet for actual part marking. Pb-Free indicator, "G" or microdot "■", may or may not be present. Some products may not follow the Generic Marking.

DOCUMENT NUMBER:	98AON11126D	Electronic versions are uncontrolled except when accessed directly from the Document Repository. Printed versions are uncontrolled except when stamped "CONTROLLED COPY" in red.
DESCRIPTION:	SOT-563, 6 LEAD	PAGE 2 OF 2

ON Semiconductor and are trademarks of Semiconductor Components Industries, LLC dba ON Semiconductor or its subsidiaries in the United States and/or other countries. ON Semiconductor reserves the right to make changes without further notice to any products herein. ON Semiconductor makes no warranty, representation or guarantee regarding the suitability of its products for any particular purpose, nor does ON Semiconductor assume any liability arising out of the application or use of any product or circuit, and specifically disclaims any and all liability, including without limitation special, consequential or incidental damages. ON Semiconductor does not convey any license under its patent rights nor the rights of others.

onsemi, **Onsemi**, and other names, marks, and brands are registered and/or common law trademarks of Semiconductor Components Industries, LLC dba "**onsemi**" or its affiliates and/or subsidiaries in the United States and/or other countries. **onsemi** owns the rights to a number of patents, trademarks, copyrights, trade secrets, and other intellectual property. A listing of **onsemi**'s product/patent coverage may be accessed at www.onsemi.com/site/pdf/Patent-Marking.pdf. **onsemi** reserves the right to make changes at any time to any products or information herein, without notice. The information herein is provided "as-is" and **onsemi** makes no warranty, representation or guarantee regarding the accuracy of the information, product features, availability, functionality, or suitability of its products for any particular purpose, nor does **onsemi** assume any liability arising out of the application or use of any product or circuit, and specifically disclaims any and all liability, including without limitation special, consequential or incidental damages. Buyer is responsible for its products and applications using **onsemi** products, including compliance with all laws, regulations and safety requirements or standards, regardless of any support or applications information provided by **onsemi**. "Typical" parameters which may be provided in **onsemi** data sheets and/or specifications can and do vary in different applications and actual performance may vary over time. All operating parameters, including "Typicals" must be validated for each customer application by customer's technical experts. **onsemi** does not convey any license under any of its intellectual property rights nor the rights of others. **onsemi** products are not designed, intended, or authorized for use as a critical component in life support systems or any FDA Class 3 medical devices or medical devices with a same or similar classification in a foreign jurisdiction or any devices intended for implantation in the human body. Should Buyer purchase or use **onsemi** products for any such unintended or unauthorized application, Buyer shall indemnify and hold **onsemi** and its officers, employees, subsidiaries, affiliates, and distributors harmless against all claims, costs, damages, and expenses, and reasonable attorney fees arising out of, directly or indirectly, any claim of personal injury or death associated with such unintended or unauthorized use, even if such claim alleges that **onsemi** was negligent regarding the design or manufacture of the part. **onsemi** is an Equal Opportunity/Affirmative Action Employer. This literature is subject to all applicable copyright laws and is not for resale in any manner.

PUBLICATION ORDERING INFORMATION

LITERATURE FULFILLMENT:

Email Requests to: orderlit@onsemi.com

onsemi Website: www.onsemi.com

TECHNICAL SUPPORT

North American Technical Support:

Voice Mail: 1 800-282-9855 Toll Free USA/Canada

Phone: 011 421 33 790 2910

Europe, Middle East and Africa Technical Support:

Phone: 00421 33 790 2910

For additional information, please contact your local Sales Representative

