

IRLML9303TRPbF

HEXFET® Power MOSFET

V_{DS}	-30	V
V_{GS Max}	± 20	V
R_{DS(on) max} (@V _{GS} = -10V)	165	mΩ
R_{DS(on) max} (@V _{GS} = -4.5V)	270	mΩ

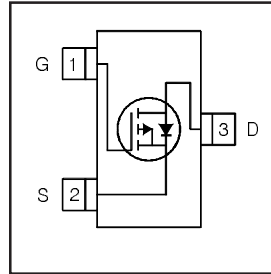

Application(s)

- System/Load Switch

Features and Benefits

Features

Industry-standard pinout
Compatible with existing Surface Mount Techniques
RoHS compliant containing no lead, no bromide and no halogen
MSL1, Consumer qualification

results in

⇒

Benefits

Multi-vendor compatibility
Easier manufacturing
Environmentally friendly
Increased reliability

Absolute Maximum Ratings

Symbol	Parameter	Max.	Units
V _{DS}	Drain-Source Voltage	-30	V
I _D @ T _A = 25°C	Continuous Drain Current, V _{GS} @ 10V	-2.3	A
I _D @ T _A = 70°C	Continuous Drain Current, V _{GS} @ 10V	-1.8	
I _{DM}	Pulsed Drain Current	-12	
P _D @ T _A = 25°C	Maximum Power Dissipation	1.25	W
P _D @ T _A = 70°C	Maximum Power Dissipation	0.80	
	Linear Derating Factor	0.01	W/°C
V _{GS}	Gate-to-Source Voltage	± 20	V
T _J , T _{STG}	Junction and Storage Temperature Range	-55 to + 150	°C

Thermal Resistance

Symbol	Parameter	Typ.	Max.	Units
R _{θJA}	Junction-to-Ambient ③	—	100	°C/W
R _{θJA}	Junction-to-Ambient (t<10s) ④	—	99	

ORDERING INFORMATION:

See detailed ordering and shipping information on the last page of this data sheet.

Notes ① through ④ are on page 10
www.irf.com

IRLML9303TRPbF

International
IR Rectifier

Electric Characteristics @ $T_J = 25^\circ\text{C}$ (unless otherwise specified)

Symbol	Parameter	Min.	Typ.	Max.	Units	Conditions
$V_{(BR)DSS}$	Drain-to-Source Breakdown Voltage	-30	—	—	V	$V_{GS} = 0V, I_D = -250\mu A$
$\Delta V_{(BR)DSS}/\Delta T_J$	Breakdown Voltage Temp. Coefficient	—	-3.7	—	mV/°C	Reference to $25^\circ\text{C}, I_D = -1\text{mA}$
$R_{DS(on)}$	Static Drain-to-Source On-Resistance	—	135	165	mΩ	$V_{GS} = -10V, I_D = -2.3A$ ②
		—	220	270		$V_{GS} = -4.5V, I_D = -1.8A$ ②
$V_{GS(th)}$	Gate Threshold Voltage	-1.3	—	-2.4	V	$V_{DS} = V_{GS}, I_D = -10\mu A$
I_{DSS}	Drain-to-Source Leakage Current	—	—	1.0	μA	$V_{DS} = -24V, V_{GS} = 0V$
		—	—	150		$V_{DS} = -24V, V_{GS} = 0V, T_J = 125^\circ\text{C}$
I_{GSS}	Gate-to-Source Forward Leakage	—	—	-100	nA	$V_{GS} = -20V$
	Gate-to-Source Reverse Leakage	—	—	100		$V_{GS} = 20V$
R_G	Internal Gate Resistance	—	21	—	Ω	
g_{fs}	Forward Transconductance	2.3	—	—	S	$V_{DS} = -10V, I_D = -2.3A$
Q_g	Total Gate Charge	—	2.0	—	nC	$I_D = -2.3A$
Q_{gs}	Gate-to-Source Charge	—	0.57	—		$V_{DS} = -15V$
Q_{gd}	Gate-to-Drain ("Miller") Charge	—	1.2	—		$V_{GS} = -4.5V$ ②
$t_{d(on)}$	Turn-On Delay Time	—	7.5	—	ns	$V_{DD} = -15V$ ②
t_r	Rise Time	—	14	—		$I_D = -1.0A$
$t_{d(off)}$	Turn-Off Delay Time	—	9.0	—		$R_G = 6.8\Omega$
t_f	Fall Time	—	8.6	—		$V_{GS} = -4.5V$
C_{iss}	Input Capacitance	—	160	—	pF	$V_{GS} = 0V$
C_{oss}	Output Capacitance	—	39	—		$V_{DS} = -25V$
C_{rss}	Reverse Transfer Capacitance	—	25	—		$f = 1.0\text{KHz}$

Source - Drain Ratings and Characteristics

Symbol	Parameter	Min.	Typ.	Max.	Units	Conditions
I_S	Continuous Source Current (Body Diode)	—	—	-1.3	A	MOSFET symbol showing the integral reverse p-n junction diode.
I_{SM}	Pulsed Source Current (Body Diode) ①	—	—	-12		
V_{SD}	Diode Forward Voltage	—	—	-1.2	V	$T_J = 25^\circ\text{C}, I_S = -1.3A, V_{GS} = 0V$ ②
t_{rr}	Reverse Recovery Time	—	12	18	ns	$T_J = 25^\circ\text{C}, V_R = -24V, I_F = -1.3A$
Q_{rr}	Reverse Recovery Charge	—	5.3	8.0	nC	$di/dt = 100A/\mu s$ ②

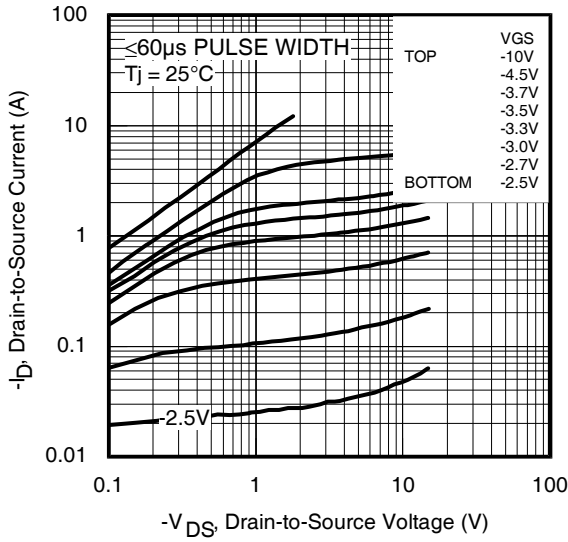

Fig 1. Typical Output Characteristics

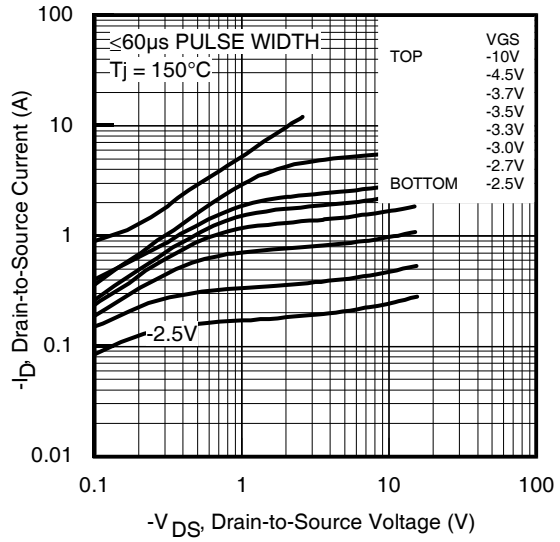

Fig 2. Typical Output Characteristics

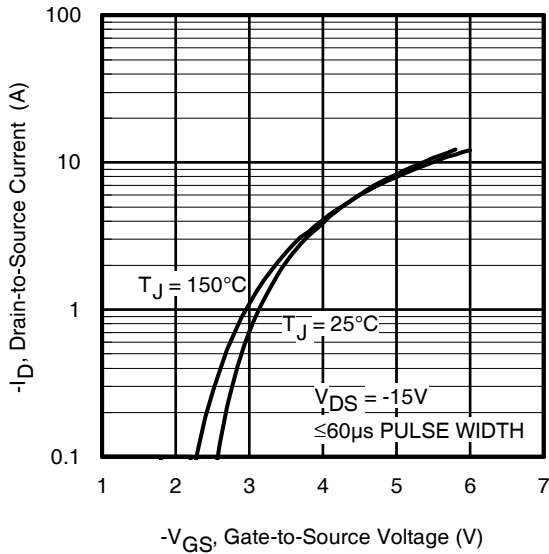

Fig 3. Typical Transfer Characteristics

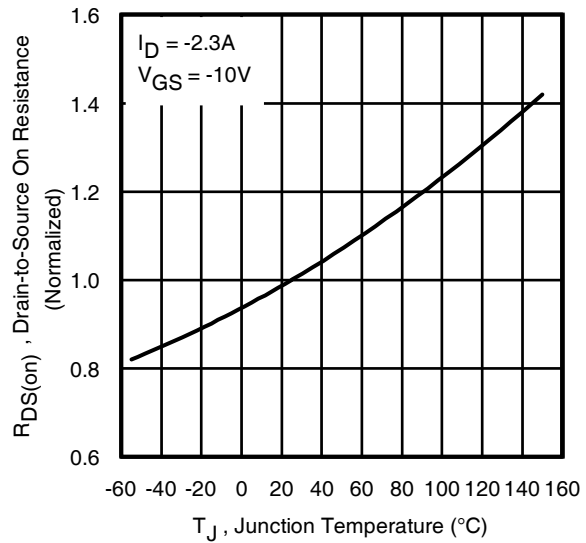

Fig 4. Normalized On-Resistance vs. Temperature

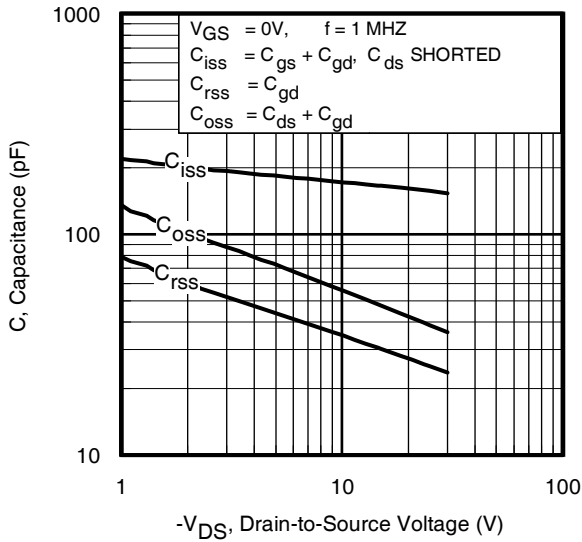

Fig 5. Typical Capacitance vs. Drain-to-Source Voltage

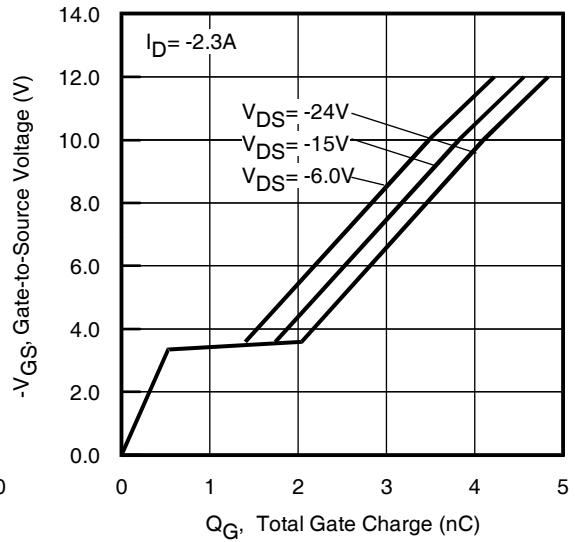

Fig 6. Typical Gate Charge vs. Gate-to-Source Voltage

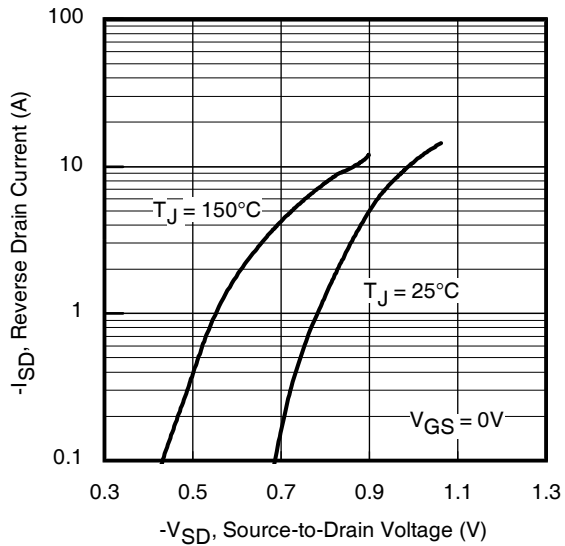

Fig 7. Typical Source-Drain Diode Forward Voltage

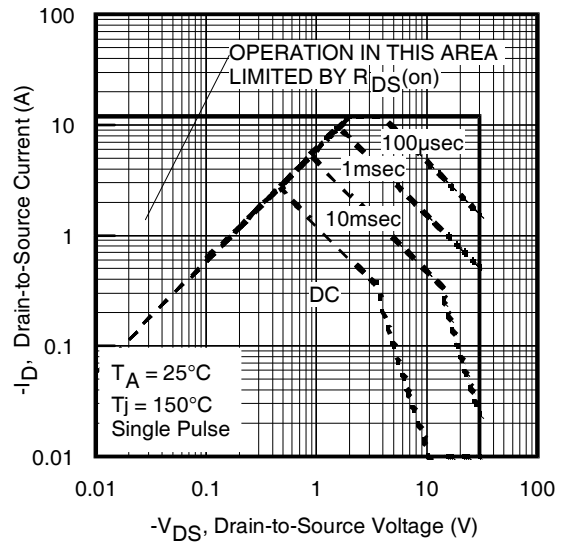

Fig 8. Maximum Safe Operating Area

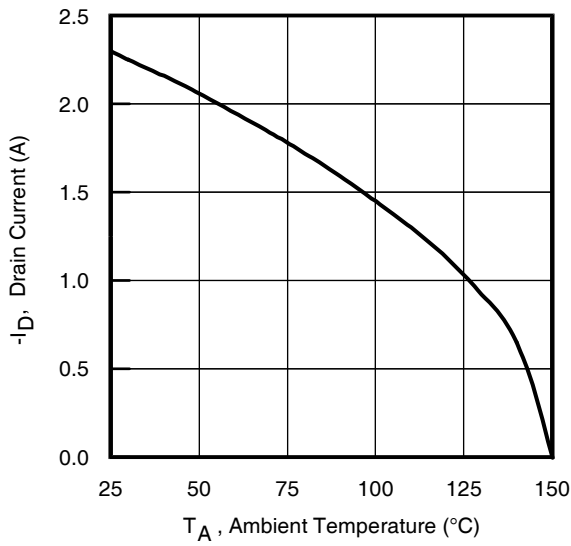

Fig 9. Maximum Drain Current vs. Ambient Temperature

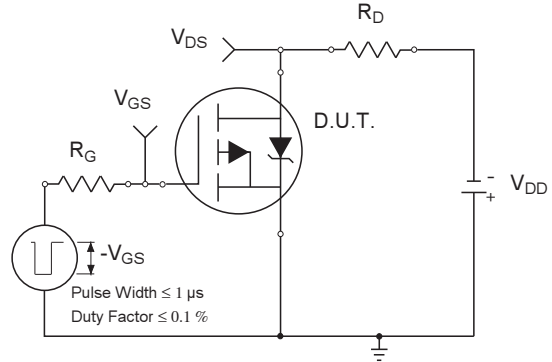

Fig 10a. Switching Time Test Circuit

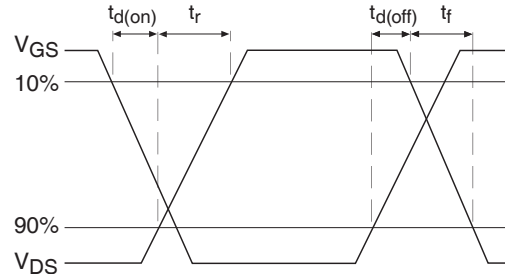

Fig 10b. Switching Time Waveforms

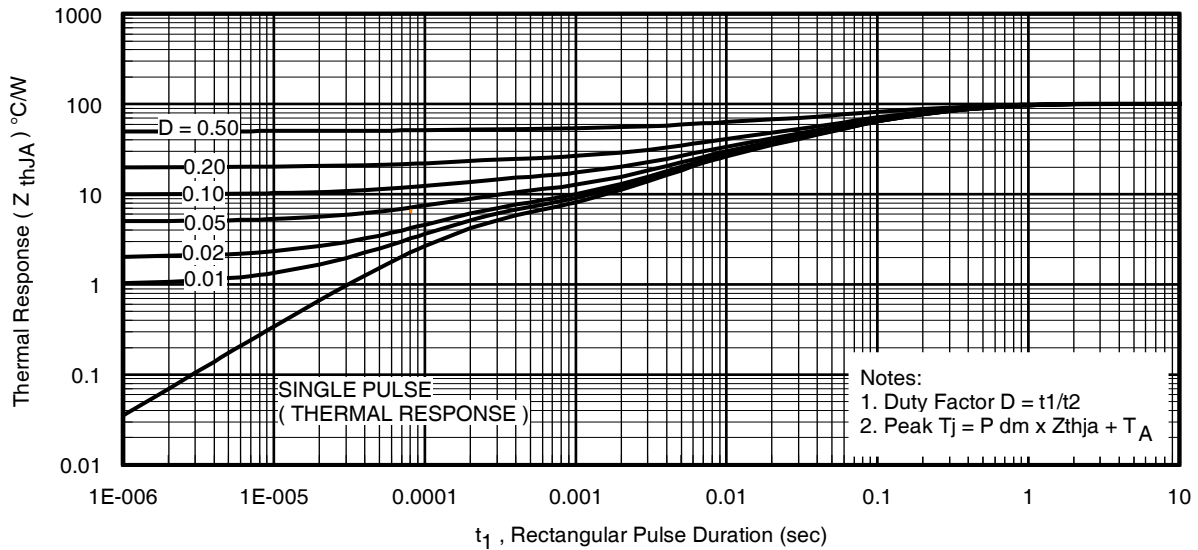

Fig 11. Typical Effective Transient Thermal Impedance, Junction-to-Ambient

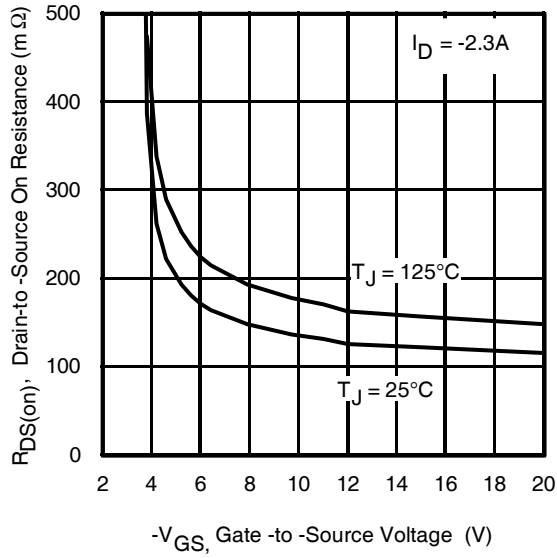

Fig 12. Typical On-Resistance vs. Gate Voltage

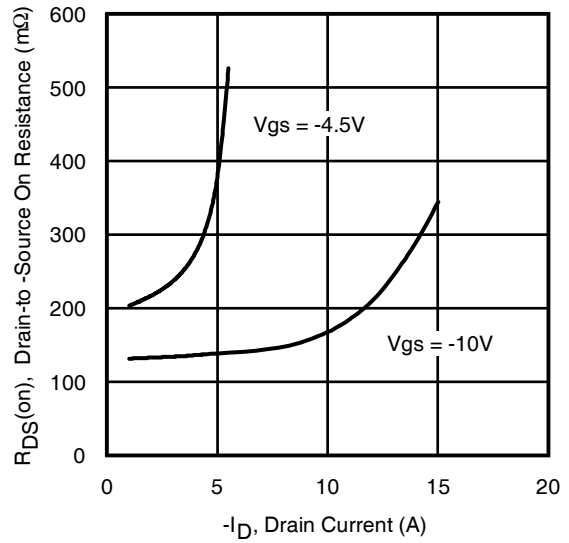

Fig 13. Typical On-Resistance vs. Drain Current

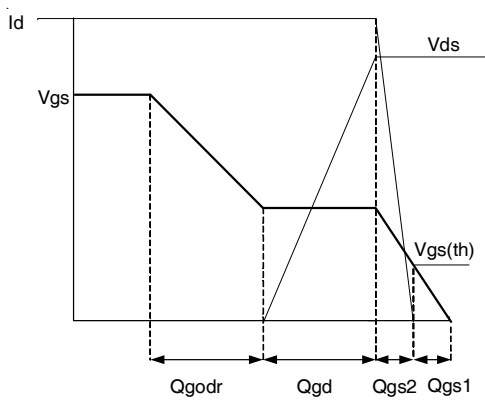

Fig 14a. Gate Charge Waveform

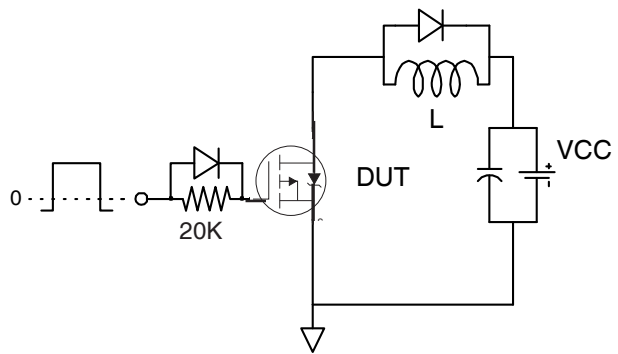

Fig 14b. Gate Charge Test Circuit

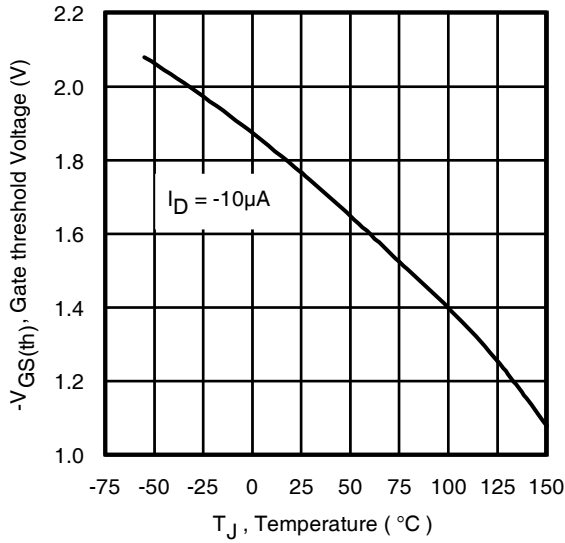

Fig 15. Typical Threshold Voltage vs. Junction Temperature

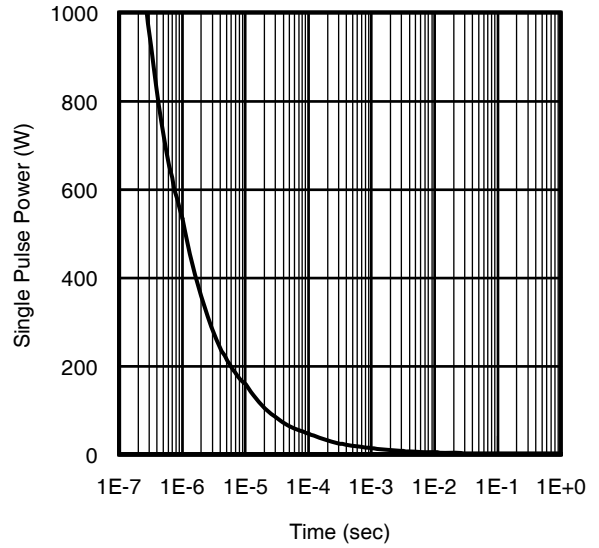

Fig 16. Typical Power vs. Time

IRLML9303TRPbF

International
IR Rectifier

Micro3 (SOT-23) Package Outline

Dimensions are shown in millimeters (inches)

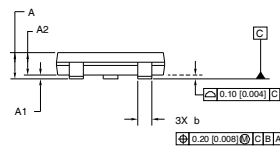
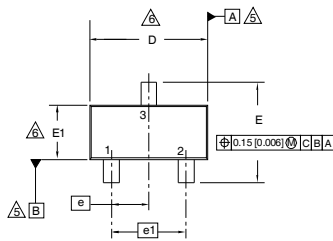

NOTES:

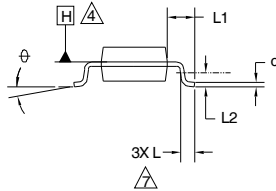

Recommended Footprint

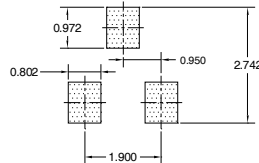

SYMBOL	MILLIMETERS		INCHES	
	MIN	MAX	MIN	MAX
A	0.89	1.12	0.035	0.044
A1	0.01	0.10	0.0004	0.004
A2	0.88	1.02	0.035	0.040
b	0.30	0.50	0.012	0.020
c	0.08	0.20	0.003	0.008
D	2.80	3.04	0.110	0.120
E	2.10	2.64	0.083	0.104
E1	1.20	1.40	0.047	0.055
e	0.95	BSC	0.037	BSC
e1	1.90	BSC	0.075	BSC
L	0.40	0.60	0.016	0.024
L1	0.54	REF	0.021	REF
L2	0.25	BSC	0.010	BSC
∅	0	8	0	8

1. DIMENSIONING & TOLERANCING PER ANSI Y14.5M-1994
2. DIMENSIONS ARE SHOWN IN MILLIMETERS (INCHES)
3. CONTROLLING DIMENSION: MILLIMETER
4. DATUM PLANE H IS LOCATED AT THE MOLD PARTING LINE
5. DATUM A AND B TO BE DETERMINED AT DATUM PLANE H
6. DIMENSIONS D AND E1 ARE MEASURED AT DATUM PLANE H. DIMENSIONS DOES NOT INCLUDE MOLD PROTRUSIONS OR INTERLEAD FLASH. MOLD PROTRUSIONS OR INTERLEAD FLASH SHALL NOT EXCEED 0.25 MM [0.010 INCH] PER SIDE
7. DIMENSION L IS THE LEAD LENGTH FOR SOLDERING TO A SUBSTRATE
8. OUTLINE CONFORMS TO JEDEC OUTLINE TO-236 AB.

Micro3 (SOT-23/TO-236AB) Part Marking Information

Notes: This part marking information applies to devices produced after 02/26/2001

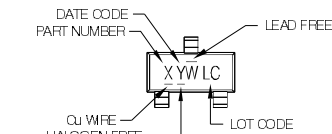

X = PART NUMBER CODE REFERENCE:

A = IRLML2402	S = IRLML6244
B = IRLML2803	T = IRLML6246
C = IRLML6302	U = IRLML6344
D = IRLML5103	V = IRLML6346
E = IRLML6402	W = IRLML6244
F = IRLML6401	X = IRLML2244
G = IRLML2502	Y = IRLML2246
H = IRLML5203	Z = IRLML9244
I = IRLML0030	
J = IRLML2030	
K = IRLML0100	
L = IRLML0060	
M = IRLML0040	
N = IRLML2060	
P = IRLML9301	
R = IRLML9303	

Note: A line above the work week (as shown here) indicates Lead - Free.

DATE CODE MARKING INSTRUCTIONS

WW = (1-26) IF PRECEDED BY LAST DIGIT OF CALENDAR YEAR

YEAR	Y	WORK WEEK	W
2011	2001	1	01
2012	2002	2	02
2013	2003	3	03
2014	2004	4	04
2015	2005	5	
2016	2006	6	
2017	2007	7	
2018	2008	8	
2019	2009	9	
2020	2010	0	24
			25
			26

WW = (27-52) IF PRECEDED BY A LETTER

YEAR	Y	WORK WEEK	W
2011	2001	A	27
2012	2002	B	28
2013	2003	C	29
2014	2004	D	30
2015	2005	E	
2016	2006	F	
2017	2007	G	
2018	2008	H	
2019	2009	J	
2020	2010	K	50
			51
			52

Note: For the most current drawing please refer to IR website at: <http://www.irf.com/package/>

Micro3™ Tape & Reel Information

Dimensions are shown in millimeters (inches)

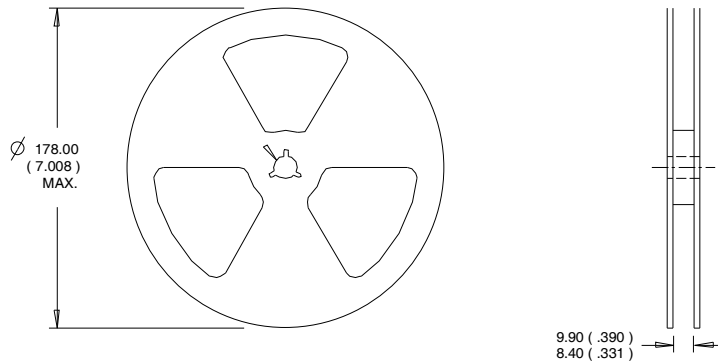
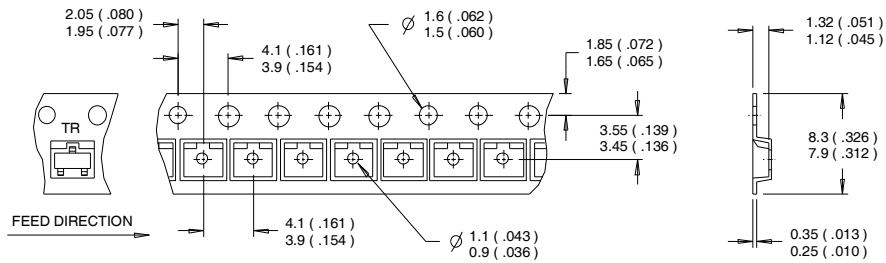

- NOTES:
 1. CONTROLLING DIMENSION : MILLIMETER.
 2. OUTLINE CONFORMS TO EIA-481 & EIA-541.

Note: For the most current drawing please refer to IR website at: <http://www.irf.com/package/>
www.irf.com

IRLML9303TRPbF

International
IOR Rectifier

Orderable part number	Package Type	Standard Pack		Note
		Form	Quantity	
IRLML9303TRPbF	Micro3 (SOT-23)	Tape and Reel	3000	

Qualification information[†]

Qualification level	Consumer ^{††} (per JEDEC JESD47F ^{†††} guidelines)	
Moisture Sensitivity Level	Micro3 (SOT-23)	MSL1 (per IPC/JEDEC J-STD-020D ^{†††})
RoHS compliant	Yes	

- † Qualification standards can be found at International Rectifier's web site
<http://www.irf.com/product-info/reliability>
- †† Higher qualification ratings may be available should the user have such requirements.
Please contact your International Rectifier sales representative for further information:
<http://www.irf.com/whoto-call/salesrep/>
- ††† Applicable version of JEDEC standard at the time of product release.

Notes:

- ① Repetitive rating; pulse width limited by max. junction temperature.
- ② Pulse width $\leq 400\mu\text{s}$; duty cycle $\leq 2\%$.
- ③ Surface mounted on 1 in square Cu board.
- ④ Refer to [application note #AN-994](#).

Data and specifications subject to change without notice.

International
IOR Rectifier

IR WORLD HEADQUARTERS: 101 N. Sepulveda Blvd., El Segundo, California 90245, USA Tel: (310) 252-7105
TAC Fax: (310) 252-7903

Visit us at www.irf.com for sales contact information.03/12

IMPORTANT NOTICE

The information given in this document shall in no event be regarded as a guarantee of conditions or characteristics ("Beschaffheitsgarantie").

With respect to any examples, hints or any typical values stated herein and/or any information regarding the application of the product, Infineon Technologies hereby disclaims any and all warranties and liabilities of any kind, including without limitation warranties of non-infringement of intellectual property rights of any third party.

In addition, any information given in this document is subject to customer's compliance with its obligations stated in this document and any applicable legal requirements, norms and standards concerning customer's products and any use of the product of Infineon Technologies in customer's applications.

The data contained in this document is exclusively intended for technically trained staff. It is the responsibility of customer's technical departments to evaluate the suitability of the product for the intended application and the completeness of the product information given in this document with respect to such application.

For further information on the product, technology, delivery terms and conditions and prices please contact your nearest Infineon Technologies office (www.infineon.com).

WARNINGS

Due to technical requirements products may contain dangerous substances. For information on the types in question please contact your nearest Infineon Technologies office.

Except as otherwise explicitly approved by Infineon Technologies in a written document signed by authorized representatives of Infineon Technologies, Infineon Technologies' products may not be used in any applications where a failure of the product or any consequences of the use thereof can reasonably be expected to result in personal injury.