

## Fast Rectifier Surface-Mount

### eSMP® Series

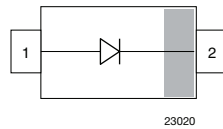
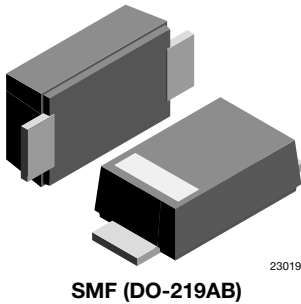

### FEATURES

- For surface mounted applications
- Low profile package
- Ideal for automated placement
- Glass passivated
- Meets MSL level 1, per J-STD-020, LF maximum peak of 260 °C
- Meets JESD 201 class 2 whisker test
- Wave and reflow solderable
- AEC-Q101 qualified
- Compatible to SOD-123W package case outline or SOD-123F and SOD-123FL
- Material categorization: for definitions of compliance please see [www.vishay.com/doc?99912](http://www.vishay.com/doc?99912)

**RoHS**  
COMPLIANT

### LINKS TO ADDITIONAL RESOURCES



### MECHANICAL DATA

**Case:** SMF (DO-219AB)

**Polarity:** band denotes cathode end

**Weight:** approx. 15 mg

**Packaging codes / options:**

GS18/10K per 13" reel (8 mm tape)

GS08/3K per 7" reel (8 mm tape)

**Circuit configuration:** single

### PARTS TABLE

PART	ORDERING CODE	MARKING	REMARKS
RS07B	RS07B-GS18 or RS07B-GS08	RB	Tape and reel
RS07D	RS07D-GS18 or RS07D-GS08	RD	Tape and reel
RS07G	RS07G-GS18 or RS07G-GS08	RG	Tape and reel
RS07J	RS07J-GS18 or RS07J-GS08	RJ	Tape and reel
RS07K	RS07K-GS18 or RS07K-GS08	RK	Tape and reel

### ABSOLUTE MAXIMUM RATINGS ( $T_{amb} = 25\text{ °C}$ , unless otherwise specified)

PARAMETER	TEST CONDITION	PART	SYMBOL	VALUE	UNIT
Maximum repetitive peak reverse voltage		RS07B	$V_{RRM}$	100	V
		RS07D	$V_{RRM}$	200	V
		RS07G	$V_{RRM}$	400	V
		RS07J	$V_{RRM}$	600	V
		RS07K	$V_{RRM}$	800	V
Maximum RMS voltage		RS07B	$V_{RMS}$	70	V
		RS07D	$V_{RMS}$	140	V
		RS07G	$V_{RMS}$	280	V
		RS07J	$V_{RMS}$	420	V
		RS07K	$V_{RMS}$	560	V
Maximum DC blocking voltage		RS07B	$V_{DC}$	100	V
		RS07D	$V_{DC}$	200	V
		RS07G	$V_{DC}$	400	V
		RS07J	$V_{DC}$	600	V
		RS07K	$V_{DC}$	800	V
Maximum average forward rectified current	$T_L = 65\text{ °C}$		$I_{F(AV)}$	1.4	A
	$T_A = 45\text{ °C}$		$I_{F(AV)}$	0.5	A
Peak forward surge current 8.3 ms half sine-wave	$T_L = 25\text{ °C}$		$I_{FSM}$	30	A



THERMAL CHARACTERISTICS (T <sub>amb</sub> = 25 °C, unless otherwise specified)				
PARAMETER	TEST CONDITION	SYMBOL	VALUE	UNIT
Thermal resistance junction to lead		R <sub>thJL</sub>	30	K/W
Thermal resistance junction to ambient air <sup>(1)</sup>		R <sub>thJA</sub>	180	K/W
Operating junction and storage temperature range		T <sub>j</sub> , T <sub>stg</sub>	-55 to 150	°C

**Note**

<sup>(1)</sup> Mounted on epoxy glass PCB with 3 mm x 3 mm Cu pads (≥ 40 μm thick)

ELECTRICAL CHARACTERISTICS (T <sub>amb</sub> = 25 °C, unless otherwise specified)							
PARAMETER	TEST CONDITION	PART	SYMBOL	MIN.	TYP.	MAX.	UNIT
Instantaneous forward voltage	I <sub>F</sub> = 0.7 A <sup>(1)</sup>	RS07B	V <sub>F</sub>			1.15	V
		RS07D	V <sub>F</sub>			1.15	V
		RS07G	V <sub>F</sub>			1.15	V
		RS07J	V <sub>F</sub>			1.15	V
		RS07K	V <sub>F</sub>			1.3	V
		I <sub>F</sub> = 1 A <sup>(1)</sup>					
Maximum DC reverse current at rated DC blocking voltage	T <sub>A</sub> = 25 °C	RS07B	I <sub>R</sub>			10	μA
		RS07D	I <sub>R</sub>			10	μA
		RS07G	I <sub>R</sub>			10	μA
		RS07J	I <sub>R</sub>			10	μA
		RS07K	I <sub>R</sub>			2	μA
		RS07B	I <sub>R</sub>			50	μA
	T <sub>A</sub> = 125 °C	RS07D	I <sub>R</sub>			50	μA
		RS07G	I <sub>R</sub>			50	μA
		RS07J	I <sub>R</sub>			50	μA
		RS07K	I <sub>R</sub>			150	μA
		RS07B	t <sub>rr</sub>			150	ns
		Reverse recovery time	I <sub>F</sub> = 0.5 A, I <sub>R</sub> = 1 A, I <sub>rr</sub> = 0.25 A	RS07D	t <sub>rr</sub>		
RS07G	t <sub>rr</sub>					150	ns
RS07J	t <sub>rr</sub>					250	ns
RS07K	t <sub>rr</sub>					300	ns
RS07B	C <sub>j</sub>					9	pF
Typical capacitance	4 V, 1 MHz	RS07D	C <sub>j</sub>			9	pF
		RS07G	C <sub>j</sub>			9	pF
		RS07J	C <sub>j</sub>			9	pF
		RS07K	C <sub>j</sub>			4	pF

**Note**

<sup>(1)</sup> Pulse test: 300 μs pulse width, 1 % duty cycle

**TYPICAL CHARACTERISTICS (T<sub>amb</sub> = 25 °C, unless otherwise specified)**

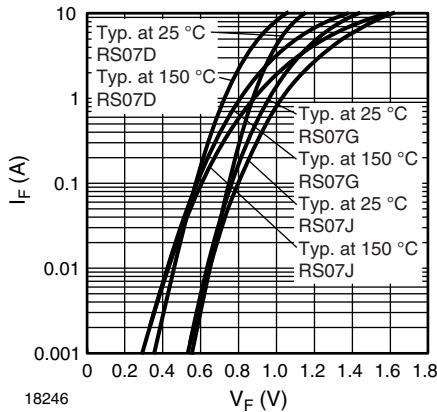

Fig. 1 - Typical Forward Characteristics

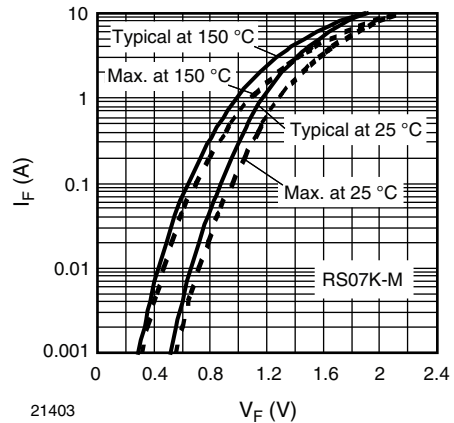

Fig. 2 - Typical Forward Characteristics

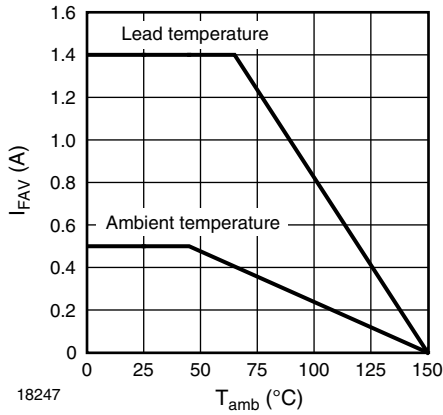

Fig. 3 - Forward Current Derating Curve

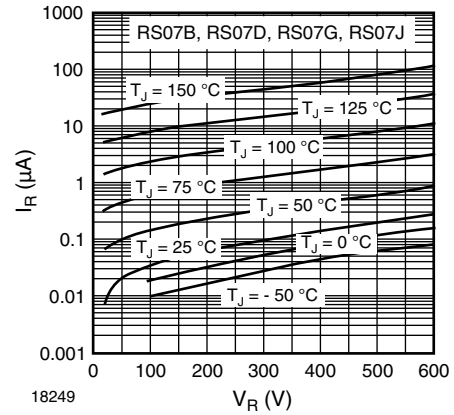

Fig. 6 - Typical Reverse Characteristics

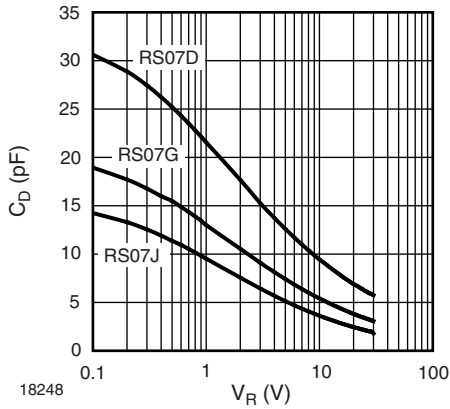

Fig. 4 - Typical Diode Capacitance vs. Reverse Voltage

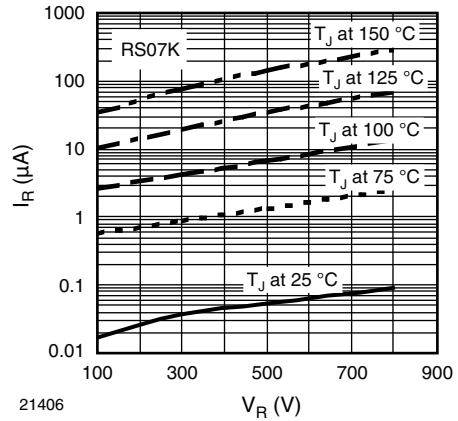

Fig. 7 - Typical Reverse Characteristics

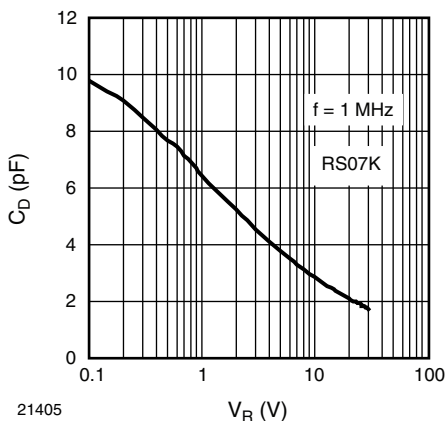
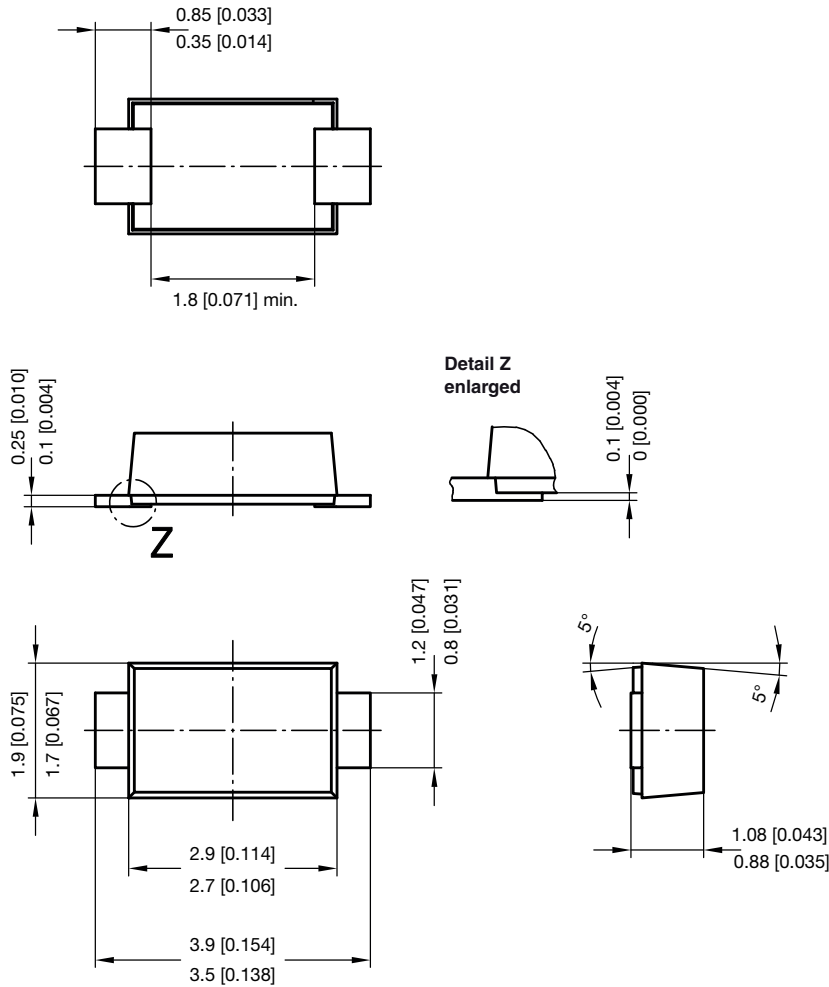

Fig. 5 - Typical Diode Capacitance vs. Reverse Voltage



## PACKAGE DIMENSIONS in millimeters (inches): SMF (DO-219AB)



foot print recommendation:

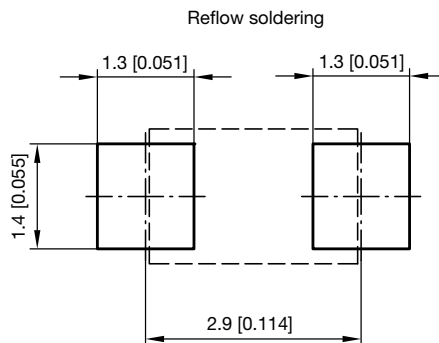

Created - Date: 15. February 2005  
Rev. 6 - Date: 24.Feb.2021  
Document no.: S8-V-3915.01-001 (4)  
22989



## ORIENTATION IN CARRIER TAPE - SMF (DO-219 AB)

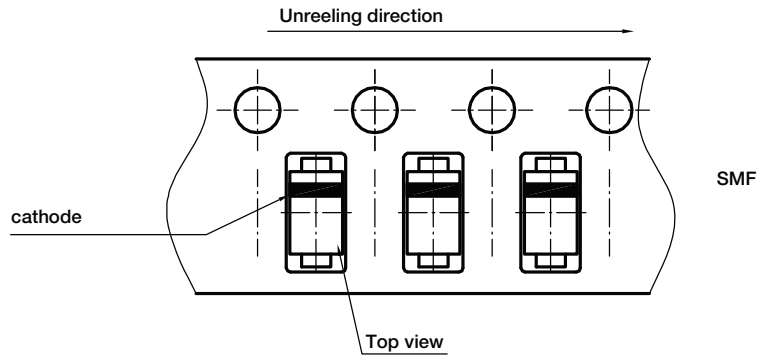

Document no.: S8-V-3717.02-003 (4)  
Created - Date: 09. Feb. 2010  
22670



## **Disclaimer**

ALL PRODUCT, PRODUCT SPECIFICATIONS AND DATA ARE SUBJECT TO CHANGE WITHOUT NOTICE TO IMPROVE RELIABILITY, FUNCTION OR DESIGN OR OTHERWISE.

Vishay Intertechnology, Inc., its affiliates, agents, and employees, and all persons acting on its or their behalf (collectively, "Vishay"), disclaim any and all liability for any errors, inaccuracies or incompleteness contained in any datasheet or in any other disclosure relating to any product.

Vishay makes no warranty, representation or guarantee regarding the suitability of the products for any particular purpose or the continuing production of any product. To the maximum extent permitted by applicable law, Vishay disclaims (i) any and all liability arising out of the application or use of any product, (ii) any and all liability, including without limitation special, consequential or incidental damages, and (iii) any and all implied warranties, including warranties of fitness for particular purpose, non-infringement and merchantability.

Statements regarding the suitability of products for certain types of applications are based on Vishay's knowledge of typical requirements that are often placed on Vishay products in generic applications. Such statements are not binding statements about the suitability of products for a particular application. It is the customer's responsibility to validate that a particular product with the properties described in the product specification is suitable for use in a particular application. Parameters provided in datasheets and / or specifications may vary in different applications and performance may vary over time. All operating parameters, including typical parameters, must be validated for each customer application by the customer's technical experts. Product specifications do not expand or otherwise modify Vishay's terms and conditions of purchase, including but not limited to the warranty expressed therein.

Hyperlinks included in this datasheet may direct users to third-party websites. These links are provided as a convenience and for informational purposes only. Inclusion of these hyperlinks does not constitute an endorsement or an approval by Vishay of any of the products, services or opinions of the corporation, organization or individual associated with the third-party website. Vishay disclaims any and all liability and bears no responsibility for the accuracy, legality or content of the third-party website or for that of subsequent links.

Except as expressly indicated in writing, Vishay products are not designed for use in medical, life-saving, or life-sustaining applications or for any other application in which the failure of the Vishay product could result in personal injury or death. Customers using or selling Vishay products not expressly indicated for use in such applications do so at their own risk. Please contact authorized Vishay personnel to obtain written terms and conditions regarding products designed for such applications.

No license, express or implied, by estoppel or otherwise, to any intellectual property rights is granted by this document or by any conduct of Vishay. Product names and markings noted herein may be trademarks of their respective owners.