



STPS20L25CT/CG

LOW DROP POWER SCHOTTKY RECTIFIER

MAIN PRODUCT CHARACTERISTICS

$I_{F(AV)}$	2 x 10 A
V_{RRM}	25 V
T_j (max)	150 °C
V_F (max)	0.35 V

FEATURES AND BENEFITS

- VERY LOW FORWARD VOLTAGE DROP FOR LESS POWER DISSIPATION AND REDUCED HEATSINK
- OPTIMIZED CONDUCTION/REVERSE LOSSES TRADE-OFF WHICH MEANS THE HIGHEST EFFICIENCY IN THE APPLICATIONS
- AVALANCHE CAPABILITY SPECIFIED

DESCRIPTION

Dual center tap Schottky rectifier suited to Switched Mode Power Supplies and high frequency DC to DC converters.

Packaged in TO-220AB and D²PAK, this device is especially intended for use as a rectifier at the secondary of 3.3V SMPS units.

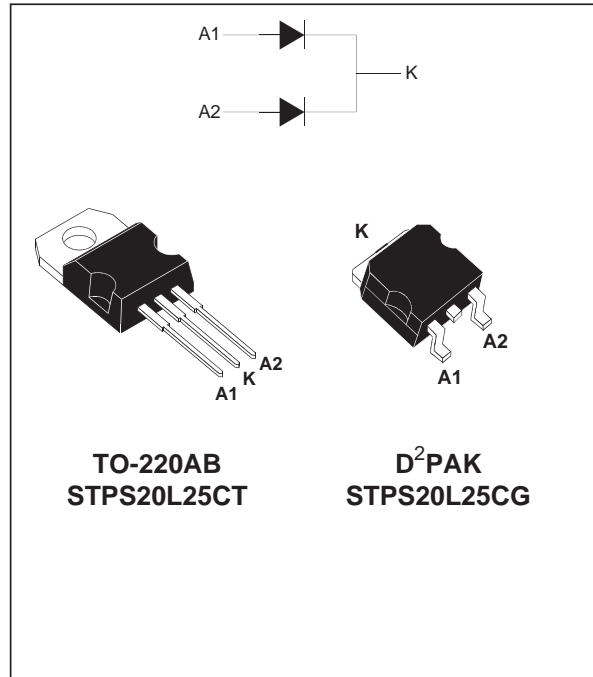

TO-220AB
STPS20L25CT

D²PAK
STPS20L25CG

ABSOLUTE RATINGS (limiting values, per diode)

Symbol	Parameter	Value	Unit
V_{RRM}	Repetitive peak reverse voltage	25	V
$I_{F(RMS)}$	RMS forward current	30	A
$I_{F(AV)}$	Average forward current	$T_c = 145^\circ\text{C}$ $\delta = 0.5$ Per diode: 10 Per device: 20	A
I_{FSM}	Surge non repetitive forward current	$t_p = 10$ ms Sinusoidal	220 A
I_{RRM}	Repetitive peak reverse current	$t_p = 2$ μs square F=1kHz	1 A
I_{RSM}	Non repetitive peak reverse current	$t_p = 100$ μs square	3 A
P_{ARM}	Repetitive peak avalanche power	$t_p = 1$ μs $T_j = 25^\circ\text{C}$	5300 W
T_{stg}	Storage temperature range	- 65 to + 150	°C
T_j	Maximum operating junction temperature *	150	°C
dV/dt	Critical rate of rise of reverse voltage	10000	V/ μs

* : $\frac{dP_{tot}}{dT_j} < \frac{1}{R_{th(j-a)}}$ thermal runaway condition for a diode on its own heatsink

STPS20L25CT/CG

THERMAL RESISTANCES

Symbol	Parameter		Value	Unit
R _{th(j-c)}	Junction to case	Per diode	1.5	°C/W
		Total	0.8	
R _{th(c)}		Coupling	0.1	

When the diodes 1 and 2 are used simultaneously :

$$\Delta T_{j(\text{diode } 1)} = P(\text{diode } 1) \times R_{th(j-c)}(\text{Per diode}) + P(\text{diode } 2) \times R_{th(c)}$$

STATIC ELECTRICAL CHARACTERISTICS (per diode)

Symbol	Tests conditions	Tests conditions	Min.	Typ.	Max.	Unit
I _R *	Reverse leakage current	T _j = 25°C	V _R = V _{RRM}		800	μA
		T _j = 125°C		125	250	mA
V _F *	Forward voltage drop	T _j = 25°C	I _F = 10 A		0.46	V
		T _j = 125°C	I _F = 10 A	0.30	0.35	
		T _j = 25°C	I _F = 20 A		0.56	
		T _j = 125°C	I _F = 20 A	0.41	0.48	

Pulse test: * t_p = 380 μs, δ < 2%

To evaluate the maximum conduction losses use the following equation :

$$P = 0.22 \times I_{F(AV)} + 0.013 \times I_{F(RMS)}^2$$

Fig. 1: Average forward power dissipation versus average forward current.

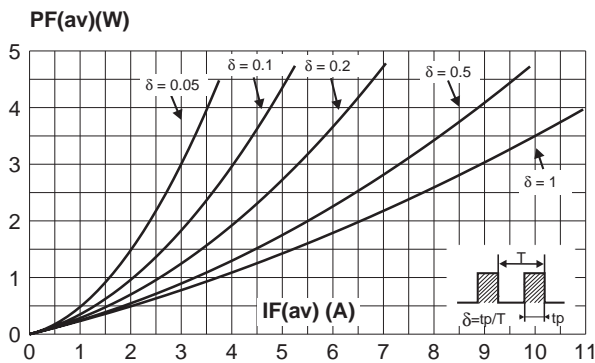

Fig. 3: Normalized avalanche power derating versus pulse duration.

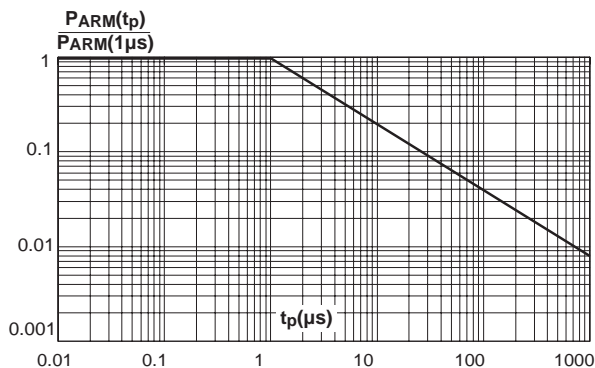

Fig. 2: Average forward current versus ambient temperature (δ = 0.5).

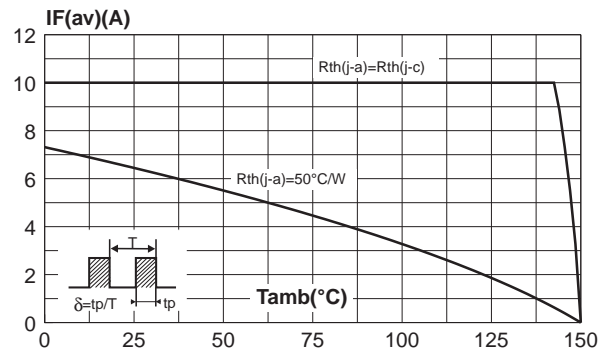

Fig. 4: Normalized avalanche power derating versus junction temperature.

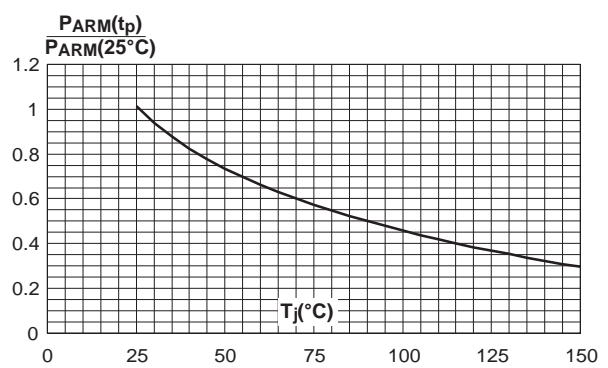

Fig. 5: Non repetitive surge peak forward current versus overload duration (maximum values).

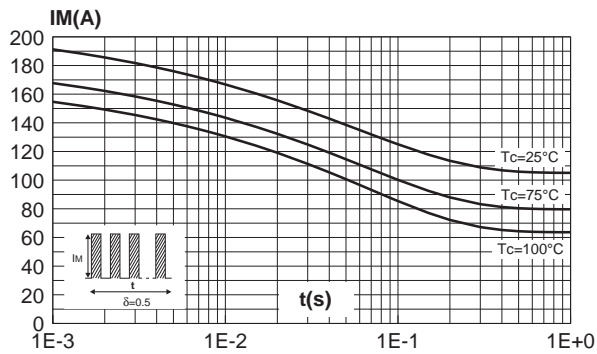

Fig. 6: Relative variation of thermal impedance junction to case versus pulse duration.

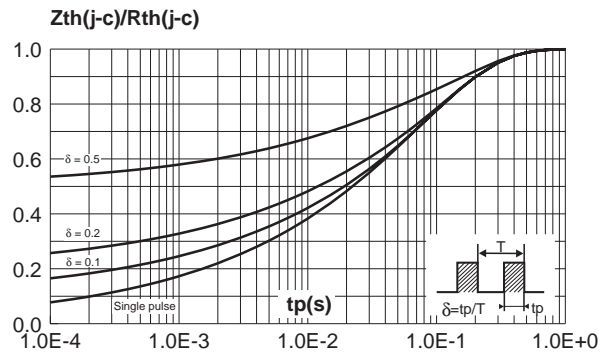

Fig. 7: Reverse leakage current versus reverse voltage applied (typical values).

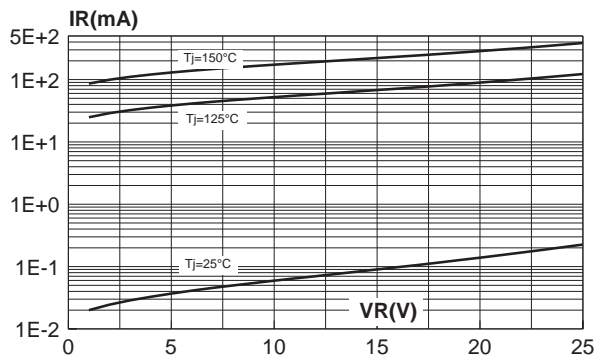

Fig. 8: Junction capacitance versus reverse voltage applied (typical values).

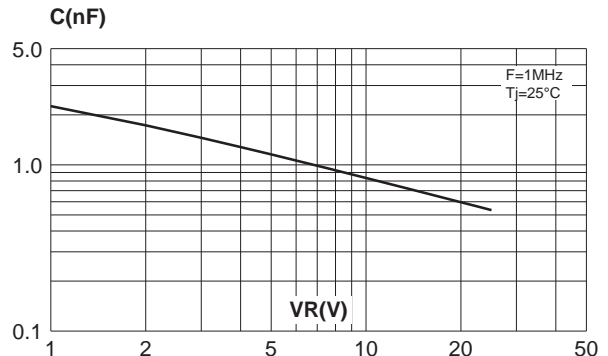

Fig. 9: Forward voltage drop versus forward current (maximum values).

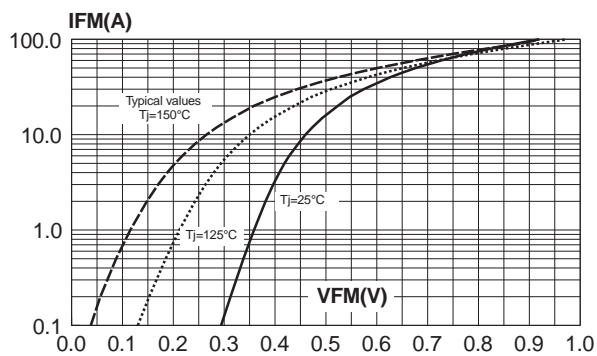
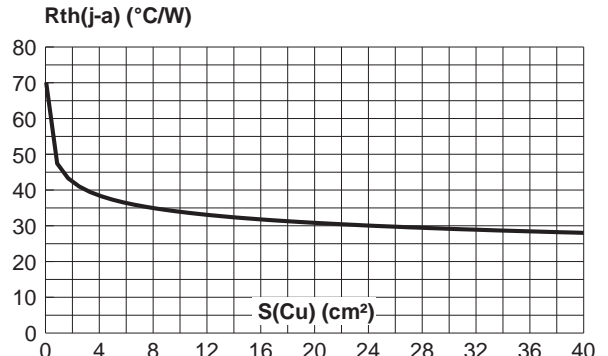
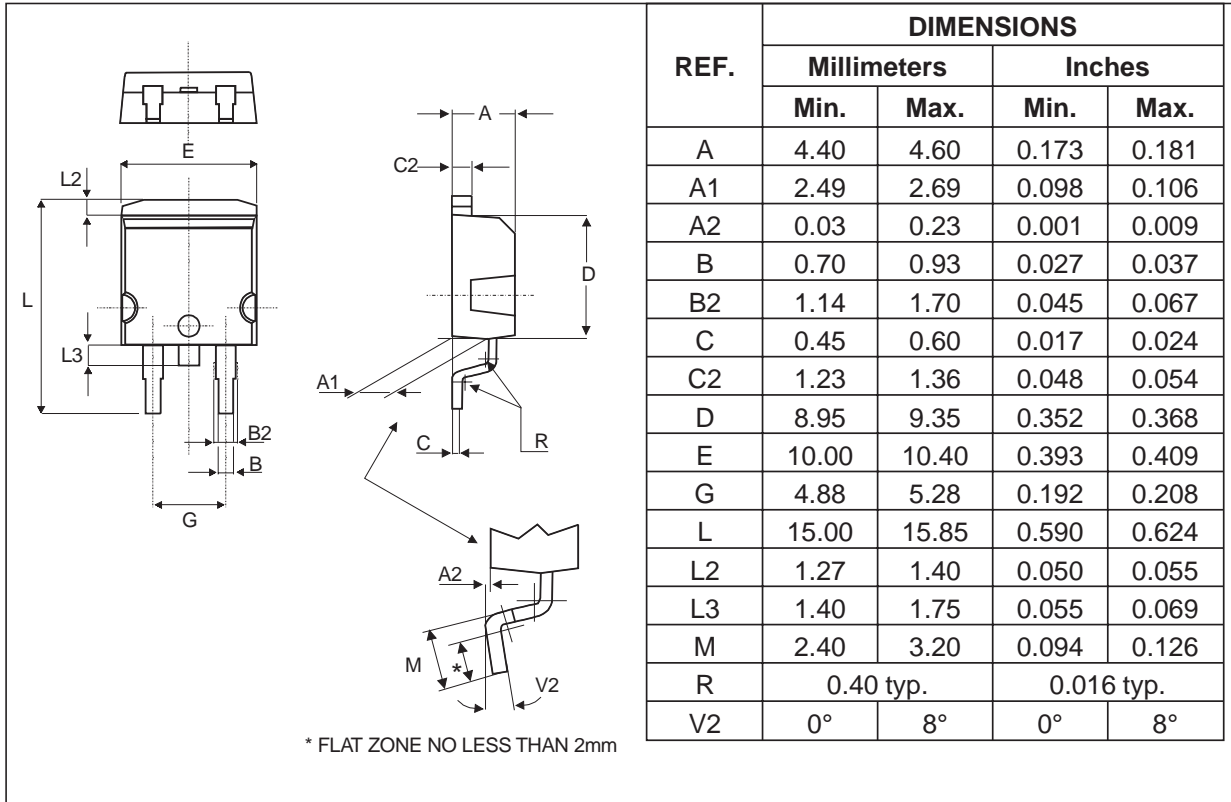

Fig. 10: Thermal resistance junction to ambient versus copper surface under tab (Epoxy printed circuit board FR4, copper thickness : 35 μm). (STPS20L25G only)



STPS20L25CT/CG

PACKAGE MECHANICAL DATA
D²PAK



FOOTPRINT DIMENSIONS (in millimeters)

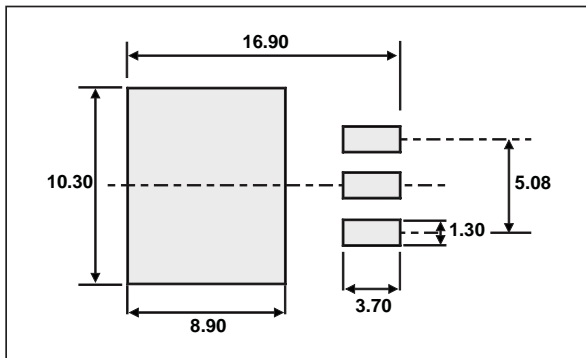

- COOLING METHOD: BY CONDUCTION (METHOD C)

PACKAGE MECHANICAL DATA
TO-220AB

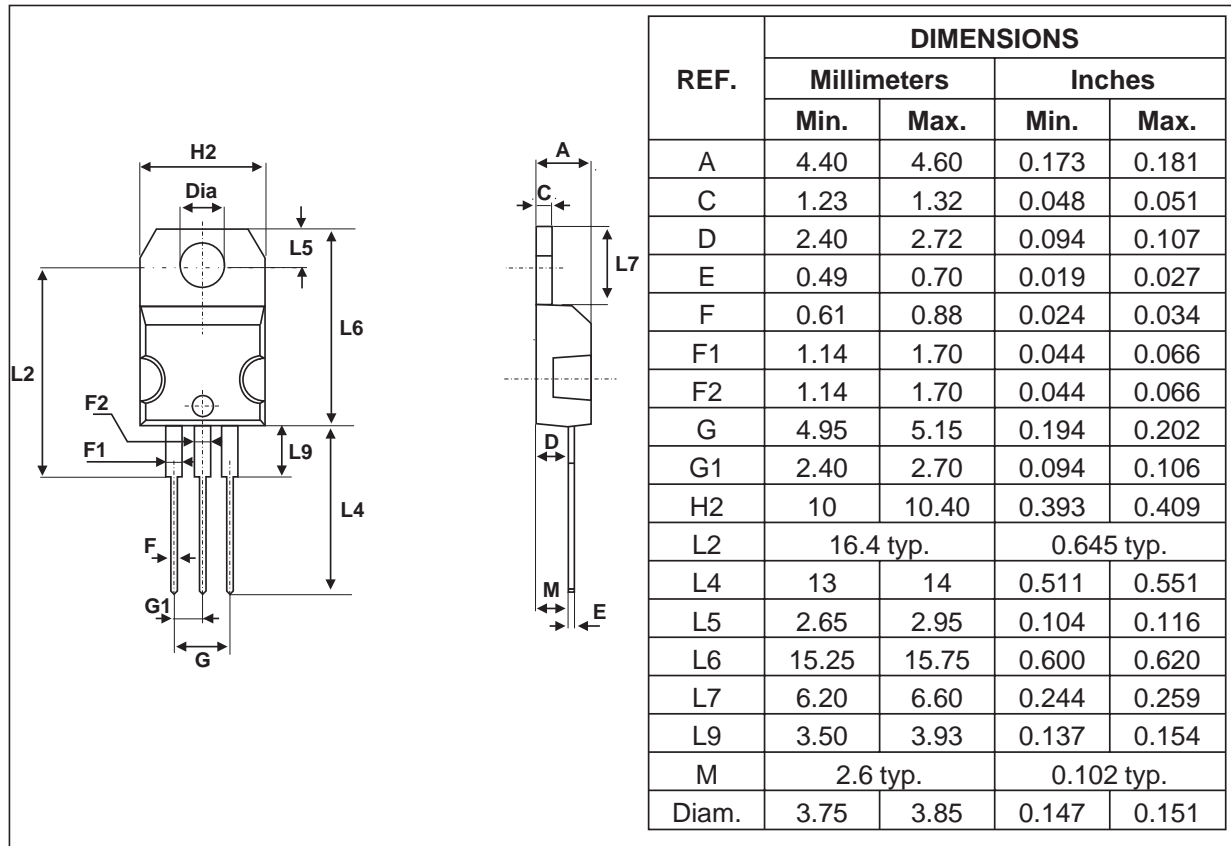

- COOLING METHOD : C
- RECOMMENDED TORQUE VALUE : 0.55 M.N
- MAXIMUM TORQUE VALUE : 0.70 M.N

Ordering type	Marking	Package	Weight	Base qty	Delivery mode
STPS20L25CT	STPS20L25CT	TO-220AB	2.23g	50	Tube
STPS20L25CG	STPS20L25CG	D ² PAK	1.48g	50	Tube
STPS20L25CG-TR	STPS20L25CG	D ² PAK	1.48g	1000	Tape & reel

- EPOXY MEETS UL94,V0

Information furnished is believed to be accurate and reliable. However, STMicroelectronics assumes no responsibility for the consequences of use of such information nor for any infringement of patents or other rights of third parties which may result from its use. No license is granted by implication or otherwise under any patent or patent rights of STMicroelectronics. Specifications mentioned in this publication are subject to change without notice. This publication supersedes and replaces all information previously supplied. STMicroelectronics products are not authorized for use as critical components in life support devices or systems without express written approval of STMicroelectronics.

The ST logo is a registered trademark of STMicroelectronics
 © 2003 STMicroelectronics - Printed in Italy - All rights reserved.
 STMicroelectronics GROUP OF COMPANIES
 Australia - Brazil - Canada - China - Finland - France - Germany
 Hong Kong - India - Israel - Italy - Japan - Malaysia - Malta - Morocco - Singapore
 Spain - Sweden - Switzerland - United Kingdom - United States.

<http://www.st.com>

