

DDR3 SDRAM Memory

Product Guide

SAMSUNG ELECTRONICS RESERVES THE RIGHT TO CHANGE PRODUCTS, INFORMATION AND SPECIFICATIONS WITHOUT NOTICE.

Products and specifications discussed herein are for reference purposes only. All information discussed herein is provided on an "AS IS" basis, without warranties of any kind.

This document and all information discussed herein remain the sole and exclusive property of Samsung Electronics. No license of any patent, copyright, mask work, trademark or any other intellectual property right is granted by one party to the other party under this document, by implication, estoppel or otherwise.

Samsung products are not intended for use in life support, critical care, medical, safety equipment, or similar applications where product failure could result in loss of life or personal or physical harm, or any military or defense application, or any governmental procurement to which special terms or provisions may apply.

For updates or additional information about Samsung products, contact your nearest Samsung office.

All brand names, trademarks and registered trademarks belong to their respective owners.

© 2015 Samsung Electronics Co., Ltd. All rights reserved.

1. DDR3 SDRAM MEMORY ORDERING INFORMATION

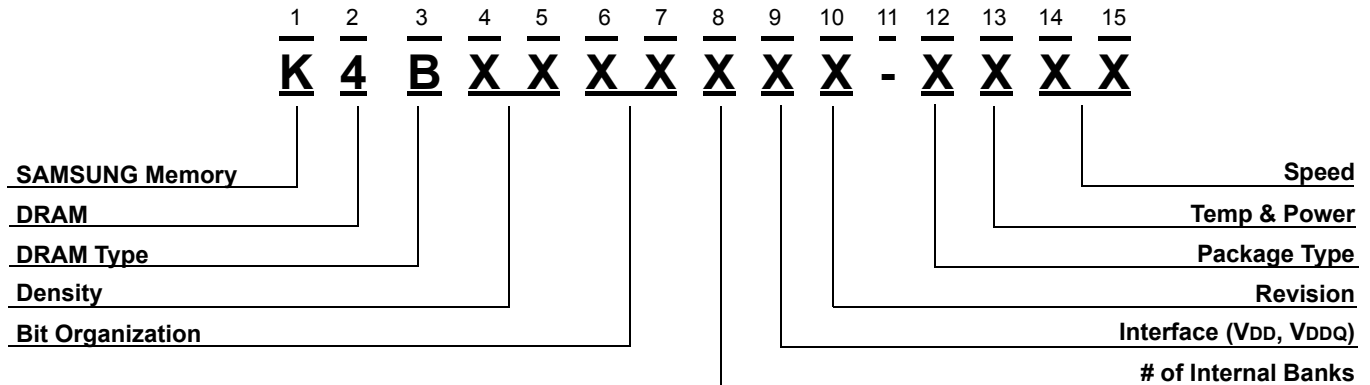
**1. SAMSUNG Memory : K****2. DRAM : 4****3. DRAM Type**

B : DDR3 SDRAM

4~5. Density

51 : 512Mb
 1G : 1Gb
 2G : 2Gb
 4G : 4Gb
 8G : 8Gb

6~7. Bit Organization

04 : x 4
 08 : x 8
 16 : x16
 33 : x32

8. # of Internal Banks

3 : 4 Banks
 4 : 8 Banks
 5 : 16 Banks

9. Interface (VDD, VDDQ)

6 : SSTL (1.5V, 1.5V)

10. Revision

M : 1st Gen.
 A : 2nd Gen.
 B/Q : 3rd Gen.
 C : 4th Gen.
 D : 5th Gen.
 E : 6th Gen.
 F : 7th Gen.
 G : 8th Gen.

11. "-"**12. Package Type**

H : FBGA (Halogen-free & Lead-free)
 M : FBGA (Halogen-free & Lead-free, DDP)
 B : FBGA (Halogen-free & Lead-free, Flip Chip)
 E : FBGA(Lead-free & Halogen-free, QDP)
 O : FBGA(Lead-free & Halogen-free, QDP for 64GB LRDIMM)

13. Temp & Power

C : Commercial Temp.(0°C ~ 85°C) & Normal Power(1.5V)
 Y : Commercial Temp.(0°C ~ 85°C) & Low VDD(1.35V)

14~15. Speed

F7 : DDR3-800 (400MHz @ CL=6, tRCD=6, tRP=6)
 F8 : DDR3-1066 (533MHz @ CL=7, tRCD=7, tRP=7)
 H9 : DDR3-1333 (667MHz @ CL=9, tRCD=9, tRP=9)
 K0 : DDR3-1600 (800MHz @ CL=11, tRCD=11, tRP=11)
 MA : DDR3-1866 (933MHz @ CL=13, tRCD=13, tRP=13)
 NB : DDR3-2133 (1066MHz @ CL=14, tRCD=14, tRP=14)

2. DDR3 SDRAM Component Product Guide

Density	Banks	Part Number	Package & Power, Temp. & Speed	Org.	VDD Voltage ¹	PKG	Avail.	NOTE
2Gb Q-die	8Banks	K4B2G0446Q	BCH9/K0/MA	512Mx4	1.5V	78 ball FBGA	EOL Q1'16	
		K4B2G0846Q	BCH9/K0/MA	256Mx8		96ball FBGA	MP	
		K4B2G1646Q	BCH9/K0/MA	128Mx16				
		K4B2G0446Q	BYH9/K0/MA	512Mx4	1.35V	78 ball FBGA	EOL Q1'16	
		K4B2G0846Q	BYH9/K0/MA	256Mx8		96ball FBGA	MP	
		K4B2G1646Q	BYH9/K0/MA	128Mx16				
4Gb Q-die	8Banks	K4B4G0446Q	HCH9/K0/MA	1Gx4	1.5V	78 ball FBGA	EOL Q1'16	
		K4B4G0846Q	HCH9/K0/MA	512Mx8		96ball FBGA	MP	
		K4B4G1646Q	HCH9/K0/MA	256Mx16				
		K4B4G0446Q	HYH9/K0/MA	1Gx4	1.35V	78 ball FBGA	EOL Q1'16	
		K4B4G0846Q	HYH9/K0/MA	512Mx8		96ball FBGA	MP	
		K4B4G1646Q	HYH9/K0/MA	256Mx16				
4Gb D-die	8Banks	K4B4G0446D	BCH9/K0/MA	1Gx4	1.5V	78 ball FBGA	MP	
		K4B4G0846D	BCH9/K0/MA	512Mx8		96ball FBGA		
		K4B4G1646D	BCH9/K0/MA	256Mx16				
		K4B4G0446D	BYH9/K0/MA	1Gx4	1.35V	78 ball FBGA	MP	
		K4B4G0846D	BYH9/K0/MA	512Mx8		96ball FBGA		
		K4B4G1646D	BYH9/K0/MA	256Mx16				
4Gb E-die	8Banks	K4A4G045WE	BCH9/K0/MA	1Gx4	1.5V	78 ball FBGA	MP	
		K4A4G085WE	BCH9/K0/MA	512Mx8		96ball FBGA		
		K4A4G165WE	BCH9/K0/MA	256Mx16				
		K4A4G045WE	BYH9/K0/MA	1Gx4	1.35V	78 ball FBGA	MP	
		K4A4G085WE	BYH9/K0/MA	512Mx8		96ball FBGA		
		K4A4G165WE	BYH9/K0/MA	256Mx16				

3. DDR3 SDRAM Module Ordering Information

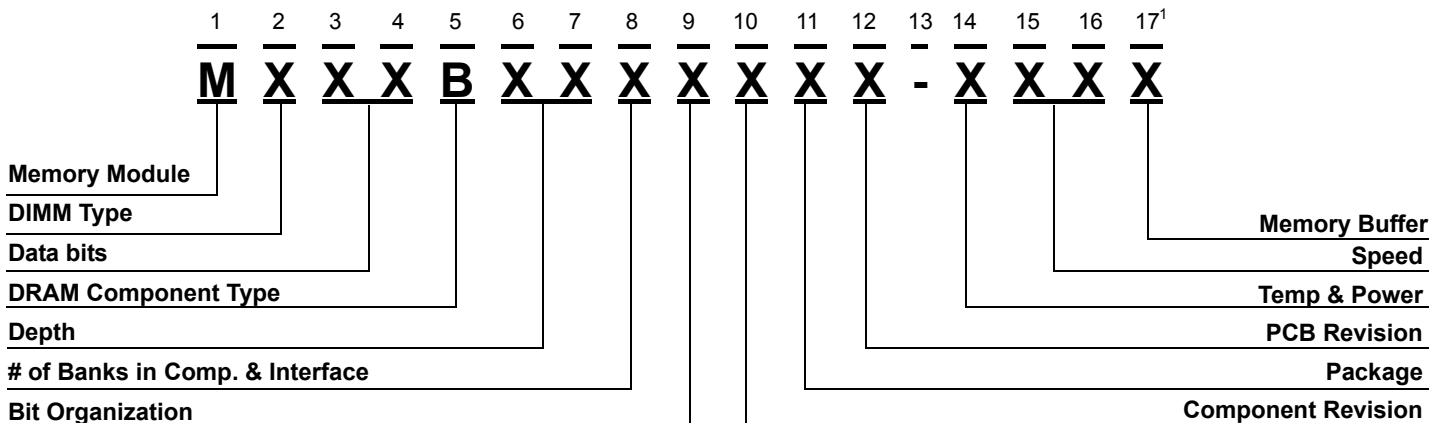

1. Memory Module : M

2. DIMM Type

- 3 : DIMM
- 4 : SODIMM

3~4. Data Bits

- 71 : x64 204pin Unbuffered SODIMM
- 74 : x72 204pin ECC Unbuffered SODIMM
- 78 : x64 240pin Unbuffered DIMM
- 86 : x72 240pin LR DIMM
- 90 : x72 240pin VLP Unbuffered DIMM
- 91 : x72 240pin ECC Unbuffered DIMM
- 92 : x72 240pin VLP Registered DIMM
- 93 : x72 240pin Registered DIMM

5. DRAM Component Type

- B : DDR3 SDRAM

6~7. Depth

- 32 : 32M
- 64 : 64M
- 28 : 128M
- 56 : 256M
- 51 : 512M
- 1G : 1G
- 2G : 2G
- 4G : 4G
- 8G : 8G
- 33 : 32M (for 128Mb/512Mb)
- 65 : 64M (for 128Mb/512Mb)
- 29 : 128M (for 128Mb/512Mb)
- 57 : 256M (for 512Mb/2Gb)
- 52 : 512M (for 512Mb/2Gb)
- 1K : 1G (for 2Gb)
- 2K : 2G (for 2Gb)

8. # of Banks in comp. & Interface

- 7 : 8Banks & SSTL-1.5V

9. Bit Organization

- 0 : x 4
- 3 : x 8
- 4 : x16

10. Component Revision

- M : 1st Gen.
- B/Q : 3rd Gen.
- D : 5th Gen.
- F : 7th Gen.
- A : 2nd Gen.
- C : 4th Gen.
- E : 6th Gen.
- G : 8th Gen.

11. Package

- H : FBGA(Lead-free & Halogen-free)
- M : FBGA(Lead-free & Halogen-free, DDP)
- B : FBGA (Halogen-free & Lead-free, Flip Chip)
- E : FBGA(Lead-free & Halogen-free, QDP)
- O : FBGA(Lead-free & Halogen-free, QDP for 64GB LRDIMM)

12. PCB Revision

- 0 : None
- 2 : 2nd Rev.
- 4 : 4th Rev.
- 1 : 1st Rev.
- 3 : 3rd Rev.
- S : Reduced Layer

13. "-"

14. Temp & Power

- C : Commercial Temp.(0°C ~ 85°C) & Normal Power(1.5V)
- Y : Commercial Temp.(0°C ~ 85°C) & Low VDD(1.35V)

15~16. Speed²

- F7 : DDR3-800 (400MHz @ CL=6, tRCD=6, tRP=6)
- F8 : DDR3-1066 (533MHz @ CL=7, tRCD=7, tRP=7)
- H9 : DDR3-1333 (667MHz @ CL=9, tRCD=9, tRP=9)
- K0 : DDR3-1600 (800MHz @ CL=11, tRCD=11, tRP=11)
- MA : DDR3-1866 (933MHz @ CL=13, tRCD=13, tRP=13)

17. Memory Buffer

- 0 : Inphi iMB02-GS02A
- 1 : IDT A2 (Greendale)
- 2 : Montage MB C0
- 3 : Inphi iMB02-GS02B
- 4 : Montage MB C1

NOTE:

1. Only used for LRDIMM
2. PC3-6400(DDR3-800), PC3-8500(DDR3-1066), PC3-10600(DDR3-1333), PC3-12800(DDR3-1600), PC3-14900(DDR3-1866)

4. DDR3 SDRAM Module Product Guide

4.1 240Pin DDR3 Registered DIMM

240Pin DDR3 Registered DIMM													
Org.	Density	Part Number	Speed	Raw Card	Composition	Comp. Version		Internal Banks	Rank	PKG	Height	Avail.	NOTE
1G x 72	8GB	M393B1K70QB0	YK0/CMA	E (2Rx4)	512M x 4 * 36 pcs	2Gb	Q-die	8	2	78ball FBGA	30mm	EOL Q1'16	
1G x 72	8GB	M393B1G70QH0	YK0/CMA	C (1Rx4)	1G x 4 * 18 pcs	4Gb	Q-die	8	1	78ball FBGA	30mm	EOL Q1'16	
1G x 72	8GB	M393B1G73QH0	YK0/CMA	B (2Rx8)	1G x 8 * 18 pcs	4Gb	Q-die	8	2	78ball FBGA	30mm	EOL Q1'16	
1G x 72	8GB	M393B1G70EB0	YK0/CMA	C (1Rx4)	1G x 4 * 18 pcs	4Gb	E-die	8	1	78ball FBGA	30mm	MP	
1G x 72	8GB	M393B1G73EB0	YK0/CMA	B (2Rx8)	1G x 8 * 18 pcs	4Gb	Q-die	8	2	78ball FBGA	30mm	EOL Q1'16	
2G x 72	16GB	M393B2G70QH0	YK0/CMA	E (2Rx4)	1G x 4 * 36 pcs	4Gb	Q-die	8	2	78ball FBGA	30mm	EOL Q1'16	
2G x 72	16GB	M393B2G70DB0	YK0/CMA	E (2Rx4)	1G x 4 * 36 pcs	4Gb	D-die	8	2	78ball FBGA	30mm	MP	
2G x 72	16GB	M393B2G70EB0	YK0/CMA	E (2Rx4)	1G x 4 * 36 pcs	4Gb	E-die	8	2	78ball FBGA	30mm	MP	
4G x 72	32GB	M393B4G70DM0	YH9	AB (4Rx4)	2G DDP x 4 * 36 pcs	4Gb	D-die	8	4	78ball FBGA	30mm	MP	

4.2 240Pin DDR3 LRDIMM

240Pin DDR3 LRDIMM													
Org.	Density	Part Number	Speed	Raw Card	Composition	Comp. Version		Internal Banks	Rank	PKG	Height	Avail.	NOTE
4G x 72	32GB	M386B4G70DM0	YK0/CMA	C (4Rx4)	2G DDP x 4 * 36 pcs	4Gb	D-die	8	4	78ball FBGA	30.35mm	MP	
8G x 72	64GB	M386B8G70DE0	YH9/CK0	E (8Rx4)	4G QDP x 4 * 36 pcs	4Gb	D-die	8	8	78ball FBGA	30.35mm	MP	

4.3 240Pin DDR3 VLP Registered DIMM

240Pin DDR3 VLP Registered DIMM													
Org.	Density	Part Number	Speed	Raw Card	Composition	Comp. Version		Internal Banks	Rank	PKG	Height	Avail.	NOTE
1G x 72	8GB	M392B1G73DB0	YK0/CMA	L (2Rx8)	1G x 8 * 18pcs	4Gb	D-die	8	1	78ball FBGA	18.75mm	MP	
1G x 72	8GB	M392B1G70DB0	YK0/CMA	M (1Rx4)	512M x 4 * 18pcs	4Gb	D-die	8	2	78ball FBGA	18.75mm	MP	
2G x 72	16GB	M392B2G70DM0	YK0/CMA	N (2Rx4)	2G DDP x 4 * 18pcs	4Gb	D-die	8	2	78ball FBGA	18.75mm	MP	
4G x 72	32GB	M392B4G70DE0	YH9	U (4Rx4)	4G QDP x 4 * 18pcs	4Gb	D-die	8	4	78ball FBGA	18.75mm	MP	

4.4 204Pin DDR3 ECC SODIMM

204Pin DDR3 ECC SODIMM													
Org.	Density	Part Number	Speed	Raw Card	Composition	Comp. Version		Internal Banks	Rank	PKG	Height	Avail.	NOTE
512M x 64	4GB	M474B5173EB0	YK0	C (1Rx8)	512M x 8 * 9pcs	4Gb	E-die	8	1	78 ball FBGA	30mm	MP	
1G x 64	8GB	M474B1G73QH0	YK0/CMA	D (2Rx8)	512M x 8 * 18pcs	4Gb	Q-die	8	2	78 ball FBGA	30mm	EOL Q1'16	
1G x 64	8GB	M474B1G73EB0	YK0	D (2Rx8)	512M x 8 * 18pcs	4Gb	E-die	8	2	78 ball FBGA	30mm	MP	

4.5 204Pin DDR3 Non ECC SODIMM

204Pin DDR3 Non ECC SODIMM													
Org.	Density	Part Number	Speed	Raw Card	Composition	Comp. Version		Internal Banks	Rank	PKG	Height	Avail.	NOTE
256M x 64	2GB	M471B5674QB0	YK0	C (1Rx16)	256M x 16 * 8 pcs	4Gb	Q-die	8	1	96 ball FBGA	30mm	EOL Q1'16	
256M x 64	2GB	M471B5674EB0	YK0/YMA	C (1Rx16)	256M x 16 * 8 pcs	4Gb	E-die	8	1	96 ball FBGA	30mm	MP	
512M x 64	4GB	M471B5173QH0	YK0	B (1Rx8)	512M x 8 * 8 pcs	4Gb	Q-die	8	1	78 ball FBGA	30mm	EOL Q1'16	
512M x 64	4GB	M471B5173DB0	YK0	B (1Rx8)	512M x 8 * 8 pcs	4Gb	D-die	8	1	78 ball FBGA	30mm	MP	
512M x 64	4GB	M471B5173EB0	YK0/YMA	B (1Rx8)	512M x 8 * 8 pcs	4Gb	E-die	8	1	78 ball FBGA	30mm	MP	
1G x 64	8GB	M471B1G73QH0	YK0	F (2Rx8)	512M x 8 * 16 pcs	4Gb	Q-die	8	2	78 ball FBGA	30mm	EOL Q1'16	
1G x 64	8GB	M471B1G73DB0	YK0	F (2Rx8)	512M x 8 * 16 pcs	4Gb	D-die	8	2	78 ball FBGA	30mm	MP	
1G x 64	8GB	M471B1G73EB0	YK0/YMA	F (2Rx8)	512M x 8 * 16 pcs	4Gb	E-die	8	2	78 ball FBGA	30mm	MP	

4.6 240Pin DDR3 ECC UDIMM

240Pin DDR3 ECC UDIMM													
Org.	Density	Part Number	Speed	Raw Card	Composition	Comp. Version		Internal Banks	Rank	PKG	Height	Avail.	NOTE
512M x 64	4GB	M391B5173EB0	YK0/CMA	D (1Rx8)	512M x 8 * 9 pcs	4Gb	E-die	8	1	78 ball FBGA	30mm	MP	
1G x 64	8GB	M391B1G73QH0	YK0/CMA	E (2Rx8)	512M x 8 * 18 pcs	4Gb	Q-die	8	2	78 ball FBGA	30mm	EOL Q1'16	
1G x 64	8GB	M391B1G73EB0	YK0/CMA	E (2Rx8)	512M x 8 * 18 pcs	4Gb	E-die	8	2	78 ball FBGA	30mm	MP	

4.7 240Pin DDR3 Non ECC UDIMM

240Pin DDR3 Non ECC UDIMM													
Org.	Density	Part Number	Speed	Raw Card	Composition	Comp. Version		Internal Banks	Rank	PKG	Height	Avail.	NOTE
256M x 64	2GB	M378B5773QB0	CK0/CMA	A (1Rx8)	256M x 8 * 8 pcs	2Gb	Q-die	8	1	78ball FBGA	30mm	EOL Q1'16	
256M x 64	2GB	M378B5674EB0	YK0/YMA	C (1Rx16)	256M x 16 * 8 pcs	4Gb	E-die	8	1	96ball FBGA	30mm	MP	
512M x 64	4GB	M378B5173QH0	CK0/CMA	A (1Rx8)	512M x 8 * 8 pcs	4Gb	Q-die	8	1	78ball FBGA	30mm	EOL Q1'16	
512M x 64	4GB	M378B5173QH0	YK0/YMA	A (1Rx8)	512M x 8 * 8 pcs	4Gb	Q-die	8	1	78ball FBGA	30mm	EOL Q1'16	
512M x 64	4GB	M378B5173DB0	CK0/CMA	A (1Rx8)	512M x 8 * 8 pcs	4Gb	D-die	8	1	78ball FBGA	30mm	MP	
512M x 64	4GB	M378B5173EB0	CK0/CMA	A (1Rx8)	512M x 8 * 8 pcs	4Gb	E-die	8	1	78ball FBGA	30mm	MP	
512M x 64	4GB	M378B5173EB0	YK0/YMA	A (1Rx8)	512M x 8 * 8 pcs	4Gb	E-die	8	1	78ball FBGA	30mm	MP	
1G x 64	8GB	M378B1G73QH0	CK0/CMA	B (2Rx8)	512M x 8 * 16 pcs	4Gb	Q-die	8	2	78ball FBGA	30mm	EOL Q1'16	
1G x 64	8GB	M378B1G73QH0	YK0/YMA	B (2Rx8)	512M x 8 * 16 pcs	4Gb	Q-die	8	2	78ball FBGA	30mm	EOL Q1'16	
1G x 64	8GB	M378B1G73DB0	CK0/CMA	B (2Rx8)	512M x 8 * 16 pcs	4Gb	D-die	8	2	78ball FBGA	30mm	MP	
1G x 64	8GB	M378B1G73EB0	CK0/CMA	B (2Rx8)	512M x 8 * 16 pcs	4Gb	E-die	8	2	78ball FBGA	30mm	MP	
1G x 64	8GB	M378B1G73EB0	YK0/YMA	B (2Rx8)	512M x 8 * 16 pcs	4Gb	E-die	8	2	78ball FBGA	30mm	MP	

5. RDIMM RCD Information

5.1 RCD Identification in JEDEC Description in Module Label

5.2 Label Example



5.3 RCD Information

- Example

PKG	RCD Vendor	RCD Version(Rev.)	JEDEC Description (Example - 4GB 2Rx8 PC3(L) ¹ - 12800R - 11 - 11 - B1 - XX)
2Gb Q-die	IDT	B1	D3
4Gb D-die	Inphi	XV-GS02	P2
4Gb Q-die	IDT	A1	D4
4Gb E-die	Inphi	UV-GS02	P3

*** NOTE**

1) PC3L is used for 1.35V

2) RCD information is subject to change.

6. LRDIMM Memory Buffer Information

6.1 Label Example



6.2 Memory Buffer Information

- Example

Voltage	Vendor	Revision	Module P/N	JEDEC Description On Label
1.35V	Inphi	iMB02-GS02A	M386B4G70BM0-YH90 ¹	32GB 4Rx4 PC3L-10600L-09-11-C0
	Montage	MB C0	M386B4G70BM0-YH92 ¹	32GB 4Rx4 PC3L-10600L-09-11-C0
1.5V	Inphi	iMB02-GS02A	M386B4G70BM0-CMA3 ¹	32GB 4Rx4 PC3-14900L-13-11-C0
	IDT	A2	M386B4G70BM0-CMA1 ¹	32GB 4Rx4 PC3-14900L-13-11-C0
	Montage	MB C1	M386B4G70BM0-CMA4 ¹	32GB 4Rx4 PC3-14900L-13-11-C0

*** NOTE**

1) The 16th digit refers memory buffer vendor and revision.

0: Inphi iMB02-GS02A

1: IDT A2

2: Montage MB C0

3: Inphi iMB02-GS02B

4: Montage MB C1

2) Memory buffer information is subject to change.

7. Package Dimension

78Ball FBGA for 2Gb Q-die (x4/x8) / 4Gb D-die (x4/x8) / 4Gb E-die (x4/8)

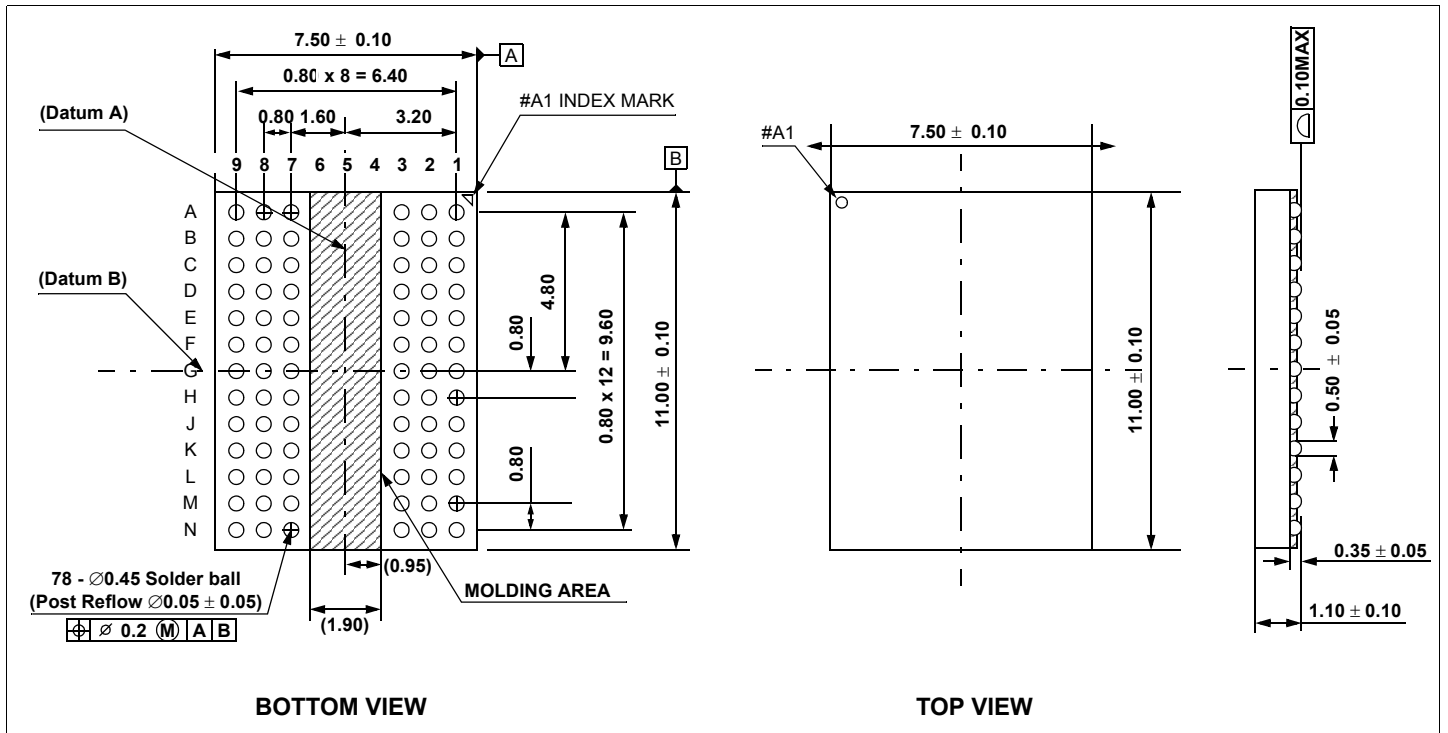

96Ball FBGA for 2Gb Q-die (x16) / 4Gb D-die (x16) / 4Gb E-die (x16)

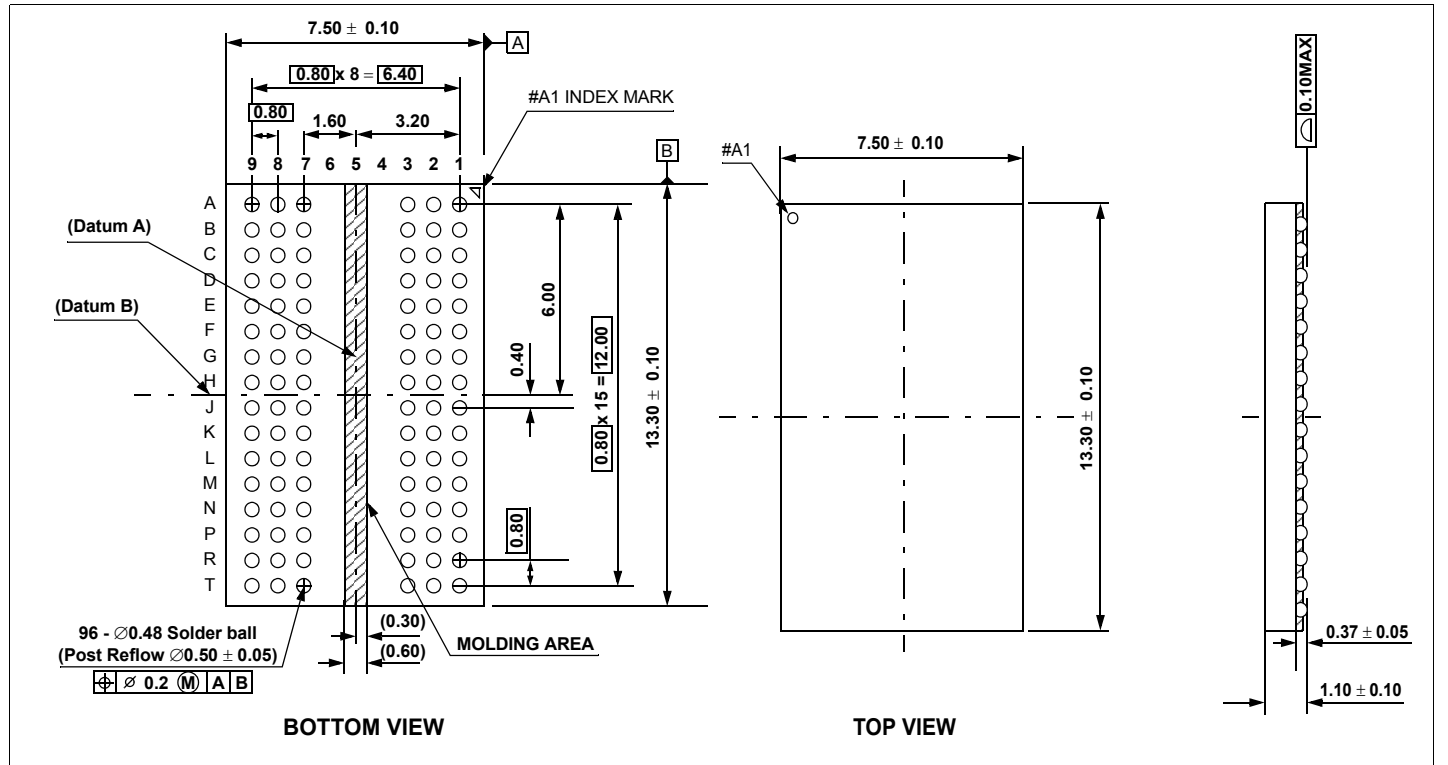

78Ball FBGA for 4Gb Q-die (x4/8)

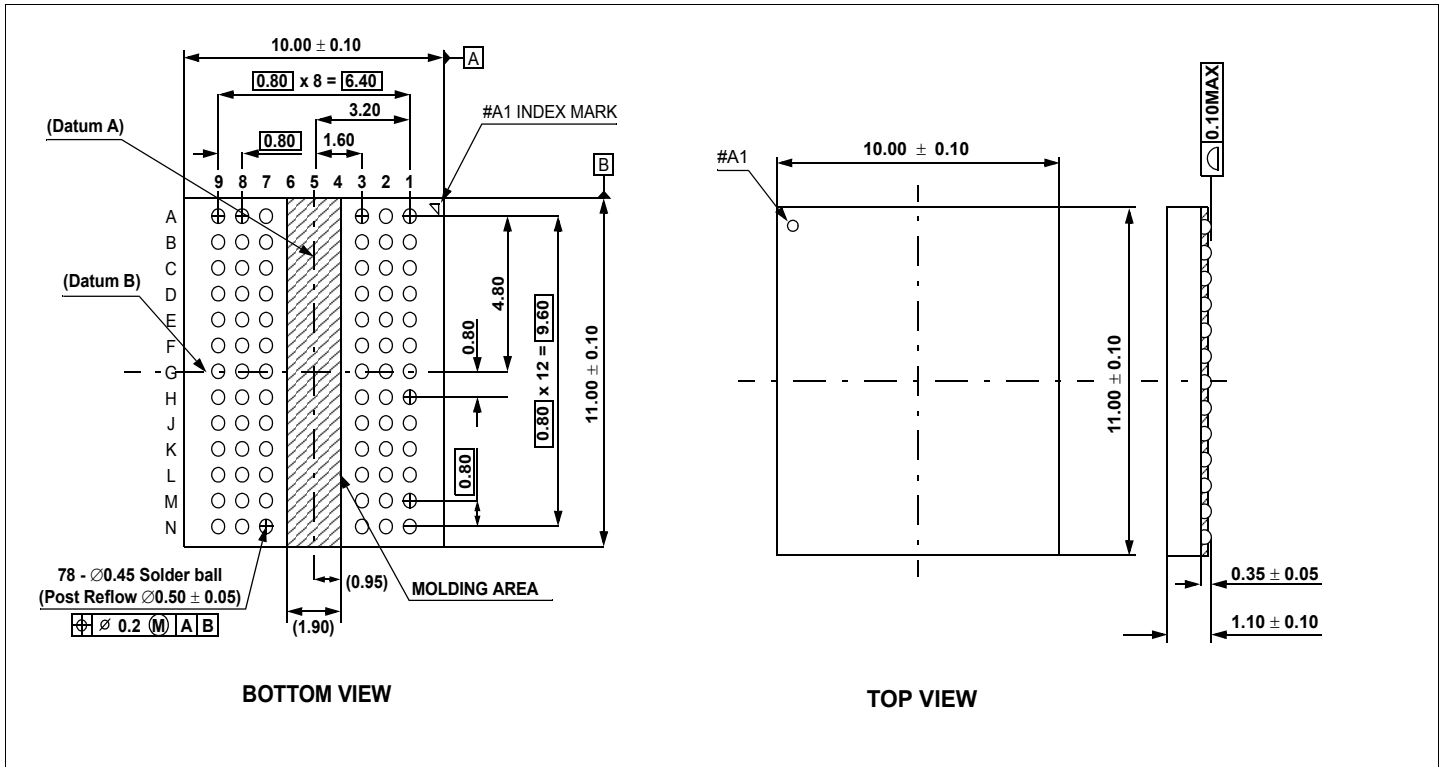

96Ball FBGA for 4Gb Q-die (x16)

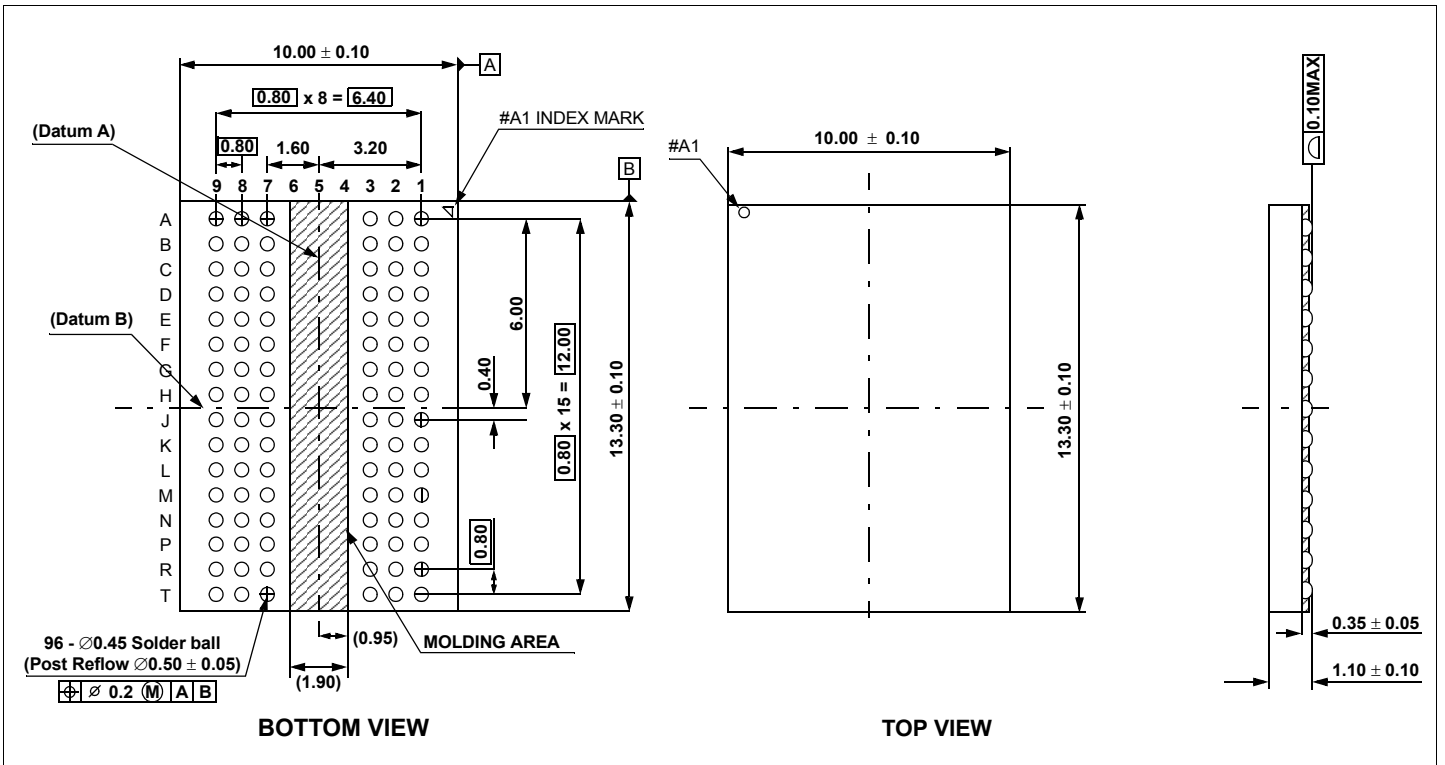

x72 240pin DDR3 SDRAM RDIMM

Units : Millimeters

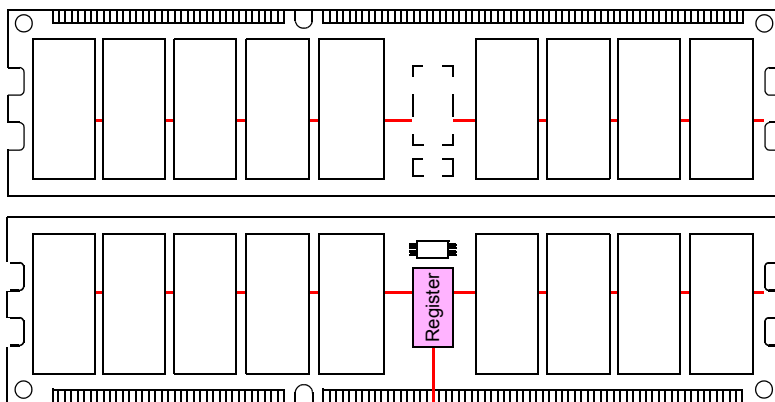
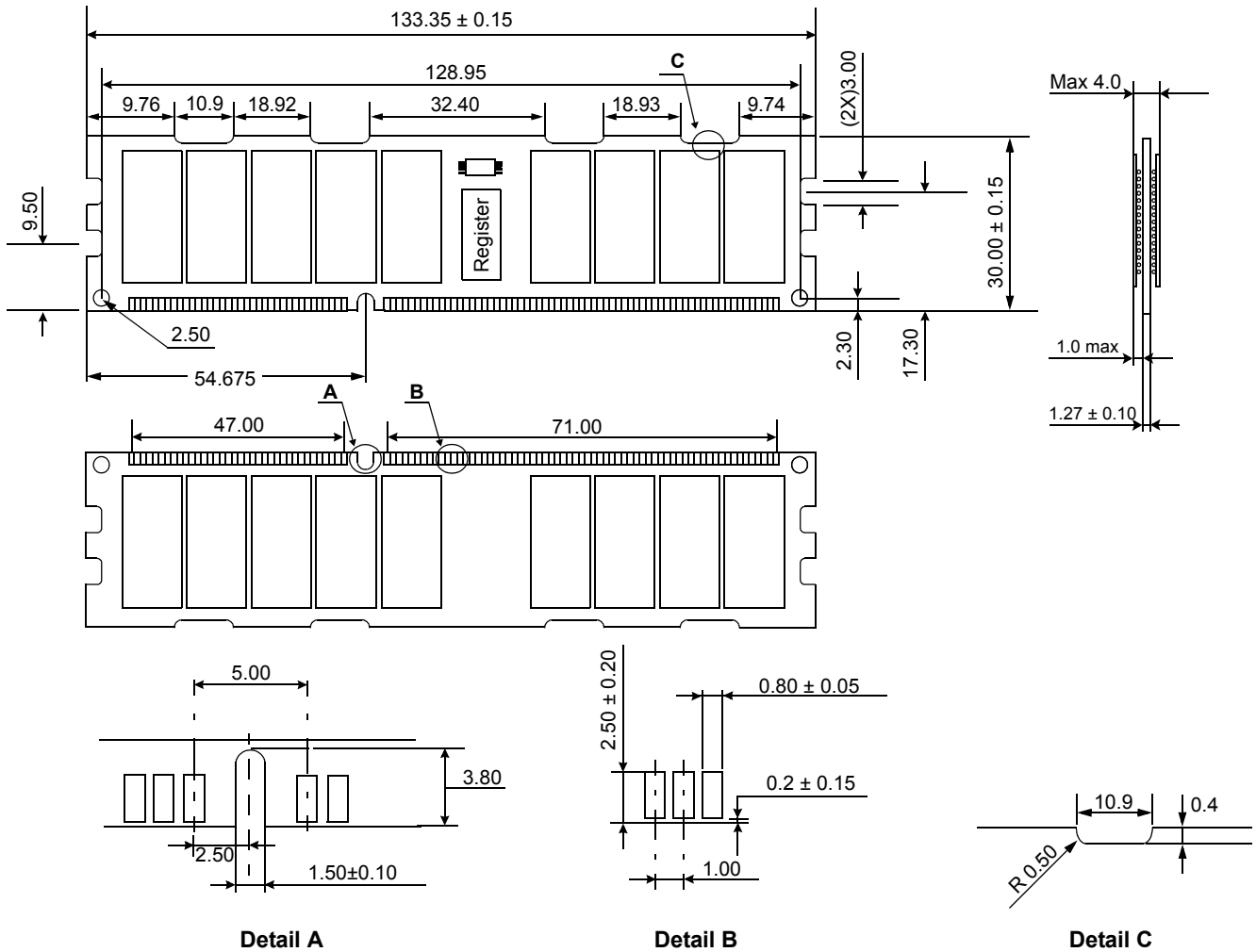

— Address, Command and Control lines

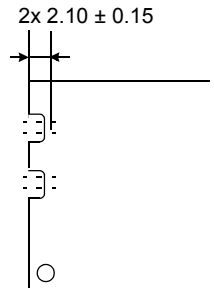

x72 240pin DDR3 SDRAM RDIMM Heat Spreader Design (DDP)
x72 240pin DDR3 SDRAM LRDIMM Heat Spreader Design (DDP)

1. FRONT PART

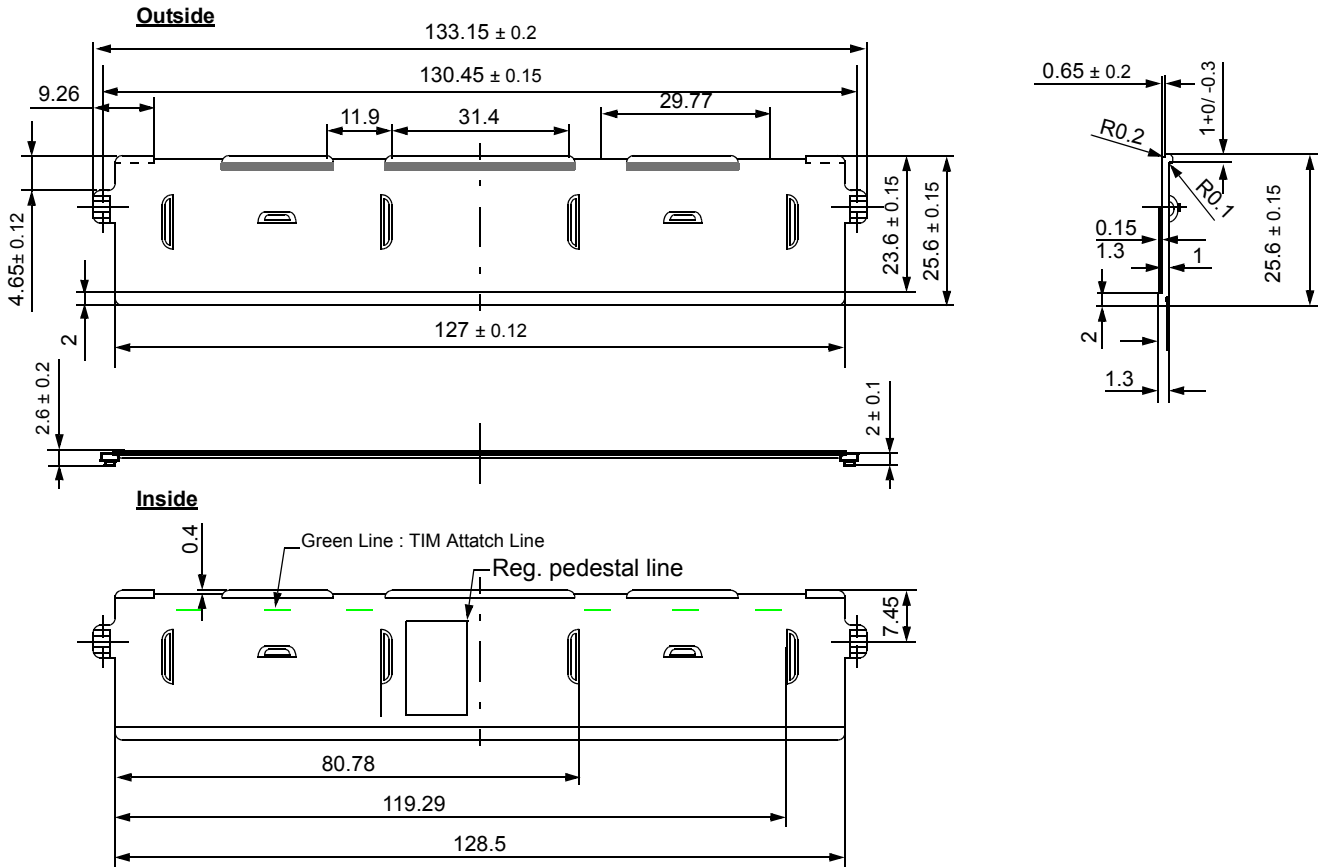

2. BACK PART

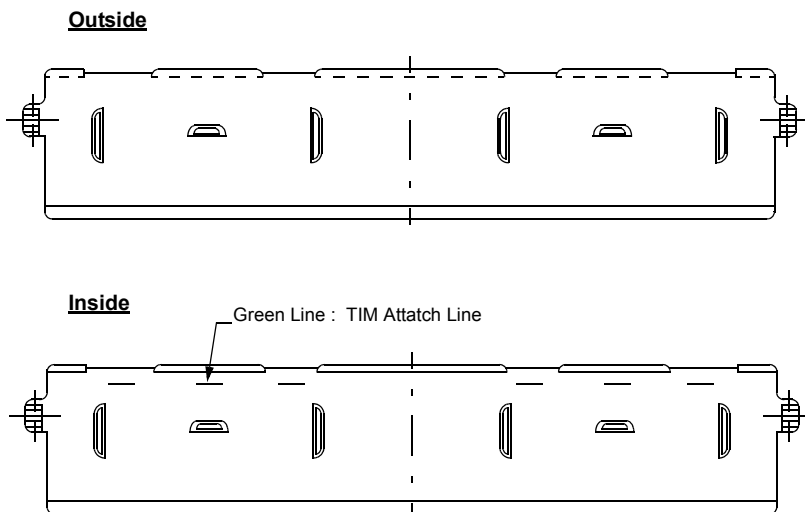

3. CLIP PART

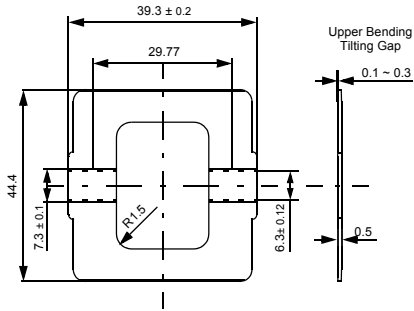

4. DDR3 RDIMM ASS'Y View

Reference thickness total (Maximum) : 7.55mm (With Clip thickness)

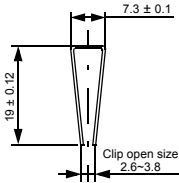
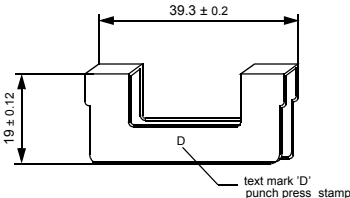
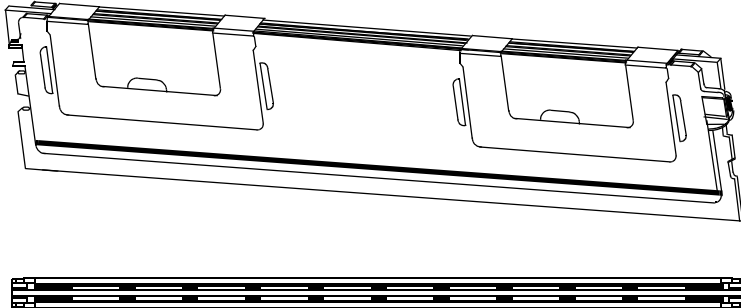
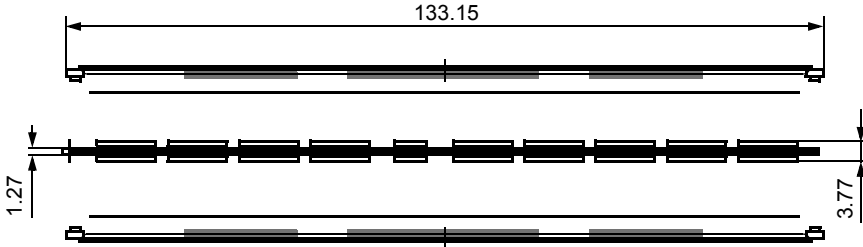

x72 240pin DDR3 SDRAM VLP RDIMM

Units : Millimeters

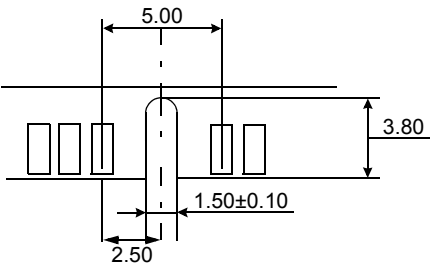
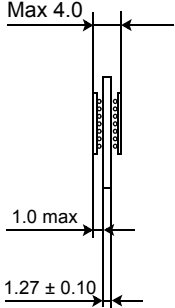
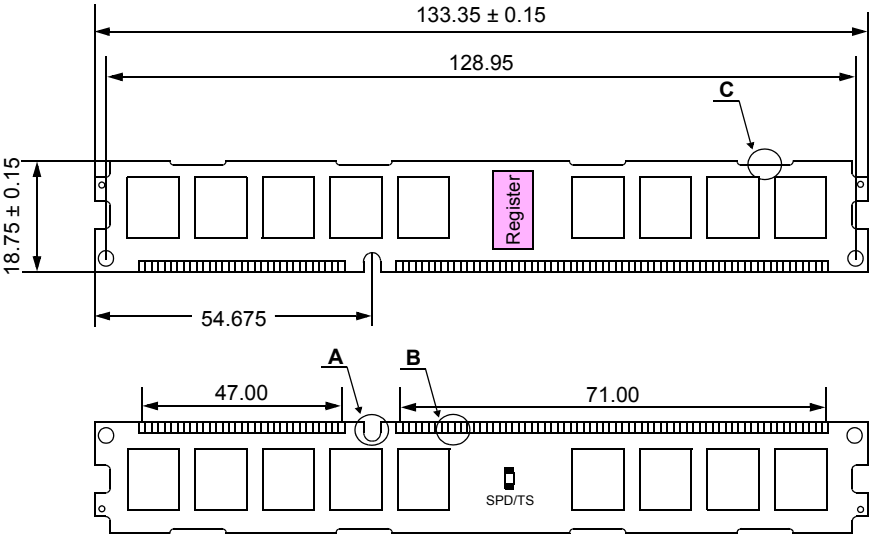

Detail A

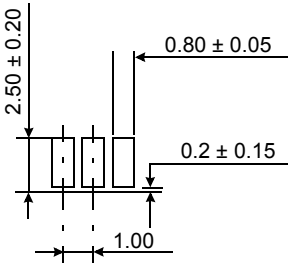

Detail B

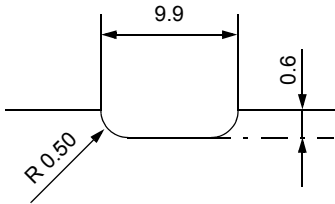

Detail C

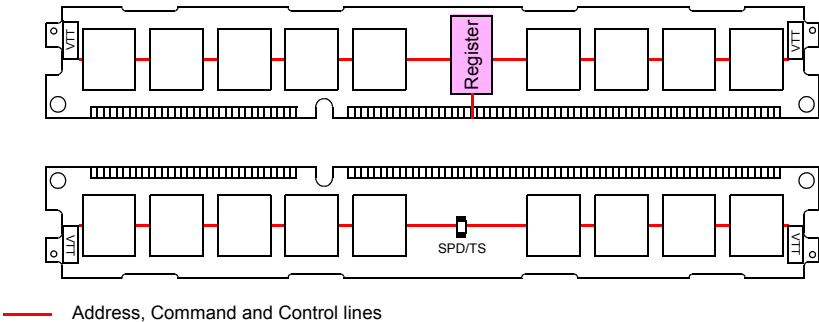

— Address, Command and Control lines

x72 240pin DDR3 SDRAM VLP RDIMM Heat Spreader Design (DDP, QDP)

1. FRONT PART

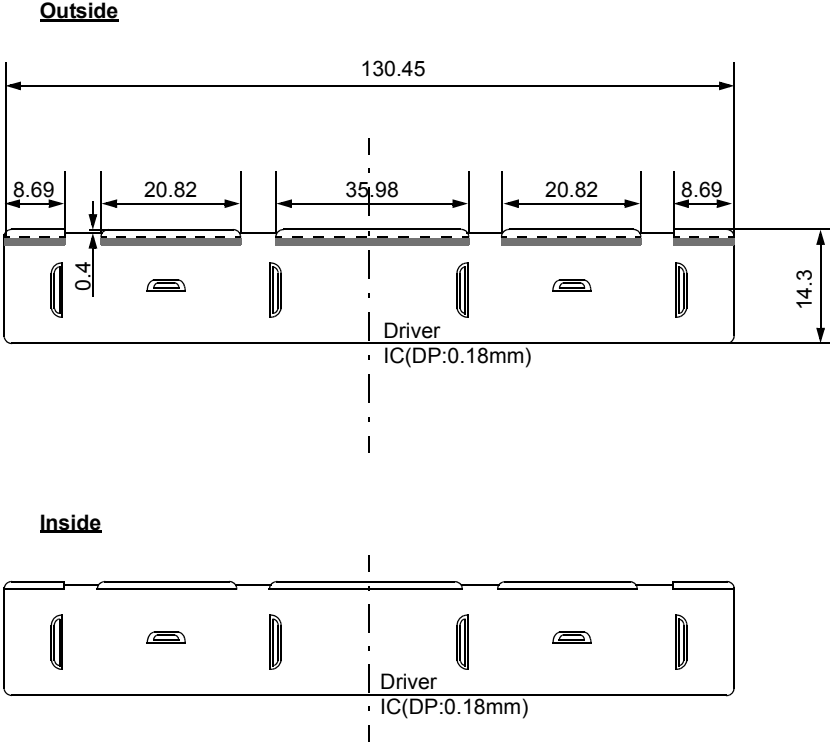

2. BACK PART

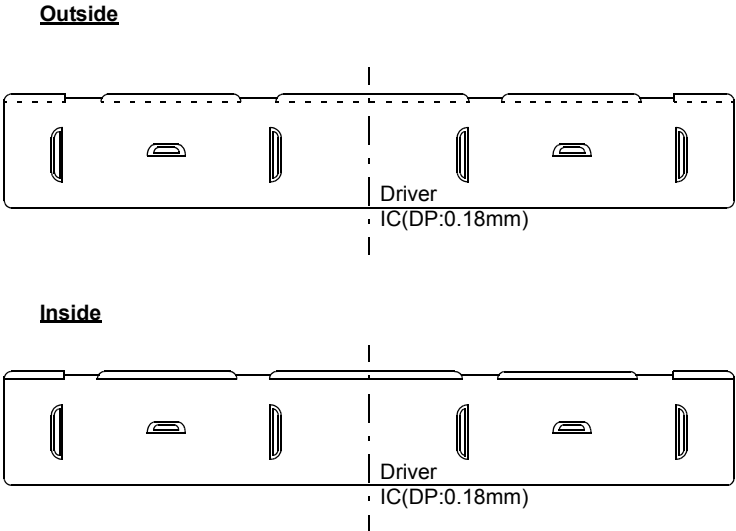

3. CLIP PART

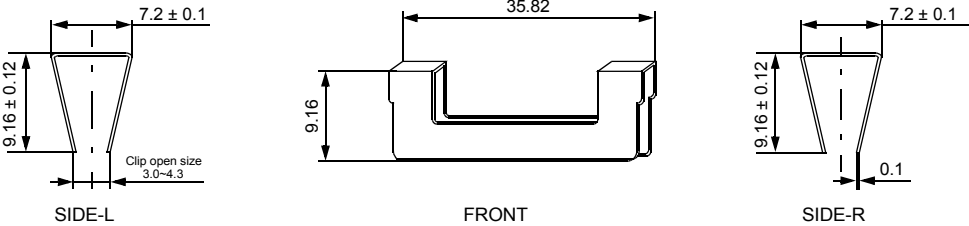

4. ASS'Y VIEW

Reference thickness total (Maximum) : 7.55 (With Clip thickness)

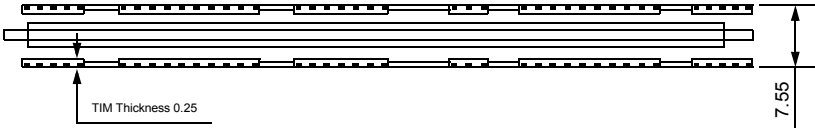

x72 204 pin DDR3 SDRAM ECC SODIMM
x64 204pin DDR3 SDRAM Non ECC SODIMM

Units : Millimeters

