

# NCP511, NCV511

## Voltage Regulator - CMOS, Low Iq, Low-Dropout

### 150 mA

The NCP511 series of fixed output low dropout linear regulators are designed for handheld communication equipment and portable battery powered applications which require low quiescent current. The NCP511 series features an ultra-low quiescent current of 40  $\mu$ A. Each device contains a voltage reference unit, an error amplifier, a PMOS power transistor, resistors for setting output voltage, current limit, and temperature limit protection circuits.

The NCP511 has been designed to be used with low cost ceramic capacitors and requires a minimum output capacitor of 1.0  $\mu$ F. The device is housed in the micro-miniature TSOP-5 surface mount package. Standard voltage versions are 1.5 V, 1.8 V, 2.5 V, 2.7 V, 2.8 V, 3.0 V, 3.3 V, and 5.0 V. Other voltages are available in 100 mV steps.

#### Features

- Low Quiescent Current of 40  $\mu$ A Typical
- Low Dropout Voltage of 100 mV at 100 mA
- Excellent Line and Load Regulation
- Maximum Operating Voltage of 6.0 V
- Low Output Voltage Option
- High Accuracy Output Voltage of 2.0%
- Industrial Temperature Range of  $-40^{\circ}\text{C}$  to  $85^{\circ}\text{C}$
- NCV Prefix for Automotive and Other Applications Requiring Unique Site and Control Change Requirements; AEC-Q100 Qualified and PPAP Capable
- These are Pb-Free Devices

#### Typical Applications

- Cellular Phones
- Battery Powered Instruments
- Hand-Held Instruments
- Camcorders and Cameras

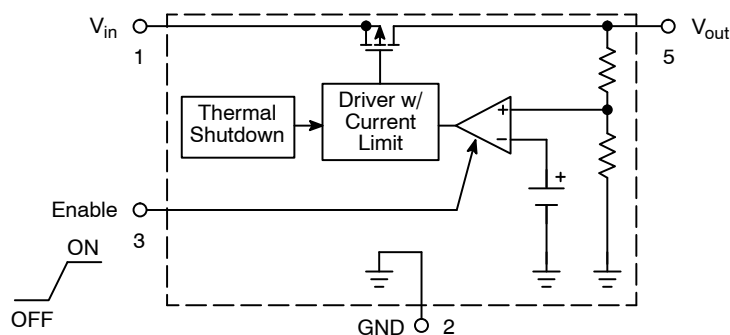

This device contains 82 active transistors

Figure 1. Representative Block Diagram



ON Semiconductor®

[www.onsemi.com](http://www.onsemi.com)

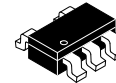

TSOP-5  
SN SUFFIX  
CASE 483

#### PIN CONNECTIONS AND MARKING DIAGRAM

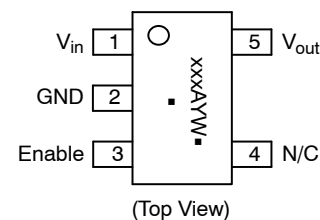

xxx = Specific Device Code  
A = Assembly Location  
Y = Year  
W = Work Week  
▪ = Pb-Free Package

(Note: Microdot may be in either location)

#### ORDERING INFORMATION

See detailed ordering and shipping information in the package dimensions section on page 10 of this data sheet.

# NCP511, NCV511

## PIN FUNCTION DESCRIPTION

| Pin No. | Pin Name  | Description  |
|---------|-----------|--|
| 1       | $V_{in}$  | Positive power supply input voltage.   |
| 2       | GND       | Power supply ground.   |
| 3       | Enable    | This input is used to place the device into low-power standby. When this input is pulled low, the device is disabled. If this function is not used, Enable should be connected to $V_{in}$ . |
| 4       | N/C       | No internal connection.  |
| 5       | $V_{out}$ | Regulated output voltage.  |

## MAXIMUM RATINGS

| Rating  | Symbol                   | Value                     | Unit      |
|---|--------------------------|---------------------------|-----------|
| Input Voltage   | $V_{in}$                 | 0 to 6.0                  | V         |
| Enable Voltage  | Enable                   | -0.3 to $V_{in} + 0.3$    | V         |
| Output Voltage  | $V_{out}$                | -0.3 to $V_{in} + 0.3$    | V         |
| Power Dissipation and Thermal Characteristics<br>Power Dissipation<br>Thermal Resistance, Junction to Ambient | $P_D$<br>$R_{\theta JA}$ | Internally Limited<br>250 | W<br>°C/W |
| Operating Junction Temperature  | $T_J$                    | +150                      | °C        |
| Operating Ambient Temperature   | $T_A$                    | -40 to +85                | °C        |
| Storage Temperature   | $T_{stg}$                | -55 to +150               | °C        |

Stresses exceeding those listed in the Maximum Ratings table may damage the device. If any of these limits are exceeded, device functionality should not be assumed, damage may occur and reliability may be affected.

1. This device series contains ESD protection and exceeds the following tests:

Human Body Model 2000 V per MIL-STD-883, Method 3015

Machine Model Method 200 V

2. Latch up capability (85°C)  $\pm 100$  mA DC with trigger voltage.

# NCP511, NCV511

## ELECTRICAL CHARACTERISTICS

( $V_{in} = V_{out(nom.)} + 1.0$  V,  $V_{enable} = V_{in}$ ,  $C_{in} = 1.0$   $\mu$ F,  $C_{out} = 1.0$   $\mu$ F,  $T_J = 25^\circ$ C, unless otherwise noted.)

| Characteristic   | Symbol             | Min  | Typ  | Max   | Unit                   |
|--|--------------------|--|--|---|------------------------|
| Output Voltage ( $T_A = 25^\circ$ C, $I_{out} = 1.0$ mA)<br>1.5 V<br>1.8 V<br>2.5 V<br>2.7 V<br>2.8 V<br>3.0 V<br>3.3 V<br>5.0 V   | $V_{out}$          | 1.455<br>1.746<br>2.425<br>2.646<br>2.744<br>2.94<br>3.234<br>4.900  | 1.5<br>1.8<br>2.5<br>2.7<br>2.8<br>3.0<br>3.3<br>5.0 | 1.545<br>1.854<br>2.575<br>2.754<br>2.856<br>3.06<br>3.366<br>5.100 | V                      |
| Output Voltage ( $T_A = -40^\circ$ C to $85^\circ$ C, $I_{out} = 1.0$ mA)<br>1.5 V<br>1.8 V<br>2.5 V<br>2.7 V<br>2.8 V<br>3.0 V<br>3.3 V<br>5.0 V  | $V_{out}$          | 1.455<br>1.746<br>2.425<br>2.619<br>2.716<br>2.910<br>3.201<br>4.900 | 1.5<br>1.8<br>2.5<br>2.7<br>2.8<br>3.0<br>3.3<br>5.0 | 1.545<br>1.854<br>2.575<br>2.781<br>2.884<br>3.09<br>3.399<br>5.100 | V                      |
| Line Regulation ( $I_{out} = 10$ mA)<br>1.5 V–4.4 V ( $V_{in} = V_{out(nom.)} + 1.0$ V to 6.0 V)<br>4.5 V–5.0 V ( $V_{in} = 5.5$ V to 6.0 V)   | $Reg_{line}$       | –<br>–   | 1.0<br>1.0   | 3.5<br>3.5  | mV/V                   |
| Load Regulation ( $I_{out} = 1.0$ mA to 150 mA)  | $Reg_{load}$       | –  | 0.3  | 0.8   | mV/mA                  |
| Output Current ( $V_{out} = (V_{out} \text{ at } I_{out} = 150 \text{ mA}) - 3\%$ )<br>1.5 V–1.8 V ( $V_{in} = 4.0$ V)<br>1.9 V–3.0 V ( $V_{in} = 5.0$ V)<br>3.1 V–5.0 V ( $V_{in} = 6.0$ V) | $I_{out(nom.)}$    | 150<br>150<br>150  | –<br>–<br>–  | –<br>–<br>–   | mA                     |
| Dropout Voltage ( $I_{out} = 100$ mA, Measured at $V_{out} - 3.0\%$ )<br>1.5 V<br>1.8 V<br>2.5 V<br>2.7 V<br>2.8 V<br>3.0 V<br>3.3 V<br>5.0 V  | $V_{in} - V_{out}$ | –<br>–<br>–<br>–<br>–<br>–<br>–<br>–                                 | 245<br>160<br>110<br>100<br>100<br>100<br>90<br>75   | 350<br>200<br>200<br>200<br>200<br>200<br>200<br>200                | mV                     |
| Quiescent Current<br>(Enable Input = 0 V)<br>(Enable Input = $V_{in}$ , $I_{out} = 1.0$ mA to $I_{o(nom.)}$ )  | $I_Q$              | –<br>–   | 0.1<br>40  | 1.0<br>100  | $\mu$ A                |
| Output Voltage Temperature Coefficient   | $T_C$              | –  | $\pm 100$  | –   | ppm/ $^\circ$ C        |
| Enable Input Threshold Voltage<br>(Voltage Increasing, Output Turns On, Logic High)<br>(Voltage Decreasing, Output Turns Off, Logic Low)   | $V_{th(en)}$       | 1.3<br>–   | –<br>–   | –<br>0.3  | V                      |
| Output Short Circuit Current ( $V_{out} = 0$ V)<br>1.5 V–1.8 V ( $V_{in} = 4.0$ V)<br>1.9 V–3.0 V ( $V_{in} = 5.0$ V)<br>3.1 V–5.0 V ( $V_{in} = 6.0$ V)                                     | $I_{out(max)}$     | 200<br>200<br>200  | 400<br>400<br>400                                    | 800<br>800<br>800   | mA                     |
| Ripple Rejection ( $f = 1.0$ kHz, $I_o = 60$ mA)   | RR                 | –  | 50   | –   | dB                     |
| Output Noise Voltage ( $f = 20$ Hz to 100 kHz, $I_{out} = 60$ mA)  | $V_n$              | –  | 110  | –   | $\mu$ V <sub>RMS</sub> |

Product parametric performance is indicated in the Electrical Characteristics for the listed test conditions, unless otherwise noted. Product performance may not be indicated by the Electrical Characteristics if operated under different conditions.

3. Maximum package power dissipation limits must be observed.

$$PD = \frac{T_J(max) - T_A}{R_{\theta JA}}$$

4. Low duty cycle pulse techniques are used during testing to maintain the junction temperature as close to ambient as possible.

# NCP511, NCV511

## TYPICAL CHARACTERISTICS

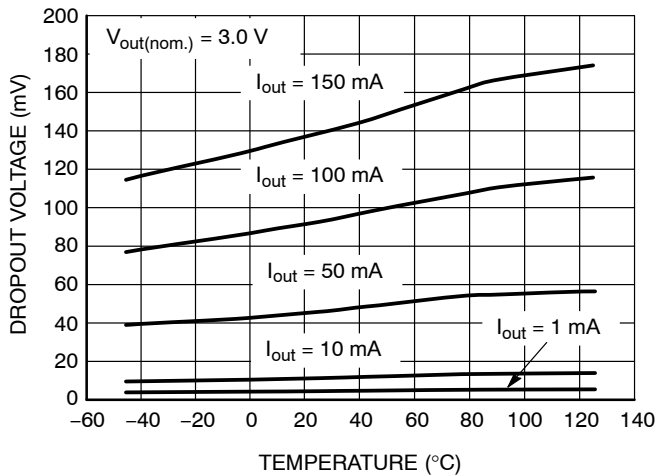

Figure 2. Dropout Voltage vs. Temperature

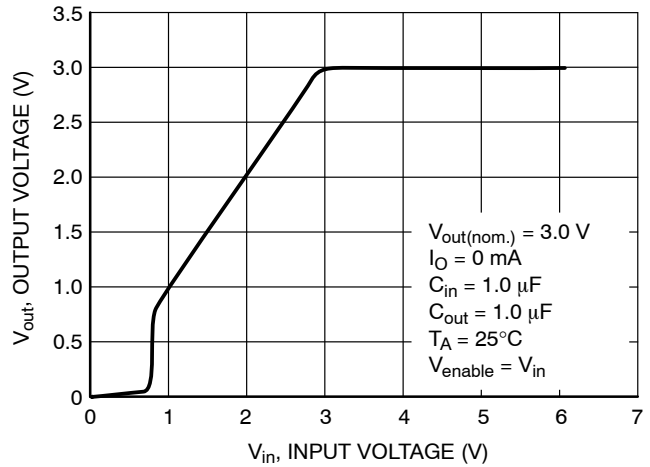

Figure 3. Output Voltage vs. Input Voltage

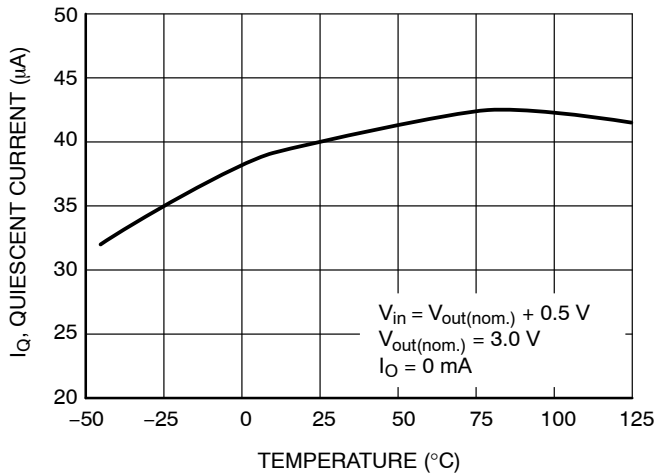

Figure 4. Quiescent Current vs. Temperature

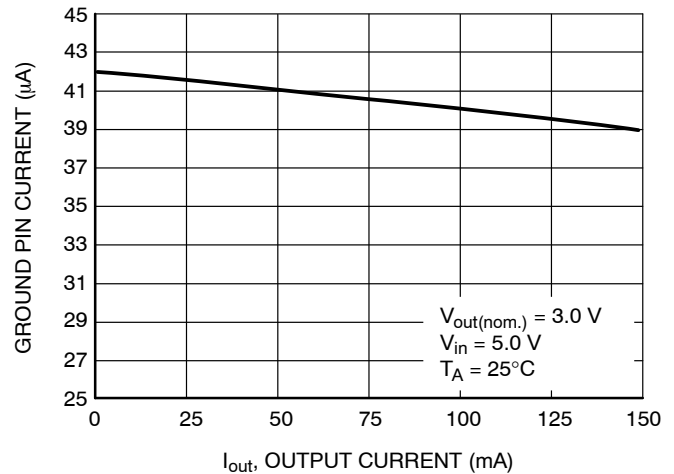

Figure 5. Ground Pin Current vs. Output Current

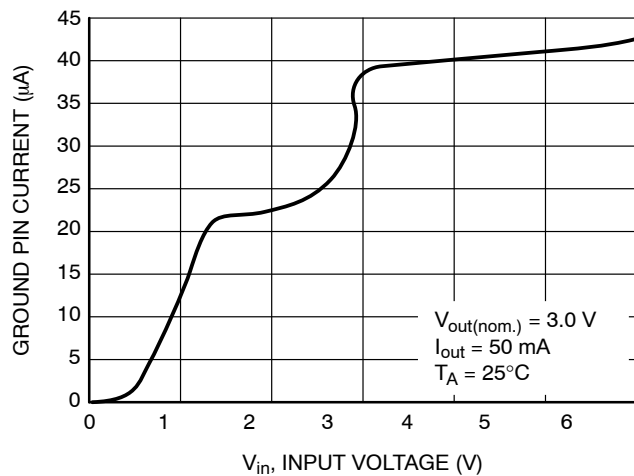

Figure 6. Ground Pin Current vs. Input Voltage

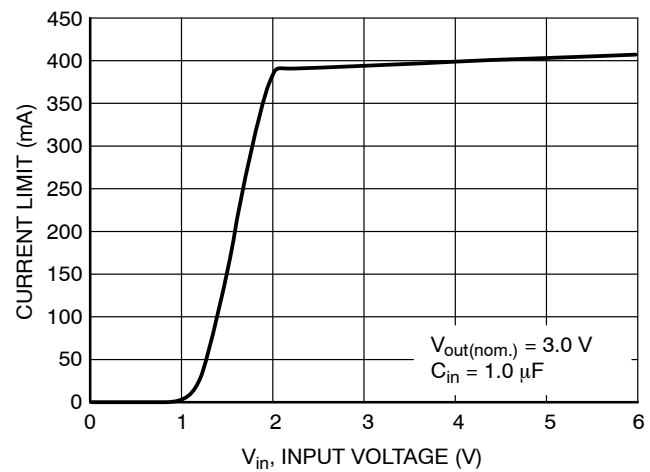

Figure 7. Current Limit vs. Input Voltage

# NCP511, NCV511

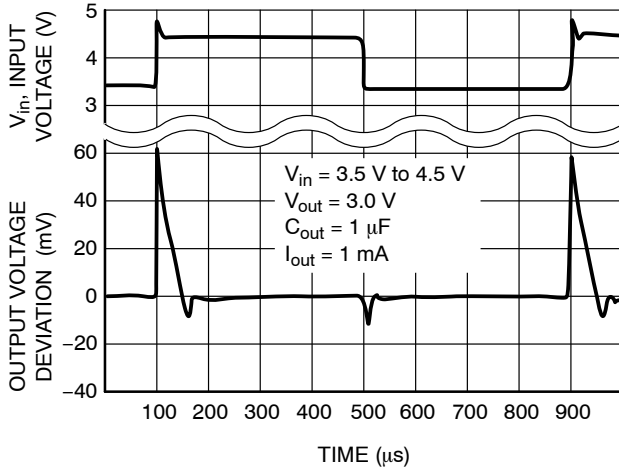

Figure 8. Line Transient Response

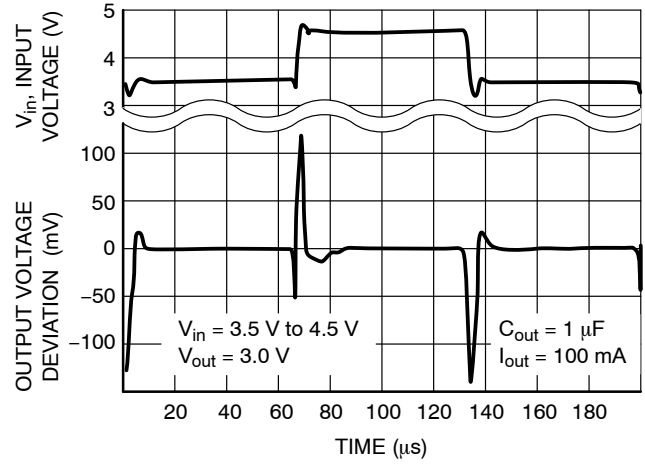

Figure 9. Line Transient Response

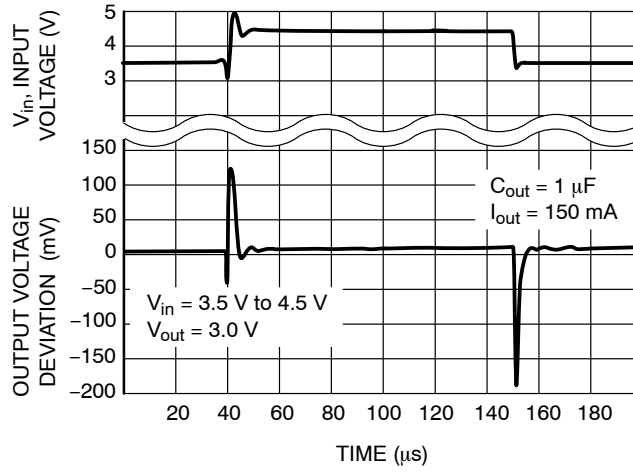

Figure 10. Line Transient Response

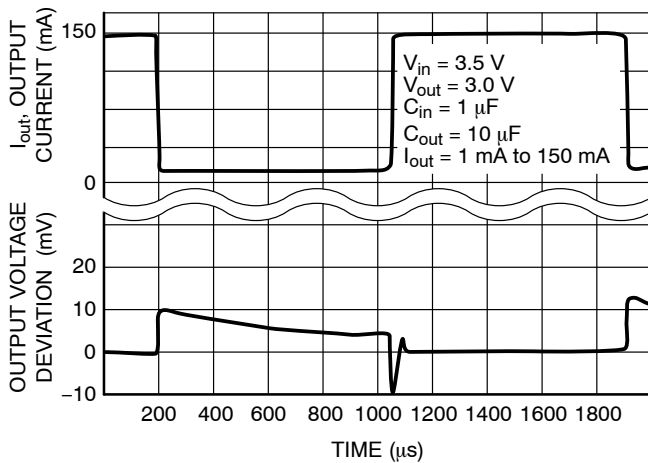

Figure 11. Load Transient Response

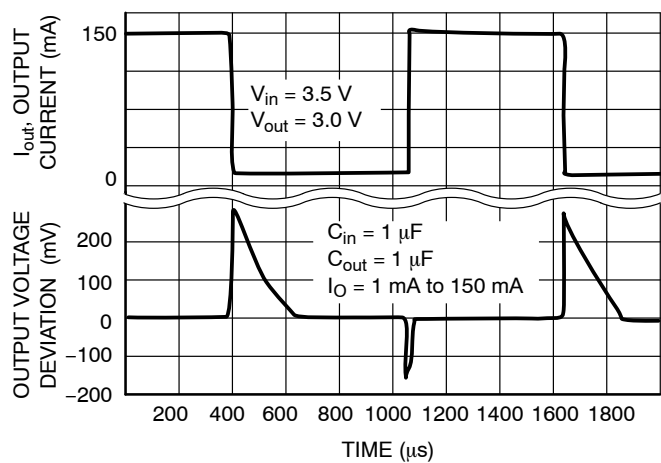
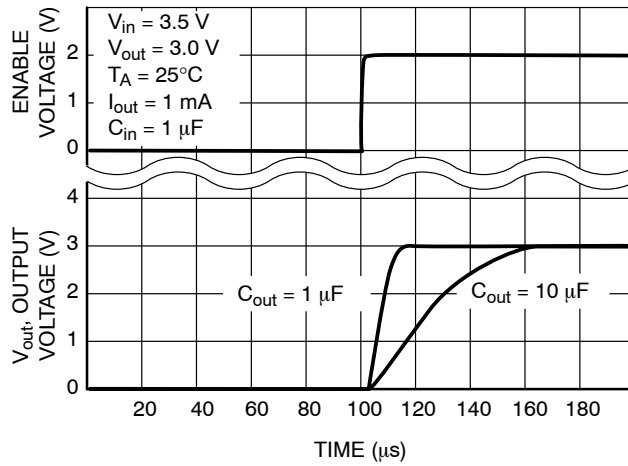
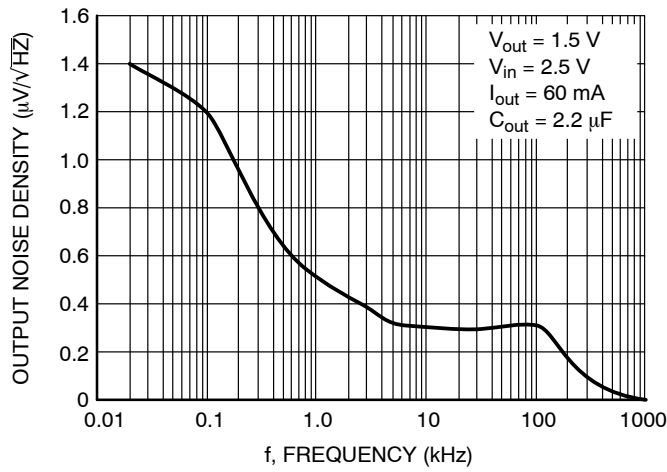

Figure 12. Load Transient Response

# NCP511, NCV511



**Figure 13. Turn-On Response**



**Figure 14. Output Noise Density**

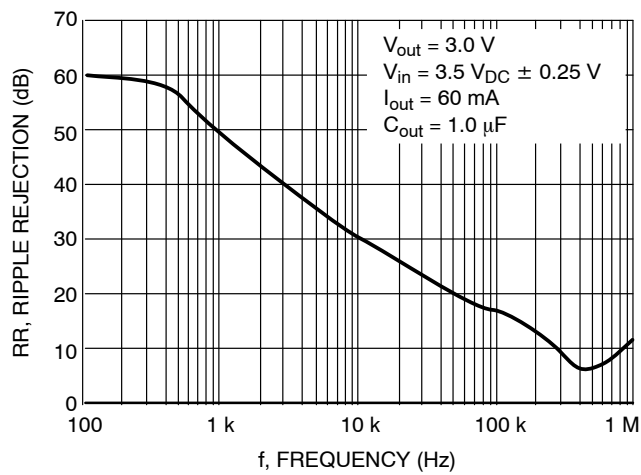

**Figure 15. Ripple Rejection vs. Frequency**

## DEFINITIONS

### Load Regulation

The change in output voltage for a change in output current at a constant temperature.

### Dropout Voltage

The input/output differential at which the regulator output no longer maintains regulation against further reductions in input voltage. Measured when the output drops 3.0% below its nominal. The junction temperature, load current, and minimum input supply requirements affect the dropout level.

### Maximum Power Dissipation

The maximum total dissipation for which the regulator will operate within its specifications.

### Quiescent Current

The quiescent current is the current which flows through the ground when the LDO operates without a load on its output: internal IC operation, bias, etc. When the LDO becomes loaded, this term is called the Ground current. It is actually the difference between the input current (measured through the LDO input pin) and the output current.

### Line Regulation

The change in output voltage for a change in input voltage. The measurement is made under conditions of low dissipation or by using pulse technique such that the average chip temperature is not significantly affected.

### Line Transient Response

Typical over and undershoot response when input voltage is excited with a given slope.

### Thermal Protection

Internal thermal shutdown circuitry is provided to protect the integrated circuit in the event that the maximum junction temperature is exceeded. When activated at typically 160°C, the regulator turns off. This feature is provided to prevent failures from accidental overheating.

### Maximum Package Power Dissipation

The maximum power package dissipation is the power dissipation level at which the junction temperature reaches its maximum operating value, i.e. 125°C. Depending on the ambient power dissipation and thus the maximum available output current.

# NCP511, NCV511

## APPLICATIONS INFORMATION

A typical application circuit for the NCP511 series is shown in Figure 16.

### Input Decoupling (C1)

A 1.0  $\mu\text{F}$  capacitor either ceramic or tantalum is recommended and should be connected close to the NCP511 package. Higher values and lower ESR will improve the overall line transient response.

### Output Decoupling (C2)

The NCP511 is a stable Regulator and does not require any specific Equivalent Series Resistance (ESR) or a minimum output current. Capacitors exhibiting ESRs ranging from a few  $\text{m}\Omega$  up to  $3.0 \Omega$  can thus safely be used. The minimum decoupling value is 1.0  $\mu\text{F}$  and can be augmented to fulfill stringent load transient requirements. The regulator accepts ceramic chip capacitors as well as tantalum devices. Larger values improve noise rejection and load regulation transient response.

### Enable Operation

The enable pin will turn on or off the regulator. These limits of threshold are covered in the electrical specification section of this data sheet. If the enable is not used then the pin should be connected to  $V_{\text{in}}$ .

### Hints

Please be sure the  $V_{\text{in}}$  and GND lines are sufficiently wide. When the impedance of these lines is high, there is a chance to pick up noise or cause the regulator to malfunction.

Set external components, especially the output capacitor, as close as possible to the circuit, and make leads as short as possible.

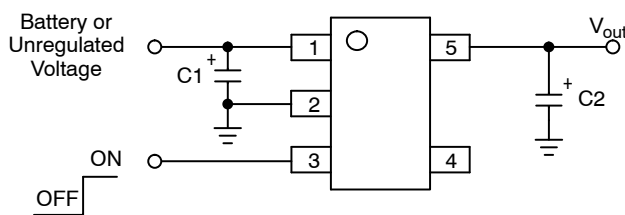

Figure 16. Typical Application Circuit

### Thermal

As power across the NCP511 increases, it might become necessary to provide some thermal relief. The maximum power dissipation supported by the device is dependent upon board design and layout. Mounting pad configuration on the PCB, the board material and also the ambient temperature effect the rate of temperature rise for the part. This is stating that when the NCP511 has good thermal conductivity through the PCB, the junction temperature will be relatively low with high power dissipation applications.

The maximum dissipation the package can handle is given by:

$$P_D = \frac{T_{J(\text{max})} - T_A}{R_{\theta JA}}$$

If junction temperature is not allowed above the maximum  $125^\circ\text{C}$ , then the NCP511 can dissipate up to 400  $\text{mW}$  @  $25^\circ\text{C}$ .

The power dissipated by the NCP511 can be calculated from the following equation:

$$P_{\text{tot}} = [V_{\text{in}} * I_{\text{gnd}}(\text{out})] + [V_{\text{in}} - V_{\text{out}}] * I_{\text{out}}$$

or

$$V_{\text{inMAX}} = \frac{P_{\text{tot}} + V_{\text{out}} * I_{\text{out}}}{I_{\text{gnd}} + I_{\text{out}}}$$

If a 150  $\text{mA}$  output current is needed then the ground current from the data sheet is  $40 \mu\text{A}$ . For an NCP511SN30T1 (3.0  $\text{V}$ ), the maximum input voltage will then be 5.6  $\text{V}$ .

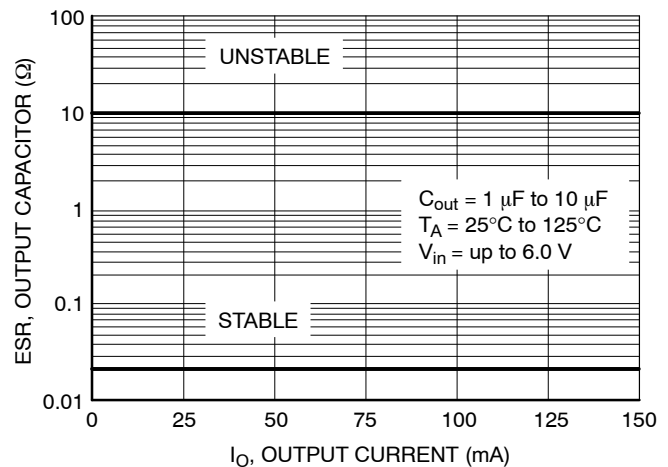
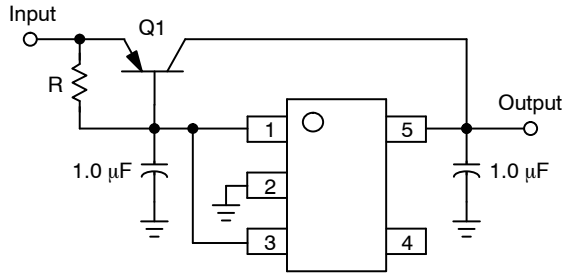

Figure 17. Output Capacitor vs. Output Current



# NCP511, NCV511

## APPLICATION CIRCUITS



**Figure 18. Current Boost Regulator**

The NCP511 series can be current boosted with a PNP transistor. Resistor R in conjunction with  $V_{BE}$  of the PNP determines when the pass transistor begins conducting; this circuit is not short circuit proof. Input/Output differential voltage minimum is increased by  $V_{BE}$  of the pass resistor.

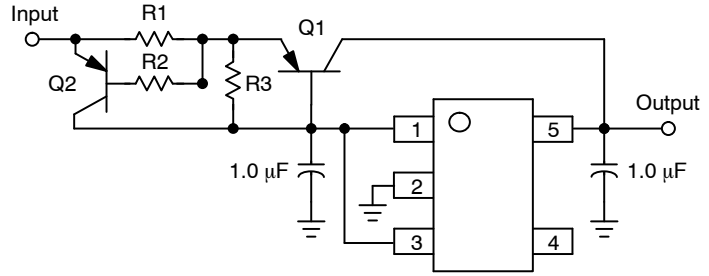

**Figure 19. Current Boost Regulator with Short Circuit Limit**

Short circuit current limit is essentially set by the  $V_{BE}$  of Q2 and R1.  $I_{SC} = ((V_{BEQ2} - i_b * R2) / R1) + I_{O(max)} \text{ Regulator}$

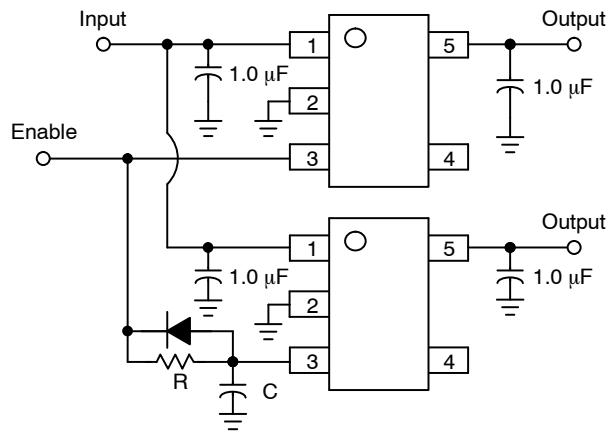

**Figure 20. Delayed Turn-on**

If a delayed turn-on is needed during power up of several voltages then the above schematic can be used. Resistor R, and capacitor C, will delay the turn-on of the bottom regulator. A few values were chosen and the resulting delay can be seen in Figure 21.

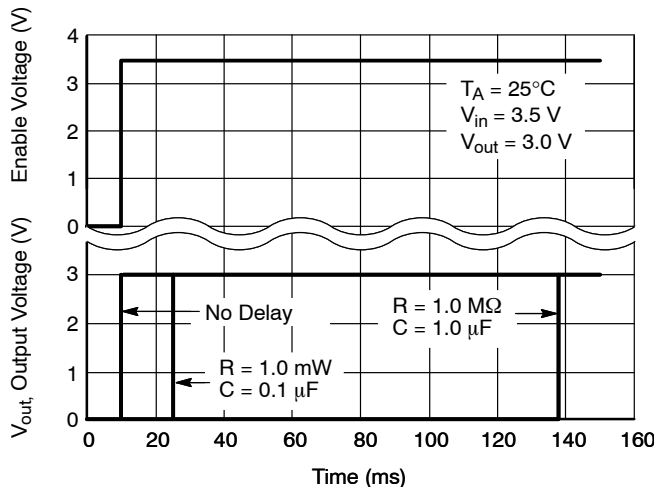

**Figure 21. Delayed Turn-on**

The graph shows the delay between the enable signal and output turn-on for various resistor and capacitor values.

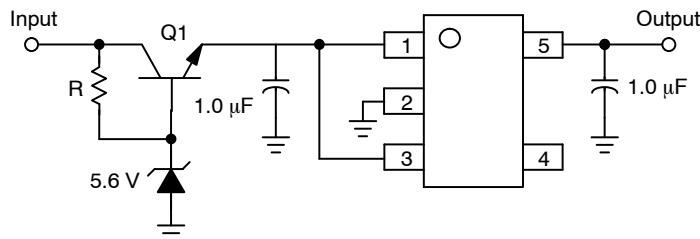

**Figure 22. Input Voltages Greater than 6.0 V**

A regulated output can be achieved with input voltages that exceed the 6.0 V maximum rating of the NCP511 series with the addition of a simple pre-regulator circuit. Care must be taken to prevent Q1 from overheating when the regulated output ( $V_{out}$ ) is shorted to GND.

# NCP511, NCV511

## ORDERING INFORMATION

| Device        | Nominal Output Voltage | Marking | Package | Shipping <sup>†</sup>         |
|---------------|------------------------|---------|---------|-------------------------------|
| NCP511SN15T1G | 1.5                    | LBU     | TSOP-5  | 3000 Units/<br>7" Tape & Reel |
| NCP511SN18T1G | 1.8                    | LBV     |         |                               |
| NCP511SN25T1G | 2.5                    | LBW     |         |                               |
| NCP511SN27T1G | 2.7                    | LBX     |         |                               |
| NCP511SN28T1G | 2.8                    | LBY     |         |                               |
| NCP511SN30T1G | 3.0                    | LBZ     |         |                               |
| NCP511SN33T1G | 3.3                    | LCA     |         |                               |
| NCP511SN50T1G | 5.0                    | LCB     |         |                               |
| NCV511SN15T1G | 1.5                    | LBU     |         |                               |
| NCV511SN25T1G | 2.5                    | LBW     |         |                               |

<sup>†</sup>For information on tape and reel specifications, including part orientation and tape sizes, please refer to our Tape and Reel Packaging Specifications Brochure, BRD8011/D.

NOTE: Additional voltages in 100 mV steps are available upon request by contacting your ON Semiconductor representative.

# MECHANICAL CASE OUTLINE PACKAGE DIMENSIONS

ON Semiconductor®



SCALE 2:1

## TSOP-5 CASE 483 ISSUE N

DATE 12 AUG 2020



NOTES:

1. DIMENSIONING AND TOLERANCING PER ASME Y14.5M, 1994.
2. CONTROLLING DIMENSION: MILLIMETERS.
3. MAXIMUM LEAD THICKNESS INCLUDES LEAD FINISH THICKNESS. MINIMUM LEAD THICKNESS IS THE MINIMUM THICKNESS OF BASE MATERIAL.
4. DIMENSIONS A AND B DO NOT INCLUDE MOLD FLASH, PROTRUSIONS, OR GATE BURRS. MOLD FLASH, PROTRUSIONS, OR GATE BURRS SHALL NOT EXCEED 0.15 PER SIDE. DIMENSION A.
5. OPTIONAL CONSTRUCTION: AN ADDITIONAL TRIMMED LEAD IS ALLOWED IN THIS LOCATION. TRIMMED LEAD NOT TO EXTEND MORE THAN 0.2 FROM BODY.

| DIM | MILLIMETERS |      |
|-----|-------------|------|
|     | MIN         | MAX  |
| A   | 2.85        | 3.15 |
| B   | 1.35        | 1.65 |
| C   | 0.90        | 1.10 |
| D   | 0.25        | 0.50 |
| G   | 0.95 BSC    |      |
| H   | 0.01        | 0.10 |
| J   | 0.10        | 0.26 |
| K   | 0.20        | 0.60 |
| M   | 0°          | 10°  |
| S   | 2.50        | 3.00 |

### SOLDERING FOOTPRINT\*



\*For additional information on our Pb-Free strategy and soldering details, please download the ON Semiconductor Soldering and Mounting Techniques Reference Manual, SOLDERRM/D.

### GENERIC MARKING DIAGRAM\*



- XXX = Specific Device Code    XXX = Specific Device Code  
 A = Assembly Location        M = Date Code  
 Y = Year                            ▪ = Pb-Free Package  
 W = Work Week  
 ▪ = Pb-Free Package

(Note: Microdot may be in either location)

\*This information is generic. Please refer to device data sheet for actual part marking. Pb-Free indicator, "G" or microdot "▪", may or may not be present.

|                  |             |  |
|------------------|-------------|--|
| DOCUMENT NUMBER: | 98ARB18753C | Electronic versions are uncontrolled except when accessed directly from the Document Repository. Printed versions are uncontrolled except when stamped "CONTROLLED COPY" in red. |
| DESCRIPTION:     | TSOP-5      | PAGE 1 OF 1  |

ON Semiconductor and ON are trademarks of Semiconductor Components Industries, LLC dba ON Semiconductor or its subsidiaries in the United States and/or other countries. ON Semiconductor reserves the right to make changes without further notice to any products herein. ON Semiconductor makes no warranty, representation or guarantee regarding the suitability of its products for any particular purpose, nor does ON Semiconductor assume any liability arising out of the application or use of any product or circuit, and specifically disclaims any and all liability, including without limitation special, consequential or incidental damages. ON Semiconductor does not convey any license under its patent rights nor the rights of others.

**onsemi**, **Onsemi**, and other names, marks, and brands are registered and/or common law trademarks of Semiconductor Components Industries, LLC dba "**onsemi**" or its affiliates and/or subsidiaries in the United States and/or other countries. **onsemi** owns the rights to a number of patents, trademarks, copyrights, trade secrets, and other intellectual property. A listing of **onsemi**'s product/patent coverage may be accessed at [www.onsemi.com/site/pdf/Patent-Marking.pdf](http://www.onsemi.com/site/pdf/Patent-Marking.pdf). **onsemi** reserves the right to make changes at any time to any products or information herein, without notice. The information herein is provided "as-is" and **onsemi** makes no warranty, representation or guarantee regarding the accuracy of the information, product features, availability, functionality, or suitability of its products for any particular purpose, nor does **onsemi** assume any liability arising out of the application or use of any product or circuit, and specifically disclaims any and all liability, including without limitation special, consequential or incidental damages. Buyer is responsible for its products and applications using **onsemi** products, including compliance with all laws, regulations and safety requirements or standards, regardless of any support or applications information provided by **onsemi**. "Typical" parameters which may be provided in **onsemi** data sheets and/or specifications can and do vary in different applications and actual performance may vary over time. All operating parameters, including "Typicals" must be validated for each customer application by customer's technical experts. **onsemi** does not convey any license under any of its intellectual property rights nor the rights of others. **onsemi** products are not designed, intended, or authorized for use as a critical component in life support systems or any FDA Class 3 medical devices or medical devices with a same or similar classification in a foreign jurisdiction or any devices intended for implantation in the human body. Should Buyer purchase or use **onsemi** products for any such unintended or unauthorized application, Buyer shall indemnify and hold **onsemi** and its officers, employees, subsidiaries, affiliates, and distributors harmless against all claims, costs, damages, and expenses, and reasonable attorney fees arising out of, directly or indirectly, any claim of personal injury or death associated with such unintended or unauthorized use, even if such claim alleges that **onsemi** was negligent regarding the design or manufacture of the part. **onsemi** is an Equal Opportunity/Affirmative Action Employer. This literature is subject to all applicable copyright laws and is not for resale in any manner.

## PUBLICATION ORDERING INFORMATION

### LITERATURE FULFILLMENT:

Email Requests to: [orderlit@onsemi.com](mailto:orderlit@onsemi.com)

**onsemi Website:** [www.onsemi.com](http://www.onsemi.com)

### TECHNICAL SUPPORT

**North American Technical Support:**

Voice Mail: 1 800-282-9855 Toll Free USA/Canada

Phone: 011 421 33 790 2910

**Europe, Middle East and Africa Technical Support:**

Phone: 00421 33 790 2910

For additional information, please contact your local Sales Representative

