

## LED Module

# LAM-RT30

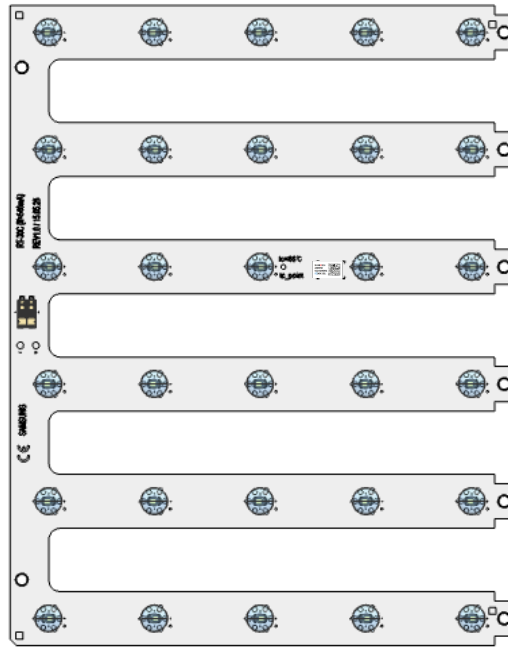

### Features & Benefits

- Easy connection with re-workable poke-in connector
- Fit better to replace conventional T5, T8 fixture with narrow width
- Full Certifications

### Applications

#### Indoor Lighting:

- Office / Retail / Living space
- Area Panels, Troffer and Linear Pendants
- Channel and Cove lighting



**SAMSUNG**

## Table of Contents

1.	Product Code Information	-----	3
2.	Characteristics	-----	4
3.	Structure and Assembly	-----	6
4.	Certification and Declaration	-----	9
5.	Label Structure	-----	10
6.	Packing Structure	-----	11
7.	Precautions in Handling & Use	-----	12
APPENDIX 1.	Tc vs Lifetime	-----	13
APPENDIX 2.	If vs Luminous Flux	-----	14
APPENDIX 3.	If vs Efficiency	-----	14

## 1. Product Code Information

Nominal CCT (K)	Front CNT	Product Code
3000		SI-B8V116280WW
4000	Front CNT	SI-B8T116280WW
6500		SI-B8P116280WW

**SAMSUNG**

## 2. Characteristics

Item	Rating	Unit	Remark
Rated Lifetime	>50,000	hour	L70B50
Ingress Protection (IP)	no rating	-	
Ambient / Operating Temperature ( $t_{amb}$ )	-20 ~ +50	°C	
Storage Temperature	-30 ~ +80	°C	

Item	Nom. CCT (K)	Rating			Unit	Remark
		Min	Typ.	Max		
Luminous Flux ( $\Phi_v$ )	3000	1301	1445	1606	lm	
	4000	1364	1515	1683		
	6500	1364	1515	1683		
Luminous Efficacy	3000	123	137	152	lm/W	
	4000	129	143	159		
	6500	129	143	159		
CCT	3000	-	3007	-	K	$I_f = 350 \text{ mA}$ $t_p = 50 \text{ }^\circ\text{C}$
	4000	-	3914	-		
	6500	-	6402	-		
Color Consistency (initial)	3000	-	-	-	Mac Adam 5 step	
	4000	-	-	-	Mac Adam 4 step	
	6500	-	-	-	Mac Adam 5 step	
Color Rendering Index (Ra)		80	83	-	-	
Operating Current ( $I_f$ )		-	350	540	mA	-
Operating Voltage ( $V_f$ )		27.8	30.2	32.8	Vdc	$I_f = 350 \text{ mA}$
Power Consumption		9.7	10.6	11.5	W	$t_p = 50 \text{ }^\circ\text{C}$

### Notes:

- $t_p$ : temperature at which performance is specified; measured at "Tc point".
- Samsung maintains a measurement tolerance of: Luminous flux:  $\pm 7 \%$ , CRI:  $\pm 3.0$ , Voltage:  $\pm 0.3 \text{ V}$ , Power Consumption:  $\pm 0.3 \text{ W}$

Item	Nominal*	Life**	Max***	Unit
Temperature	50 ( $t_p$ )	80( $t_{p,50}$ )	85( $t_c$ )	°C

**Notes:**

- \* Temperature used to specify performance of the module ( $t_p$ ).
- \*\* Rated maximum performance temperature at which lifetime is specified ( $t_{p,50}$ ).
- \*\*\* Rated maximum temperature, highest permissible temperature to avoid safety risk ( $t_c$ ).

All temperatures are measured at the designated “Tc point” as indicated on the module.

### 3. Structure and Assembly

#### a) Appearance

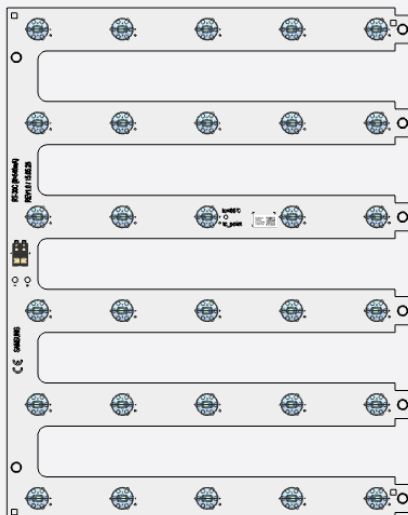

#### b) Dimension

Dimension	Specification	Tolerance	Unit
Module Length	273	±0.4	mm
Module Width	216	±0.4	mm
Module Height	6.6	±0.3	mm
PCB Thickness	1.6	±0.16	mm
Module Weight	97	±4.9	g

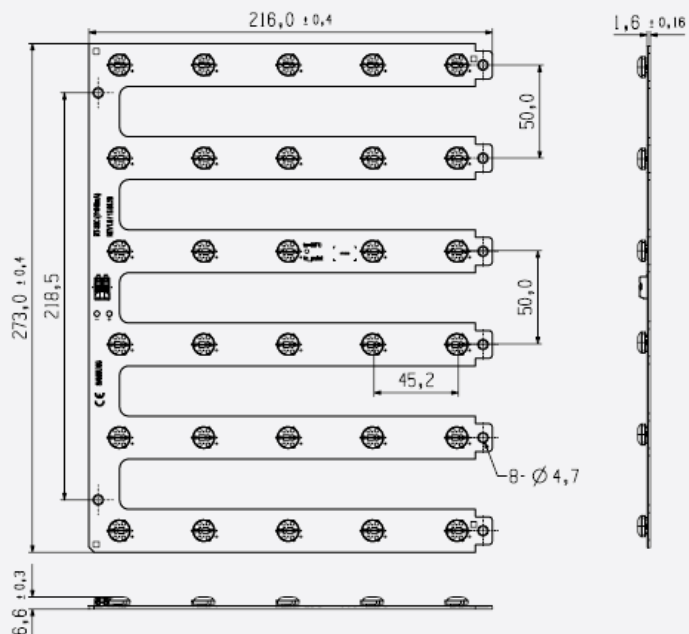

**SAMSUNG**

### c) Assembly

Connectors on the board are provided for easy wiring with the LED driver and between modules

[Front connector]

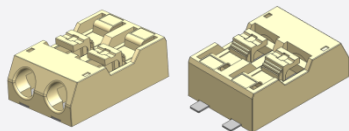

### d) Structure

Item	Specification
LED	LM561B+ Middle Power LED
PCB	Material: copper, solder mask, epoxy
LENS	Dimension : $\varnothing$ 11.56 x 4.99 [mm]
Connector	Reworkable poke-in connector type
Wire	24~18 AWG; terminal strip length of 7.5~8.5 mm

### e) Light Distribution

Polar Intensity Diagram: Beam Angle  $145 \pm 5^\circ$

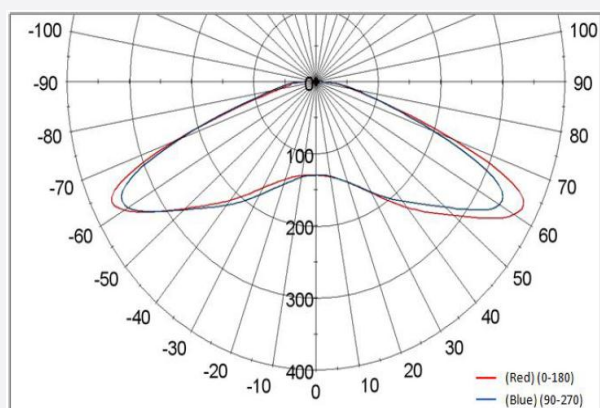

**SAMSUNG**

## f) Thermal Management

Performance temperatures are measured on “tc point” as indicated on the module.

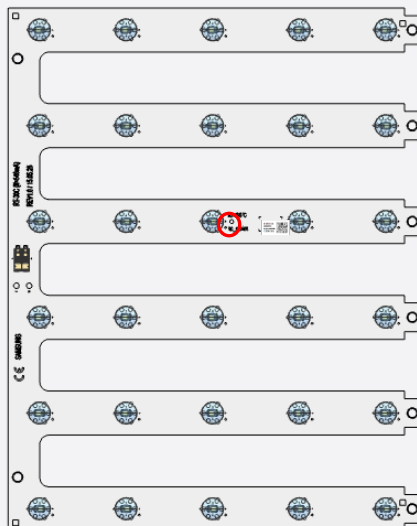

## g) Schematic Circuit

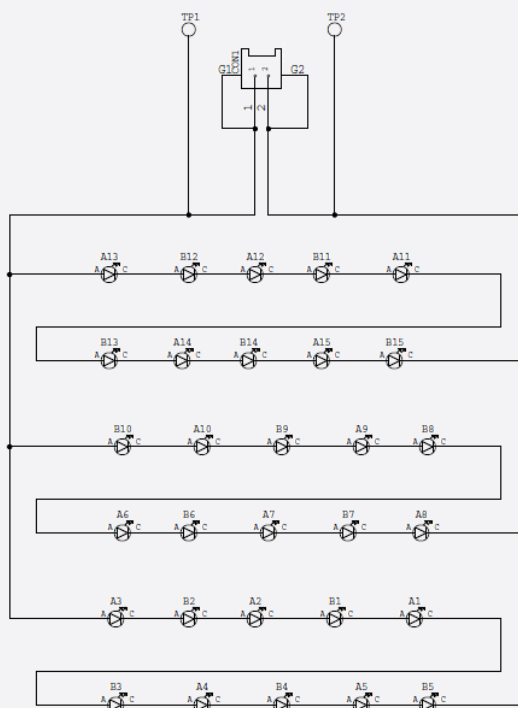

**SAMSUNG**



#### 4. Certification and Declaration

Item	Compliant to	Remark
Test & Certification	CE	IEC / EN 62031, IEC / EN 62471
	ENEC	-
	VDE	-
	UL	-
	cUL	-
	Photo biological Safety(LM561B+ LED)	IEC / EN 62471
Declaration	RoHS	Hazardous Substance & Material
	REACH	Hazardous Substance & Material

**SAMSUNG**

## 5. Label Structure

### a) Module Label

[ Printing Label ]

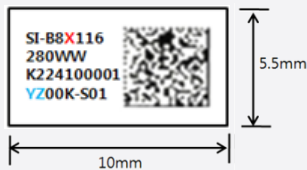

[ Information of Barcode ]

① Model code : SI-B8X116280WW

X : V(3000K), U(3500K), T(4000K), R(5000K), P(6500K)

② Space: Space

③ SMT date : K224 (2010-February-24th)

A(2000), B(2001) ······ J(2009), K(2010), L(2011), ······ (year)

1(January), ······ 9(September), A(October), B(November), C(December)(month)

01, 02, ······ 31th (date)

④ SMT Line No. : 1 line

1~9, A(10), B(11), C(12), D(13), E(14), F(15)

⑤ Serial No. : 00001

00001~99999 : Setting "00001" every working day

⑥ Color temperature : YZ00K

YZ : 30, 35, 40, 50, 65

⑦ LED Maker : -S (Samsung)

⑧ Group No. : 01 (Binning group)

[ QR CODE Information ]

① Example : SI-B8X116280WW\_N321100001YZ00K-S01

② 34 digit : Model code(14) + Space(1) + SMT date(4) + SMT line No.(1) + Serial No.(5)  
+ Color temperature(5) + LED maker(2) + GROUP No.(2)

Model CODE	SI-B8X116280WW
QR CODE Information	SI-B8X116280WW_N321100001YZ00K-S01

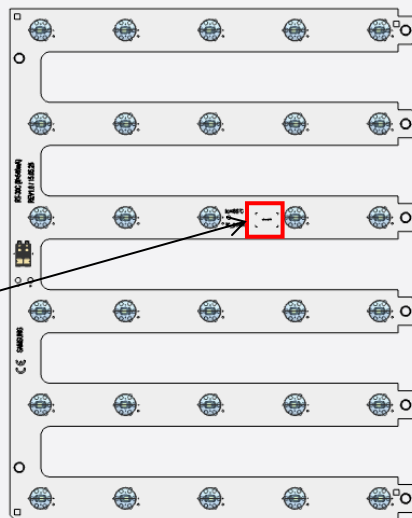
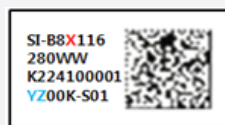

**b) Box Label**

- 100mm x 50mm



The lot number is composed of the following characters:

- ① Product code
- ② Lot ID
- ③ Place of origin
- ④ Quantity
- ⑤ Describe production week
- ⑥ Date of Issue

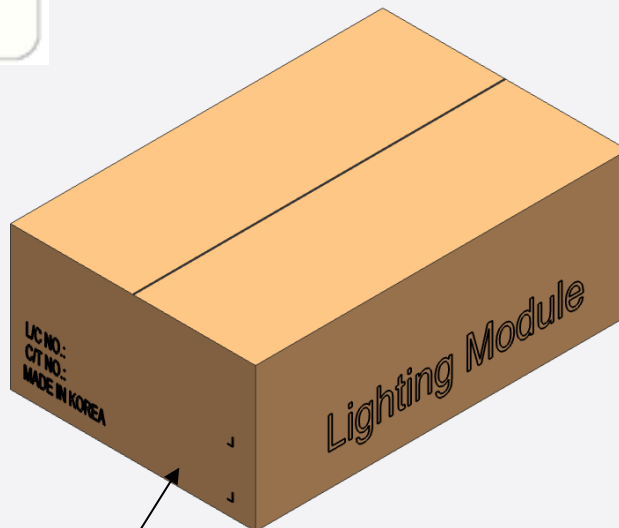

**6. Packing Structure**

ARTICLE	TRAY	BOX	PALLET	REMARKS
Quantity	4 ea	60 ea	1080 ea	

## 7. Precautions in Handling & Use

A. The LED Lighting Modules for white light are devices which are materialized by combining white LEDs.

The color of white light can differ a little unusually to diffuser plate(sign-board panel).

Also when the LEDs are illuminating, operating current should be decided after considering the ambient maximum temperature.

### B. Handling

To prevent the LED Lighting Modules from making any defectives, please handle the LED Lighting Modules with care as follows.

- (1) Don't drop the unit and don't give the unit any shocks.
- (2) Don't bend the PCB and don't touch the LED Resin.
- (3) Don't storage the Module in a dusty place or room.
- (4) Don't take the product apart.
- (5) Don't touch the LED and also PCB and other circuit parts of Module with your naked fingers or sharpness things.
- (6) Take care so that do not pull wire with hand in case of carries or moves LED Lighting Modules.

### C. Cleaning

The LED Lighting Modules should not be used in any type of fluid such as water, oil, organic solvent, etc.

It is recommended that IPA (Isopropyl Alcohol) be used as a solvent for cleaning the LED Lighting Modules.

When using other solvents, it should be confirmed beforehand whether the solvents will dissolve the package and the resin or not. Freon solvents should not be used to clean the LEDs because of worldwide regulations. Do not clean the LED Lighting Modules by the ultrasonic.

Before cleaning, a pre-test should be done to confirm whether any damage to the LED Lighting Modules will occur.

### D. Static Electricity

Static electricity or surge voltage damages the LED Lighting Modules. Please keep the working process anti-static electricity condition to prevent the Lighting from destroying, as following.

- (1) Anyone who handles the unit should be well grounded.(earth ring or anti-static glove)
- (2) Anyone who handles the unit should wear anti-electrostatic working clothes.
- (3) All kinds of device and instruments, such as working table, measuring instruments and assembly jigs in your production lines should be well grounded.

### E. Storage

The LED Lighting Modules must be stored to insert a package of a moisture absorbent material(silica gel) in a box.

### F. Others

If over voltage which exceeds the absolute maximum rating is applied to LED Lighting Modules.

It will cause damage Circuits(that LED is included) and result in destruction.

Do not directly look into lighted LED with naked eyes.

Please use this product within 5 months, which is kept in its original packaging unopened when stocked

### APPENDIX 1. Tc vs Lifetime

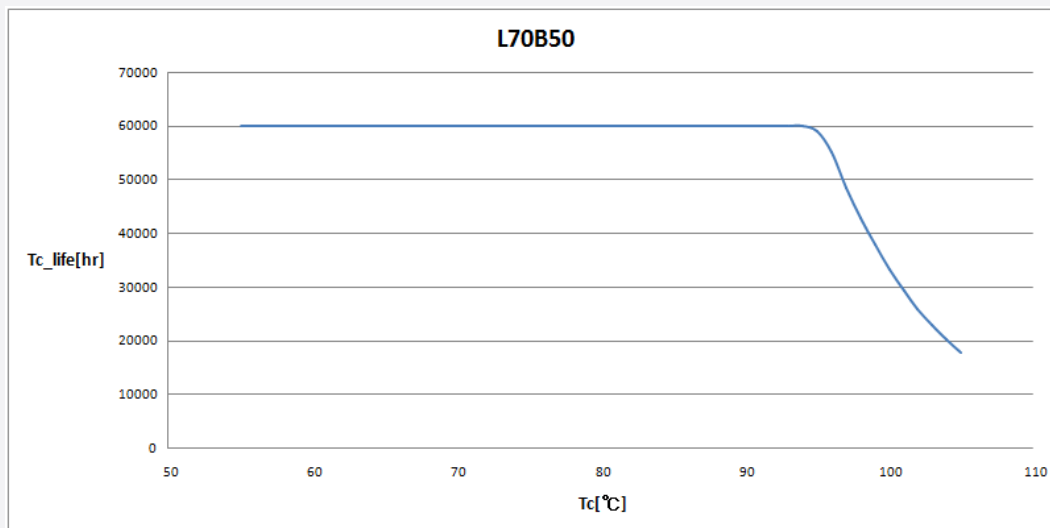

@ 150mA/LED

## APPENDIX 2. $I_r$ vs Luminous Flux

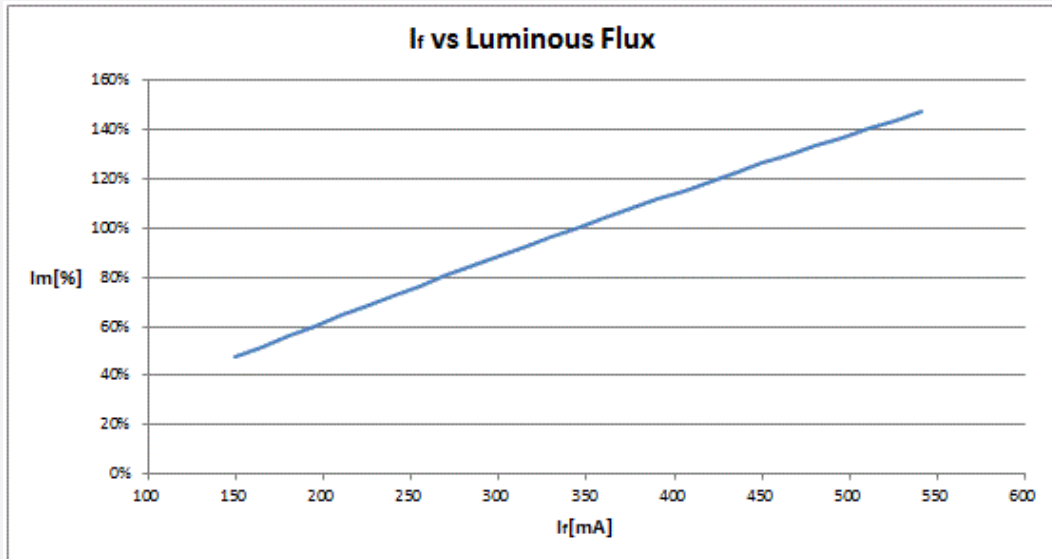

## APPENDIX 3. $I_r$ vs Efficiency

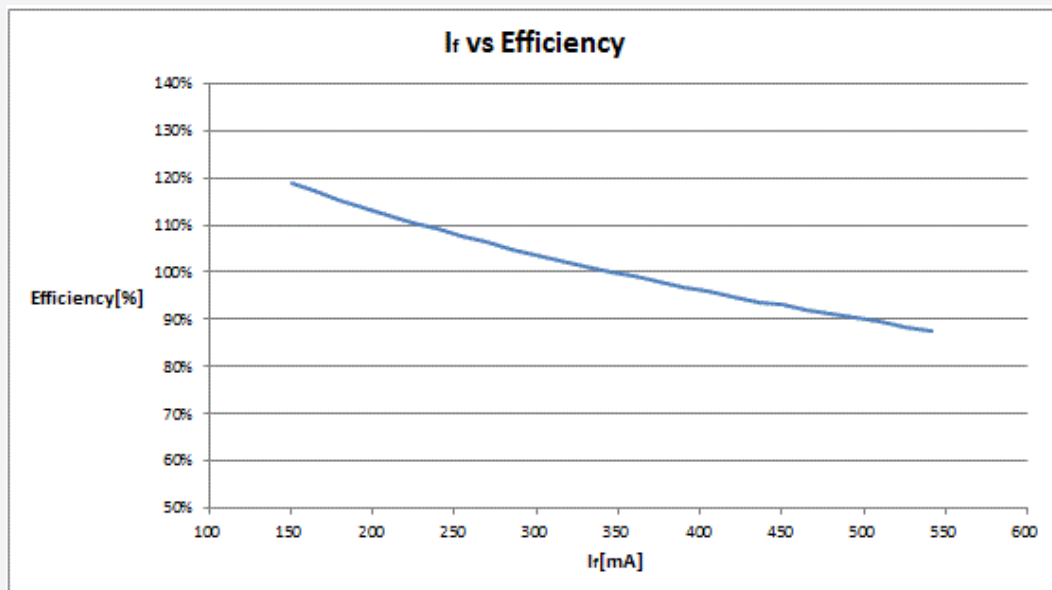

# Legal and additional information.

## [About Samsung Electronics Co., Ltd.](#)

Samsung Electronics Co., Ltd. is a global leader in technology, opening new possibilities for people everywhere. Through relentless innovation and discovery, we are transforming the worlds of TVs, smartphones, tablets, PCs, cameras, home appliances, printers, LTE systems, medical devices, semiconductors and LED solutions. We employ 286,000 people across 80 countries with annual sales of US\$216.7 billion. To discover more, please visit [www.samsungled.com](http://www.samsungled.com).

Copyright © 2015 Samsung Electronics Co., Ltd. All rights reserved.  
Samsung is a registered trademark of Samsung Electronics Co., Ltd.  
Specifications and designs are subject to change without notice. Non-metric weights and measurements are approximate. All data were deemed correct at time of creation. Samsung is not liable for errors or omissions. All brand, product, service names and logos are trademarks and/or registered trademarks of their respective owners and are hereby recognized and acknowledged.

Samsung Electronics Co., Ltd.  
95, Samsung 2-ro  
Giheung-gu  
Yongin-si, Gyeonggi-do, 446-711  
KOREA

[www.samsungled.com](http://www.samsungled.com)

**SAMSUNG**