

## 5 - 18GHz Surface Mount Amplifier with Integrated Bias

### Features

- Wide operating range: 5-18GHz
- 3.3V, 100mA drain bias (gate N/C) for gain and NF:
  - 13 ±0.4dB gain, 7dB NF, 16dBm Psat, 13.5dBm P1dB
- 5V, 130mA drain bias (gate N/C) for power:
  - 12.5 ±0.7dB gain, 9dB NF, 19.5dBm Psat, 17dBm P1dB
- Single supply voltage with self-biasing gate OR direct control of both gate and drain stages

### Application

The UA5M15MP is ideally suited for:

- Point-to-point and point-to-multipoint digital radio
- Spread spectrum broadband communications
- LO driver or mixer isolation amplifier
- General isolation and gain block amplifier

### Description

The UA5M15MP is a two-stage pHEMT amplifier MMIC in a Pb-free leadless plastic QFN package. The IC features a positive gain slope that offsets package loss, resulting in a SMT part with excellent gain flatness across a broad bandwidth. The device can be operated at 5V 130mA for power applications, or 3.3V 100mA for low-noise and gain.

### Surface Mount Package

- 16-pin Pb-free SMT QFN package
- 3x3mm pkg size; 0.5mm pad pitch

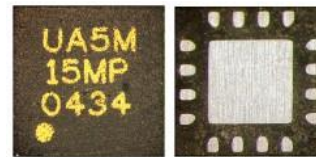

### Functional Diagram

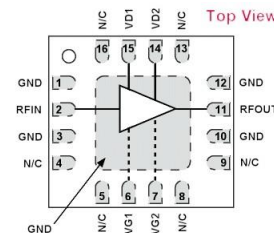

**Key Characteristics:** Specifications pertain to wafer measurements with RF probes and DC bias cards @ 25°C Vd=Vd1=Vd2, Vg=Vg1=Vg2, Id=Id1+Id2, Zo=50Ω

Parameter	Description	Gain Bias: Vd=3.3V, Vg=N/C, Id=100mA			Power Bias: Vd=5V, Vg=N/C, Id=130mA		
		Min	Typ	Max	Min	Typ	Max
S21 (dB)	Small Signal Gain	-	13	-	-	12.5	-
Flatness (±dB)	Gain Flatness	-	0.4	-	-	0.7	-
S11 (dB)	Input Match	-	-14	-	-	-14	-
S22 (dB)	Output Match	-	-11	-	-	-11	-
S12 (dB)	Reverse Isolation	-	-35	-	-	-35	-
P1dB (dBm)	1dB Compressed Output Power	-	13.5	-	-	17	-
Psat (dBm)	Saturated Output Power	-	16	-	-	19.5	-
NF (dB)	Noise Figure	-	7	-	-	9	-

## Typical Probed Performance QFN Package

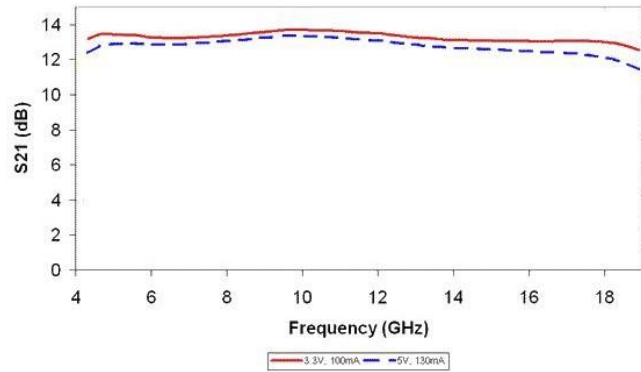
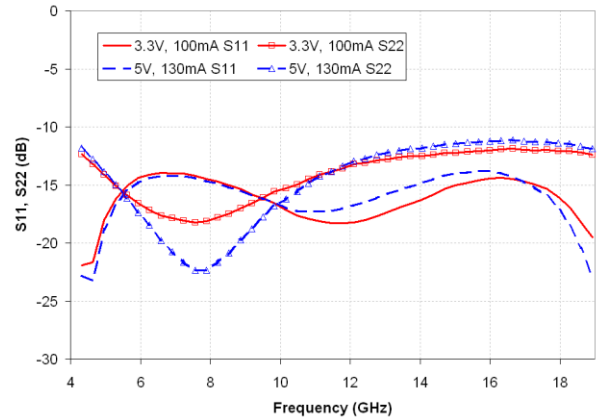
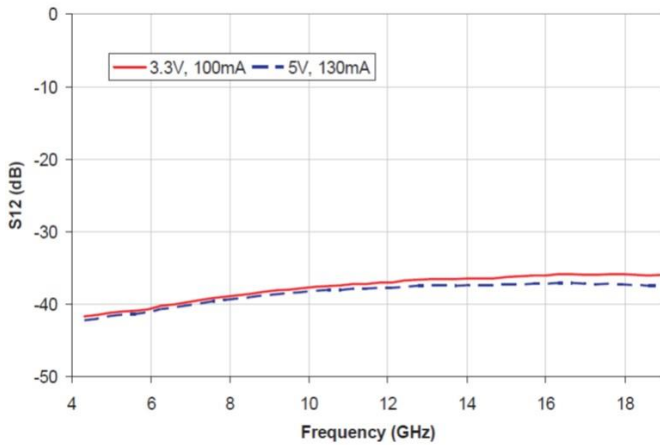
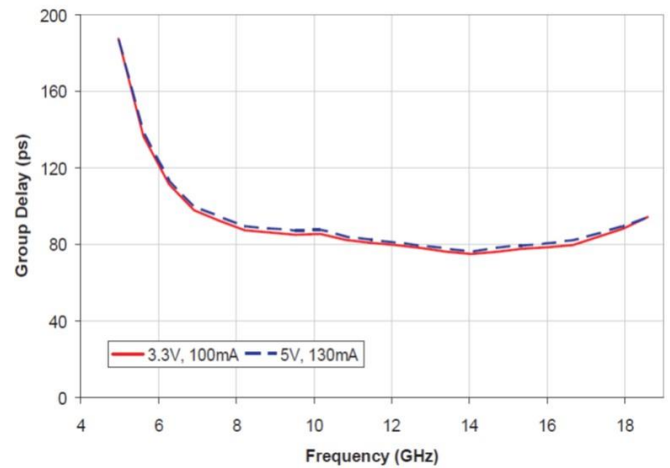
**S21**

**S11, S22**

**S12**

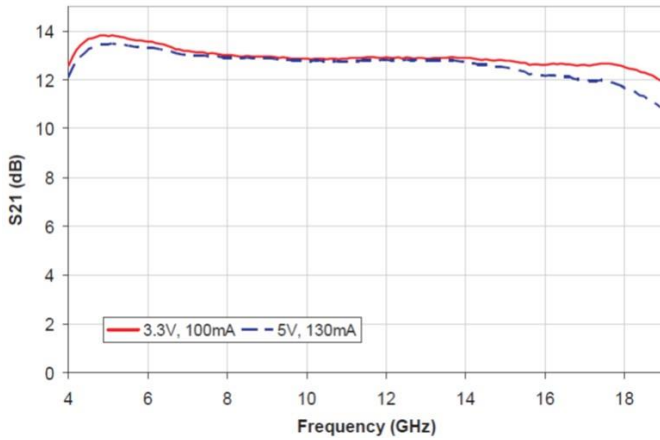
**Group Delay**

## Supplemental Tested in Evaluation Fixture

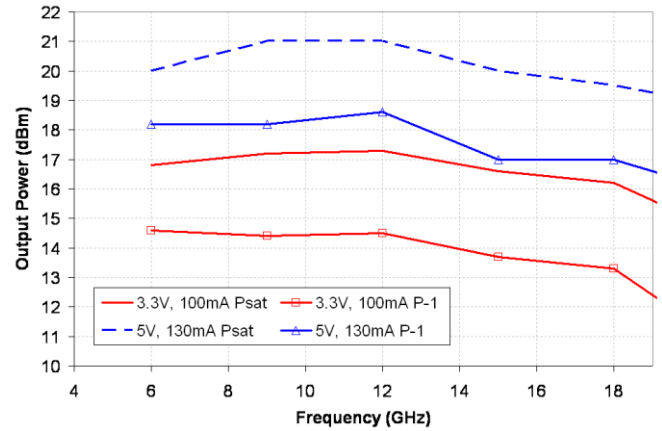
**S21**



**Output Power**



**S11, S22**

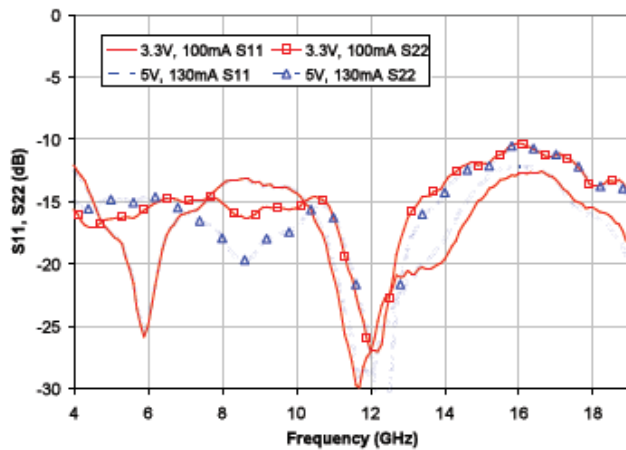

**Noise Figure**

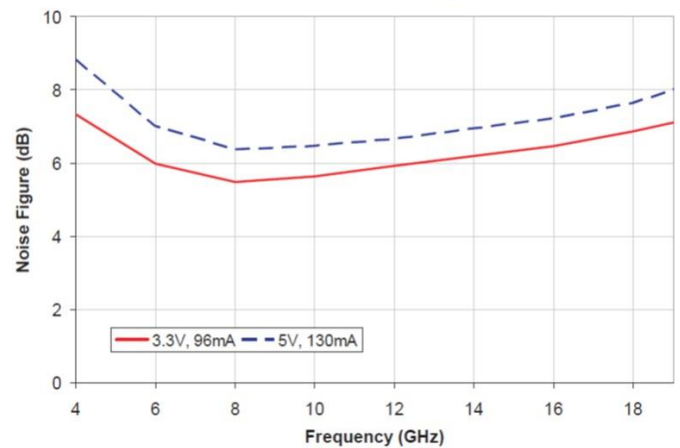

**S12**

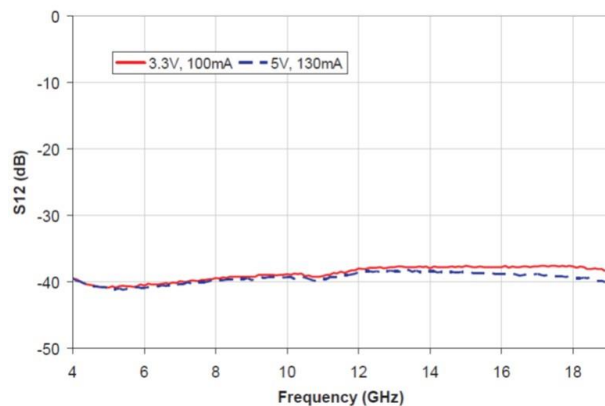

**Group Delay**

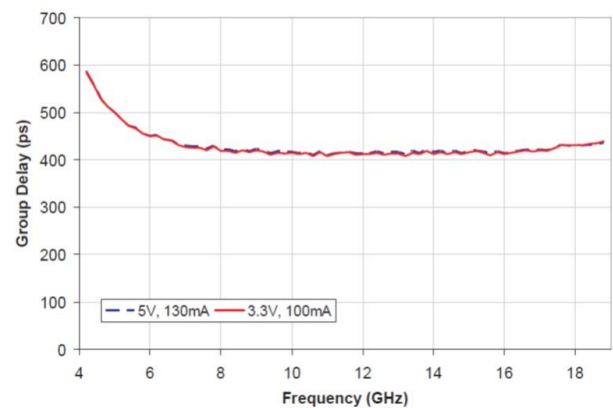

**Table 1: Supplemental Specifications**

Parameter	Description	Min	Typ	Max
Vd1	Drain Bias Voltage FET1	-	3.3V, 5V	6V
Id1	Drain Bias Current FET1	-	-	90mA
Vd2	Drain Bias Voltage FET1	-	3.3V, 5V	6V
Id2	Drain Bias Current FET1	-	-	110mA
Vgg1	Drain Bias Current FET1	-4	N/C	+1V
Vgg2	Drain Bias Current FET1	-4	N/C	+1V
P <sub>in</sub>	Input Power (CW)	-	-	12dBm
P <sub>dc</sub>	Power Dissipation	-	0.33W, 0.65W	-
T <sub>ch</sub>	Channel Temperature	-	-	150°C
Θ <sub>ch</sub>	Thermal Resistance (T <sub>case</sub> =85°C)	-	60°C/W	-
T <sub>STORAGE</sub>	Storage Temperature <sub>1</sub>	-65°C	-	150°C



Caution, ESD Sensitive Device

<sub>1</sub> Passed temperature cycling per JESD22-A104C, -65°C to +150°C, 250 cycles, dwells of 1 minute, 10°C/minute minimum ramp rate.

**Functional Block Diagram**

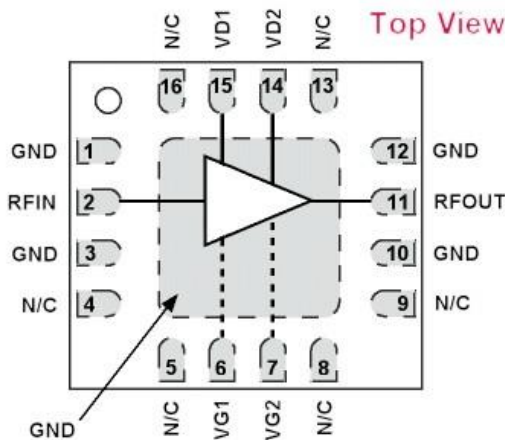

**Table 2: Typical Bias Values**

Vdd (V)	Idd (mA)	App
+5.0	130	Power
+4.0	110	-
+3.3	100	Gain
+2.5	79	Low-noise

**Table 3: Pin Descriptions**

Number	Function	Description
4, 5, 8, 9, 13, 16	N/C	No connection necessary, may be connected to DC/RF ground
1, 3, 10, 12, + paddle	GND	Must be connected to DC/RF ground
2, 11	RF IN, OUT	AC coupled and matched to 50W
6, 7	VG1, VG2	Optional 1st and 2nd gate bias lines, required > 100pF low-freq bypass capacitor if used
14, 15	VD1, VD2	1st and 2nd drain bias lines, requires > 100pF low-freq bypass capacitor and clean power supply

## QB Package Outline

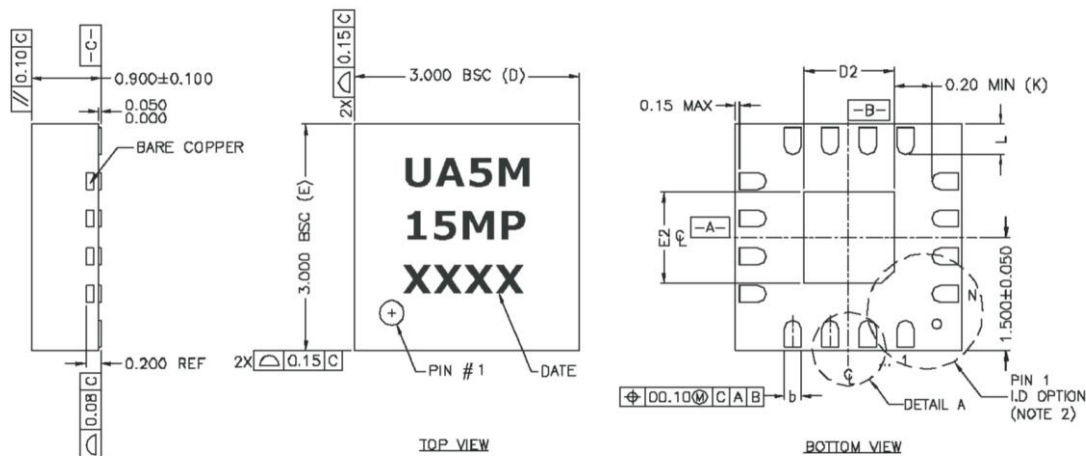

### Package Notes:

- Conforms to JEDEC MO-220, revision 1
- Pin 1 ID indicated by dot on top of package
- All units millimeters, not to scale
- Pkg is 100% Pb free (lead free)
- Leadframe base is 0.2mm Cu 194 FH with Ag-ring finish
- Solder plate is 100% Sn
- All ground leads and center paddle must be connected to RF ground

SYMBOL	VARIATION		
	MIN	NOM	MAX
e	0.50 BSC		
b	0.18	0.23	0.30
E2	1.60	1.70	1.80
D2	1.60	1.70	1.80
L	0.35	0.40	0.45
N	16 LD		
ND	4		
NE	4		
JEDEC VARIATION	N/A		
INTERNAL FEATURE	N/A		
PKG CODE	VQ 016		

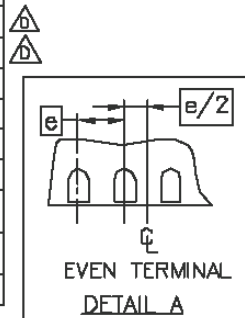

### Lead Free (Pb-free):

The UA5M15MP QFN package contains no lead (Pb) and eliminates the need for costly re-qualification efforts, which are necessary to conform to the European mandated "Restricted use of Hazardous Substances" (RoHS) compliance.

### Thermal Heat Sinking:

To avoid damage and for optimum performance, you must observe the maximum channel temperature and ensure adequate heat sinking. PCB ground planes are not sufficient, the backside of the QFN must be soldered to the PCB, and PCB filled or plated vias must be used to conduct heat away from this contact.

### ESD Handling and Bonding:

This package is ESD sensitive; preventive measures should be taken during handling and solder attach. Solder paste and flux screen printing is recommended.

---

Information contained in this document is proprietary to Microsem. This document may not be modified in any way without the express written consent of Microsemi. Product processing does not necessarily include testing of all parameters. Microsemi reserves the right to change the configuration and performance of the product and to discontinue product at any time.

---

**Microsemi Corporate Headquarters**

One Enterprise, Aliso Viejo CA 92656 USA  
Within the USA: +1 (949) 380-6100  
Sales: +1 (949) 380-6136  
Fax: +1 (949) 215-4996

Microsemi Corporation (Nasdaq: MSCC) offers a comprehensive portfolio of semiconductor and system solutions for communications, defense and security, aerospace, and industrial markets. Products include high-performance and radiation-hardened analog mixed-signal integrated circuits, FPGAs, SoCs, and ASICs; power management products; timing and synchronization devices and precise time solutions, setting the world's standard for time; voice processing devices; RF solutions; discrete components; security technologies and scalable anti-tamper products; Power-over-Ethernet ICs and midspans; as well as custom design capabilities and services. Microsemi is headquartered in Aliso Viejo, Calif. and has approximately 3,400 employees globally. Learn more at [www.microsemi.com](http://www.microsemi.com).

---

© 2014 Microsemi Corporation. All rights reserved. Microsemi and the Microsemi logo are trademarks of Microsemi Corporation. All other trademarks and service marks are the property of their respective owners.