

Vectron International**Filter specification****TFS 140V****1/5****Measurement condition**

Ambient temperature:	23	°C
Input power level:	0.	dBm
Terminating impedance: *		
Input:	50	Ω
Output:	50	Ω

Characteristics**Remark:**

The reference level for the relative attenuation a_{rel} of the TFS 140V is the minimum of the pass band attenuation. This value is defined as the insertion loss a_e . The nominal frequency f_N is fixed at 140,0 MHz without any tolerance. The values of relative attenuation a_{rel} are guaranteed for the whole operating temperature range. The frequency shift of the filter in the operating temperature range is included in the production tolerance scheme.

D a t a		typ. value		tolerance / limit
Insertion loss (reference level)	$a_e = a_{min}$	23	dB	max. 24,25 dB
Nominal frequency		-		140,0 MHz
Pass band	PB	-		$f_N \pm 2,4$ MHz
Pass band ripple (p-p)		0,6	dB	max. 1 dB
Relative attenuation	a_{rel}			
f_N	$f_N \pm 2,45$ MHz	0,8	dB	max. 1 dB
$f_N \pm 2,45$ MHz	$f_N \pm 2,625$ MHz	2,2	dB	max. 3 dB
f_N	$f_N \pm 2,4$ MHz **	0,8	dB	max. 1 dB
$f_N \pm 2,4$ MHz	$f_N \pm 2,6$ MHz **	2,2	dB	max. 3 dB
$f_N + 3,85$ MHz	$f_N + 5$ MHz	52	dB	min. 40 dB
$f_N + 5$ MHz	$f_N + 115$ MHz	56	dB	min. 50 dB
$f_N + 115$ MHz	$f_N + 135$ MHz	32	dB	min. 25 dB
$f_N + 135$ MHz	$f_N + 210$ MHz	54	dB	min. 50 dB
$f_N - 5$ MHz	$f_N - 3,9$ MHz	55	dB	min. 40 dB
$f_N - 110$ MHz	$f_N - 5$ MHz	52	dB	min. 50 dB
Group delay (mean value in PB)		1,8	μs	max. 2,1 μs
Group delay ripple in PB		65	ns	max. 100 ns
Phase linearity in PB		3,5	deg	max. 5 deg
Temperature coefficient of frequency T_{Cf}		- 18	ppm/K	-
Frequency deviation of f_C over temperature		$\Delta f_C(\text{Hz}) = T_{Cf}(\text{ppm/K}) \times (T - T_A) \times f_{CTA}(\text{MHz})$		
Operating temperature range		-		+ 10 °C...+ 70 °C
** extended operating temperature range		-		- 35 °C...+ 80 °C
Storage temperature range		-		- 40 °C... + 85 °C

*) The terminating impedances depend on parasitics and q-values of matching elements and the board used, and are to be understood as reference values only. Should there be additional questions do not hesitate to ask for an application note or contact our design team.

Generated:**Checked / Approved:**

Vectron International GmbH & Co. KG
Potsdamer Straße 18
D 14 513 TELTOW / Germany
Tel: (+49) 3328 4784-0 / Fax: (+49) 3328 4784-30
E-Mail: tft@vectron.com

Vectron International GmbH & Co. KG reserves the right to make changes to the product(s) and/or information contained herein without notice. No liability is assumed as a result of their use or application. No rights under any patent accompany the sale of any such product(s) or information.

Filter characteristic

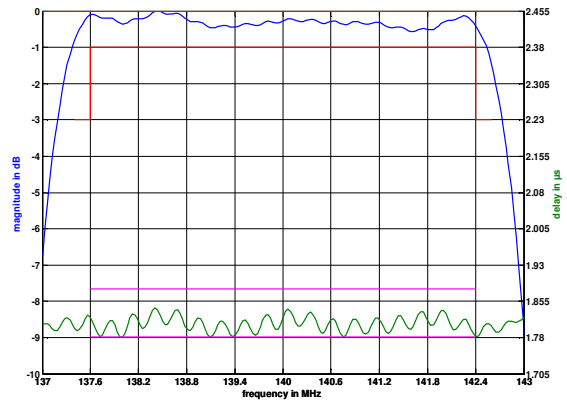
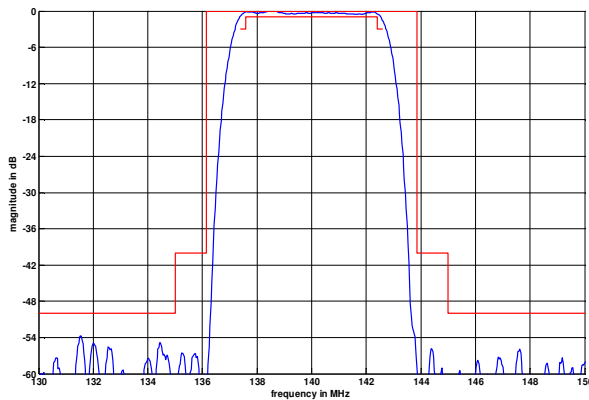

Construction and pin connection

(All dimensions in mm)

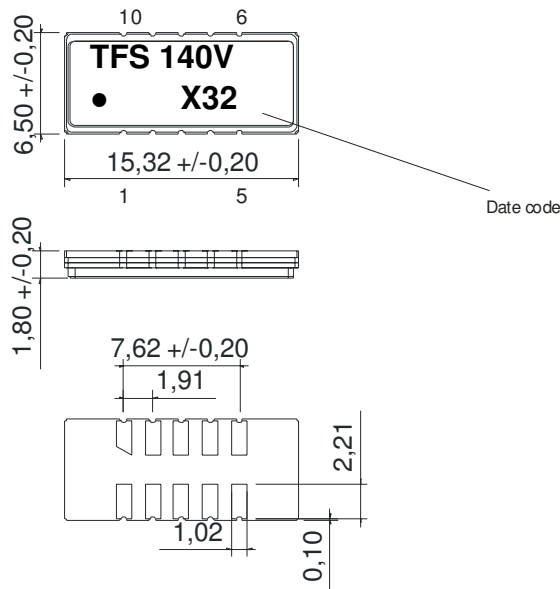

- 1 Input RF Return
- 2 Ground
- 3 Ground
- 4 Ground
- 5 Output
- 6 Output RF Return
- 7 Ground
- 8 Ground
- 9 Ground
- 10 Input

Date code: Year + week
 X 2009
 A 2010
 B 2011
 ...

50 Ohm Test circuit

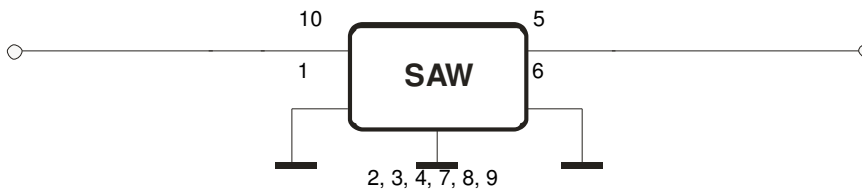

Vectron International GmbH & Co. KG
 Potsdamer Straße 18
 D 14 513 TELTOW / Germany
 Tel: (+49) 3328 4784-0 / Fax: (+49) 3328 4784-30
 E-Mail: tft@vectron.com

Vectron International GmbH & Co. KG reserves the right to make changes to the product(s) and/or information contained herein without notice. No liability is assumed as a result of their use or application. No rights under any patent accompany the sale of any such product(s) or information.

Stability characteristics, reliability

After the following tests the filter shall meet the whole specification:

1. Shock: 500g, 1 ms, half sine wave, 3 shocks each plane;
DIN IEC 68 T2 - 27
2. Vibration: 10 Hz to 500 Hz, 0,35 mm or g respectively, 1 octave per min, 10 cycles per plan, 3 plans;
DIN IEC 68 T2 - 6
3. Change of temperature: -55 °C to 125°C / 30 min. each / 10 cycles
DIN IEC 68 part 2 – 14 Test N
4. Resistance to solder heat (reflow): reflow possible: three times max.;
for temperature conditions refer to the attached "Air reflow temperature conditions" on page 4;
5. ESD ANSI/ESD S20.20-1999, class 1A.

This filter is RoHS compliant (2002/95/EG, 2005/618/EG)

Packing

Tape & Reel: IEC 286 – 3, with exception of value for N and minimum bending radius;
tape type II, embossed carrier tape with top cover tape on the upper side;

max. pieces of filters per reel:	2000
reel of empty components at start:	min. 300 mm
reel of empty components at start including leader:	min. 500 mm
trailer:	min. 300 mm

Tape (all dimensions in mm)

- W : 24,00 ± 0,3
- Po : 4,00 ± 0,1
- Do : 1,50 +0,1/-0
- E : 1,75 ± 0,1
- F : 11,50 ± 0,1
- G(min) : 0,60
- P2 : 2,00 ± 0,1
- P1 : 12,00 ± 0,1
- D1(min) : 1,50
- Ao : 7,10 ± 0,1
- Bo : 15,90 ± 0,1
- Ct : 21,5 ± 0,1

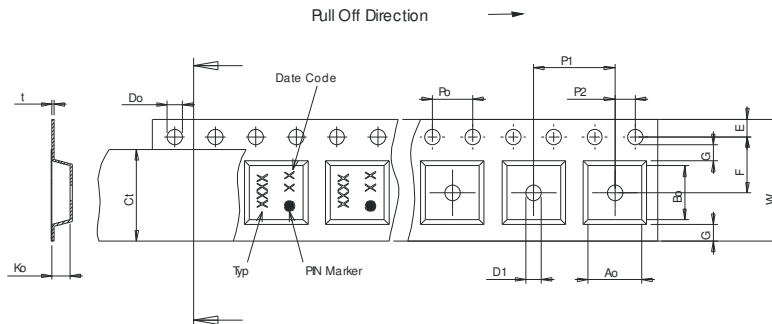

Reel (all dimensions in mm)

- A : 330
- W1 : 24,4 +2/-0
- W2(max) : 30,4
- N(min) : 60
- C : 13,0 +0,5/-0,2

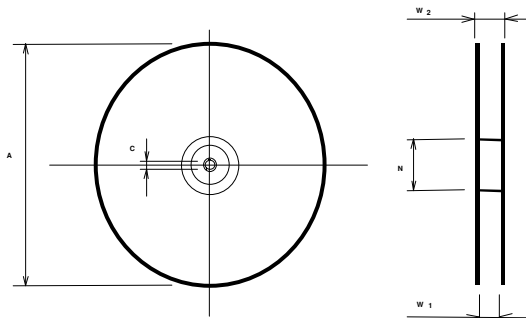

The minimum bending radius is 45 mm.

Vectron International GmbH & Co. KG
Potsdamer Straße 18
D 14 513 TELTOW / Germany
Tel: (+49) 3328 4784-0 / Fax: (+49) 3328 4784-30
E-Mail: tft@vectron.com

Vectron International GmbH & Co. KG reserves the right to make changes to the product(s) and/or information contained herein without notice. No liability is assumed as a result of their use or application. No rights under any patent accompany the sale of any such product(s) or information.

Air reflow temperature conditions

Conditions	Exposure
Average ramp-up rate (30°C to 217°C)	less than 3°C/second
> 100°C	between 300 and 600 seconds
> 150°C	between 240 and 500 seconds
> 217°C	between 30 and 150 seconds
Peak temperature	max. 260°C
Time within 5°C of actual peak temperature	between 10 and 30 seconds
Cool-down rate (Peak to 50°C)	less than 6°C/second
Time from 30°C to Peak temperature	no greater than 300 seconds

Chip-mount air reflow profile

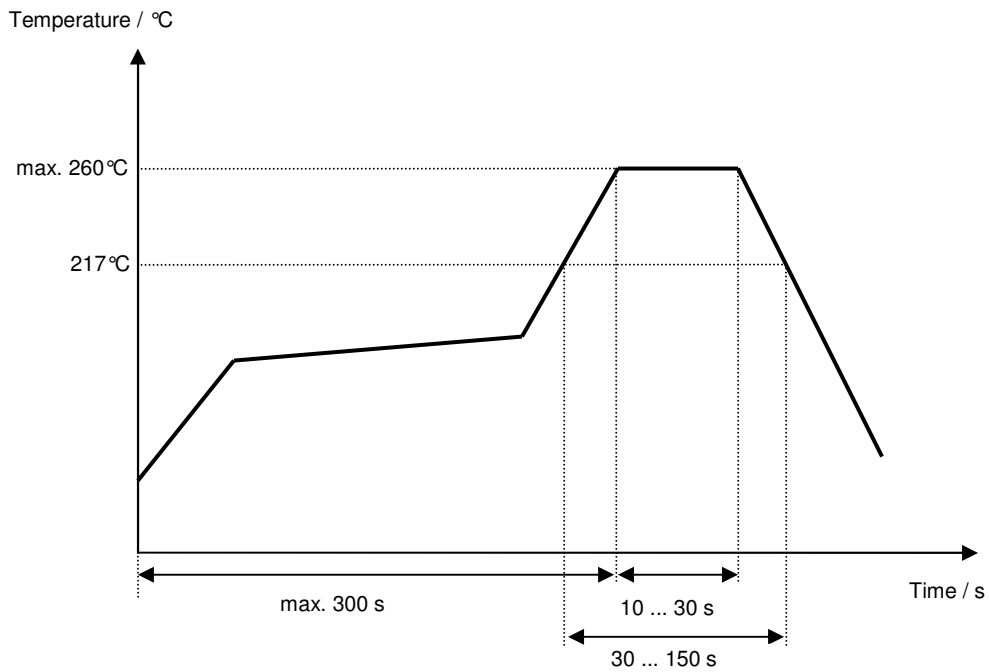

Vectron International GmbH & Co. KG
 Potsdamer Straße 18
 D 14 513 TELTOW / Germany
 Tel: (+49) 3328 4784-0 / Fax: (+49) 3328 4784-30
 E-Mail: tft@vectron.com

Vectron International GmbH & Co. KG reserves the right to make changes to the product(s) and/or information contained herein without notice. No liability is assumed as a result of their use or application. No rights under any patent accompany the sale of any such product(s) or information.

History

Version	Reason of changes	Name	Date
1.0	- generate specification according to customer requirements	Pfeiffer	10.04.2003
1.1	- terminating impedance fixed, typical values and test configuration added	Pfeiffer	22.08.2003
1.2	- operating temperature range extended - change of relative attenuation (pass band) - filter characteristics added, matching configuration corrected - stability characteristics modified - air reflow temperature conditions changed	Pfeiffer	30.08.2006
2.0	- change of relative attenuation (stop band)	Pfeiffer	07.08.2009

Vectron International GmbH & Co. KG
Potsdamer Straße 18
D 14 513 TELTOW / Germany
Tel: (+49) 3328 4784-0 / Fax: (+49) 3328 4784-30
E-Mail: tft@vectron.com

Vectron International GmbH & Co. KG reserves the right to make changes to the product(s) and/or information contained herein without notice. No liability is assumed as a result of their use or application. No rights under any patent accompany the sale of any such product(s) or information.