



The SST12LP07 is a versatile power amplifier based on the highly-reliable InGaP/GaAs HBT technology. Easily configured for high-power applications with good power-added efficiency while operating over the 2.4- 2.5 GHz frequency band, the SST12LP07 has excellent linearity, typically ~2.5% added EVM at 19 dBm output power, while meeting 802.11g spectrum mask at 22 dBm. The SST12LP07 features easy board-level usage along with high-speed power-up/down control through a single combined reference voltage pin, and is offered in a 16-contact VQFN package.

## Features

- **High Gain:**
  - Typically 29 dB gain across 2.4–2.5 GHz over temperature 0°C to +85°C
- **High linear output power:**
  - >26 dBm P1dB
  - Please refer to “Absolute Maximum Stress Ratings” on page 5
  - Meets 802.11g OFDM ACPR requirement up to 22 dBm
  - ~2.5% added EVM up to 19 dBm for 54 Mbps 802.11g signal
  - Meets 802.11b ACPR requirement up to 22 dBm
- **High power-added efficiency/Low operating current for both 802.11g/b applications**
  - ~22%/220 mA @  $P_{OUT} = 22$  dBm for 802.11g
  - ~21%/230 mA @  $P_{OUT} = 22$  dBm for 802.11b
- **Single-pin low  $I_{REF}$  power-up/down control**
  - $I_{REF} < 2$  mA
- **Low idle current**
  - ~70 mA  $I_{CQ}$
- **High-speed power-up/down**
  - Turn on/off time (10%- 90%) <100 ns
  - Typical power-up/down delay with driver delay included <200 ns
- **High temperature stability**
  - ~1 dB gain/power variation between 0°C to +85°C
- **Low shut-down current (< 0.1  $\mu$ A)**
- **Excellent On-chip power detection**
  - <+/- 0.3dB variation between 0°C to +85°C
  - <+/- 0.4dB variation with 2:1 VSWR mismatch
  - <+/- 0.3dB variation Ch1 through Ch14
- **20 dB dynamic range on-chip power detection**
- **Simple input/output matching**
- **Packages available**
  - 16-contact VQFN – 3mm x 3mm
- **All non-Pb (lead-free) devices are RoHS compliant**

## Applications

- WLAN (IEEE 802.11g/b)
- Home RF
- Cordless phones
- 2.4 GHz ISM wireless equipment



## Product Description

The SST12LP07 is a versatile power amplifier based on the highly-reliable InGaP/GaAs HBT technology.

The SST12LP07 can be easily configured for high-power applications with good power-added efficiency while operating over the 2.4- 2.5 GHz frequency band. This device typically provides 29 dB gain with 22% power-added efficiency @  $P_{OUT} = 22$  dBm for 802.11g and 21% power-added efficiency @  $P_{OUT} = 22$  dBm for 802.11b.

The SST12LP07 has excellent linearity, typically ~2.5% added EVM at 19 dBm output power which is essential for 54 Mbps 802.11g/n operation while meeting 802.11g spectrum mask at 22 dBm. The SST12LP07 can also be configured for high-efficiency operation, typically 17 dBm linear 54 Mbps 802.11g output power at 85 mA total power consumption. High-efficiency operation is desirable in embedded applications such as in hand-held units.

The SST12LP07 also features easy board-level usage along with high-speed power-up/down control through a single combined reference voltage pin. Ultra-low reference current (total  $I_{REF} \sim 2$  mA) makes the SST12LP07 controllable by an on/off switching signal directly from the baseband chip. These features coupled with low operating current make the SST12LP07 ideal for the final stage power amplification in battery-powered 802.11g/b WLAN transmitter applications.

The SST12LP07 has an excellent on-chip, single-ended power detector, which features wide-range (~20 dB) with dB-wise linearization and high stability over temperature (< +/-0.3 dB 0°C to +85°C), frequency (< +/-0.3 dB across Channels 1 through 14), and output load (< +/-0.4 dB with 2:1 output VSWR all phases). The excellent on-chip power detector provides a reliable solution to board-level power control.

The SST12LP07 is offered in a 16-contact VQFN package. See Figure 2 for pin assignments and Table 1 for pin descriptions.



### Functional Blocks

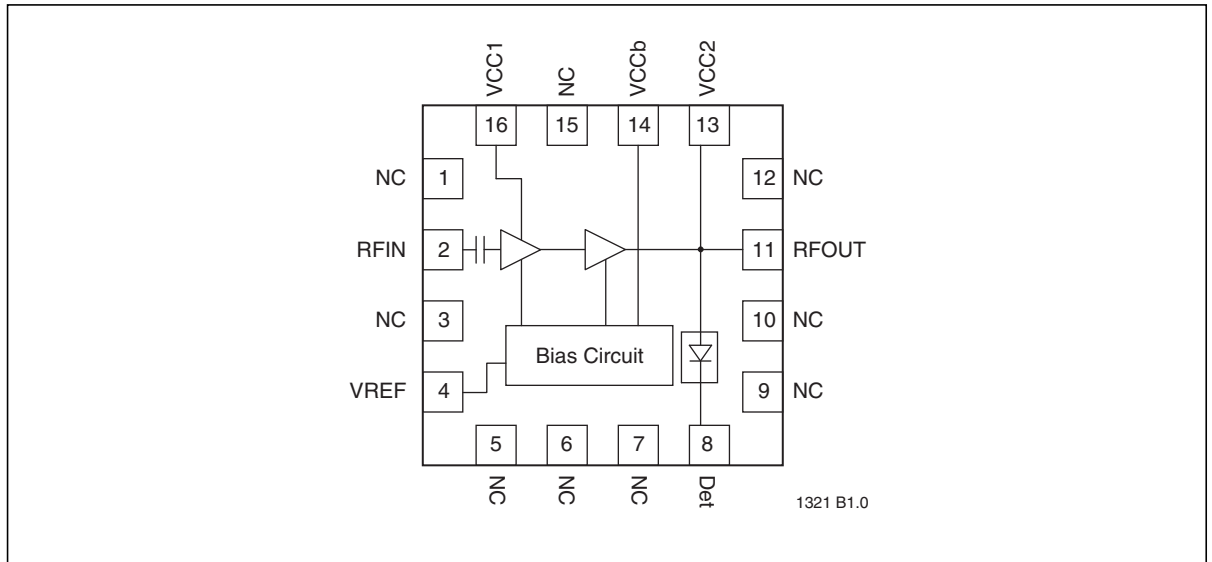

**Figure 1:** Functional Block Diagram



### Pin Assignments

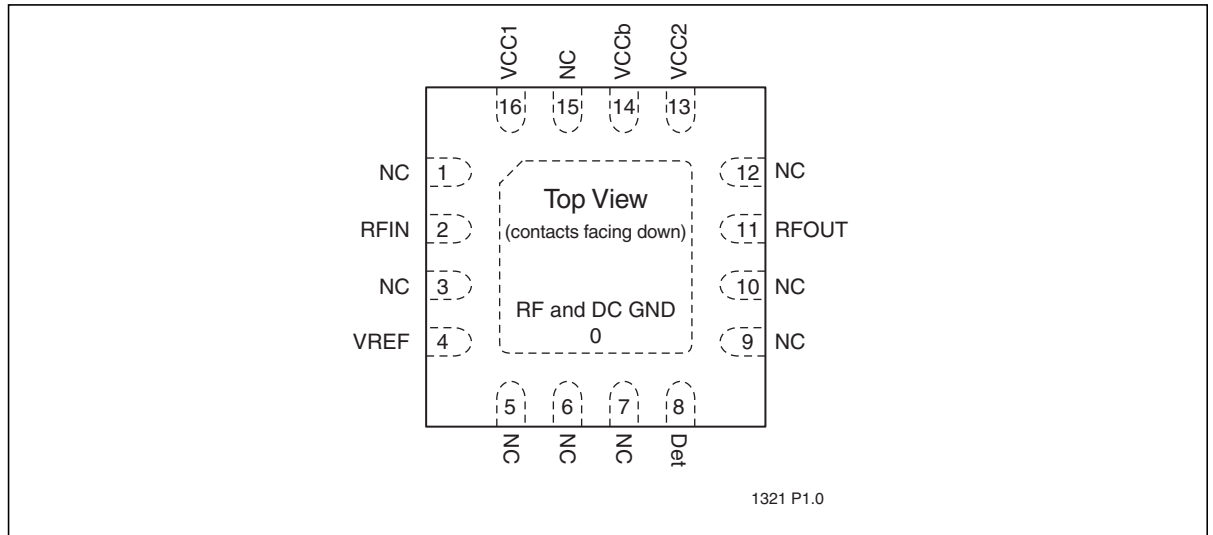

Figure 2: Pin Assignments for 16-contact VQFN

### Pin Descriptions

Table 1: Pin Description

Symbol	Pin No.	Pin Name	Type <sup>1</sup>	Function
GND	0	Ground		The center pad should be connected to RF ground with several low inductance, low resistance vias
NC	1	No Connection		Unconnected pin
RFIN	2		I	RF input, DC decoupled
NC	3	No Connection		Unconnected pin
VREF	4		I	1 <sup>st</sup> and 2 <sup>nd</sup> stage idle current control
NC	5	No Connection		Unconnected pin
NC	6	No Connection		Unconnected pin
NC	7	No Connection		Unconnected pin
Det	8		O	On-chip power detector
NC	9	No Connection		Unconnected pin
NC	10	No Connection		Unconnected pin
RFOUT	11		O	RF output
NC	12	No Connection		Unconnected pin
VCC2	13	Power Supply	PWR	Power supply, 2 <sup>nd</sup> stage
VCCb	14	Power Supply	PWR	Power supply, bias circuit
NC	15	No Connection		Unconnected pin
VCC1	16	Power Supply	PWR	Power supply, 1 <sup>st</sup> stage

1. I=Input, O=Output



# 2.4 GHz High-Power, High-Gain Power Amplifier

## SST12LP07

### Electrical Specifications

The AC and DC specifications for the power amplifier interface signals. Refer to Table 3 for the DC voltage and current specifications. Refer to Figures 3 through 11 for the RF performance.

**Absolute Maximum Stress Ratings** (Applied conditions greater than those listed under “Absolute Maximum Stress Ratings” may cause permanent damage to the device. This is a stress rating only and functional operation of the device at these conditions or conditions greater than those defined in the operational sections of this data sheet is not implied. Exposure to absolute maximum stress rating conditions may affect device reliability.)

Input power to pin 2 ( $P_{IN}$ )	+5 dBm
Average output power ( $P_{OUT}$ ) <sup>1</sup>	+26 dBm
Supply Voltage at pins 13, 14, and 16 ( $V_{CC}$ )	-0.3V to +4.0V
Reference voltage to pin 4 ( $V_{REF}$ )	-0.3V to +3.3V
DC supply current ( $I_{CC}$ )	400 mA
Operating Temperature ( $T_A$ )	-40°C to +85°C
Storage Temperature ( $T_{STG}$ )	-40°C to +120°C
Maximum Junction Temperature ( $T_J$ )	+150°C
Surface Mount Solder Reflow Temperature	260°C for 10 seconds

1. Never measure with CW source. Pulsed single-tone source with <50% duty cycle is recommended. Exceeding the maximum rating of average output power could cause permanent damage to the device.

**Table 2: Operating Range**

Range	Ambient Temp	$V_{DD}$
Industrial	-40°C to +85°C	3.3V

T2.1 75033

**Table 3: DC Electrical Characteristics**

Symbol	Parameter	Min.	Typ	Max.	Unit	Test Conditions
$V_{CC}$	Supply Voltage at pins 13, 14, 16	3.0	3.3	3.6	V	
$I_{CC}$	Supply Current					
	for 802.11g, 22 dBm		220		mA	
$I_{CQ}$	Supply Current					
	for 802.11b, 22 dBm		230		mA	
$I_{CQ}$	Idle current for 802.11g to meet EVM <2.5% @ 19 dBm		70		mA	
$I_{OFF}$	Shut down current			0.1	$\mu$ A	
$V_{REG}$	Reference Voltage for, with 110 $\Omega$ resistor	2.7 5	2.8 5	2.95	V	

T3.0 75033



# 2.4 GHz High-Power, High-Gain Power Amplifier

## SST12LP07

Data Sheet

**Table 4:** AC Electrical Characteristics for Configuration

Symbol	Parameter	Min.	Typ	Max.	Unit
F <sub>L-U</sub>	Frequency range	2400		2485	MHz
P <sub>OUT</sub>	Output power				
	@ PIN = -6 dBm 11b signals	22			dBm
	@ PIN = -7 dBm 11g signals	21			dBm
G	Small signal gain	28	29		dB
G <sub>VAR1</sub>	Gain variation over band (2400~2485 MHz)			±0.5	dB
G <sub>VAR2</sub>	Gain ripple over channel (20 MHz)		0.2		dB
ACPR	Meet 11b spectrum mask	22			dBm
	Meet 11g OFDM 54 Mbps spectrum mask	22			dBm
Added EVM	@ 19 dBm output with 11g OFDM 54 Mbps signal		2.5		%
2f, 3f, 4f, 5f	Harmonics at 22 dBm, without external filters		-40		dBc

T4.2 75033



### Typical Performance Characteristics

Test Conditions:  $V_{CC} = 3.3V$ ,  $T_A = 25^\circ C$ , unless otherwise specified

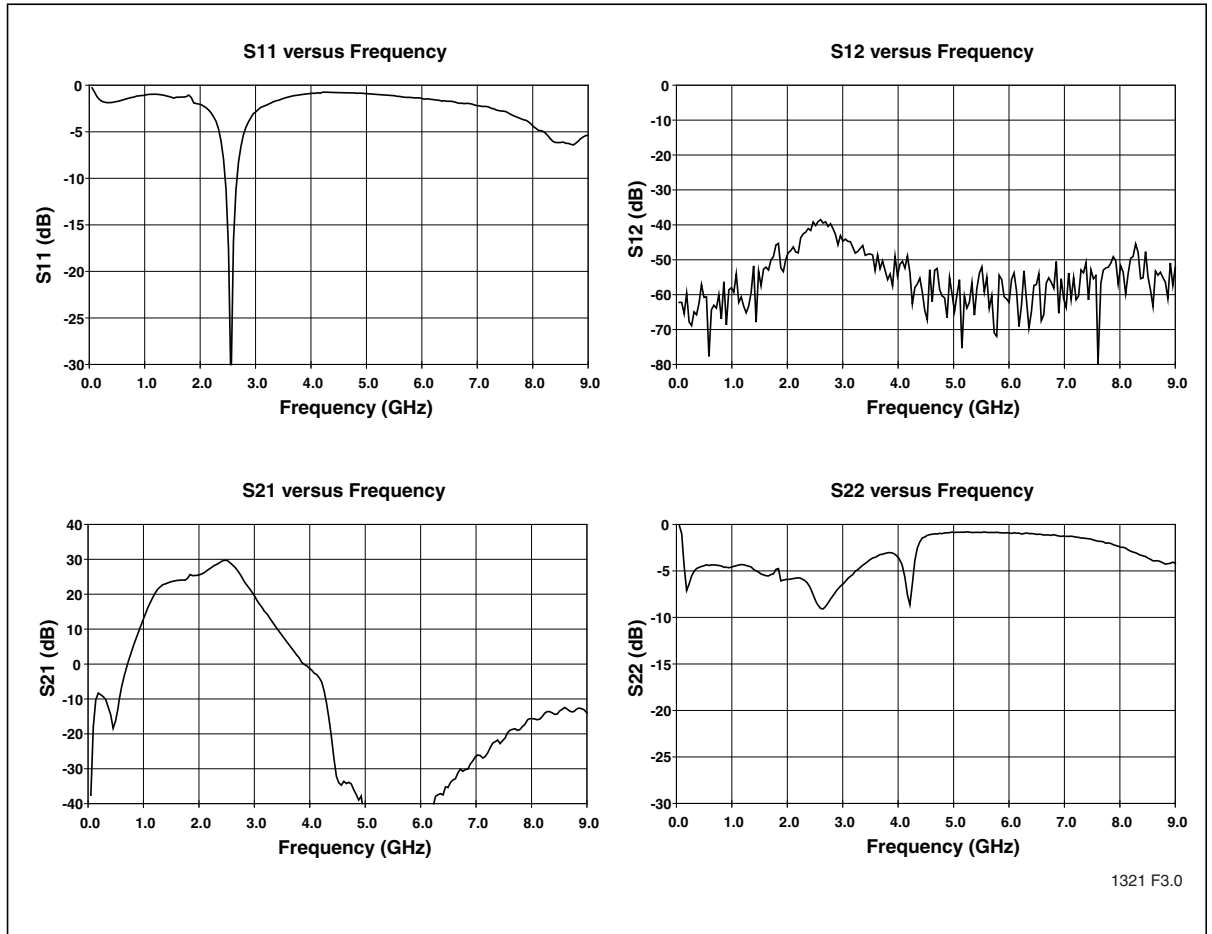

Figure 3: S-Parameters



### Typical Performance Characteristics

Test Conditions:  $V_{CC} = 3.3V$ ,  $T_A = 25^\circ C$ , 54 Mbps 802.11g OFDM signal

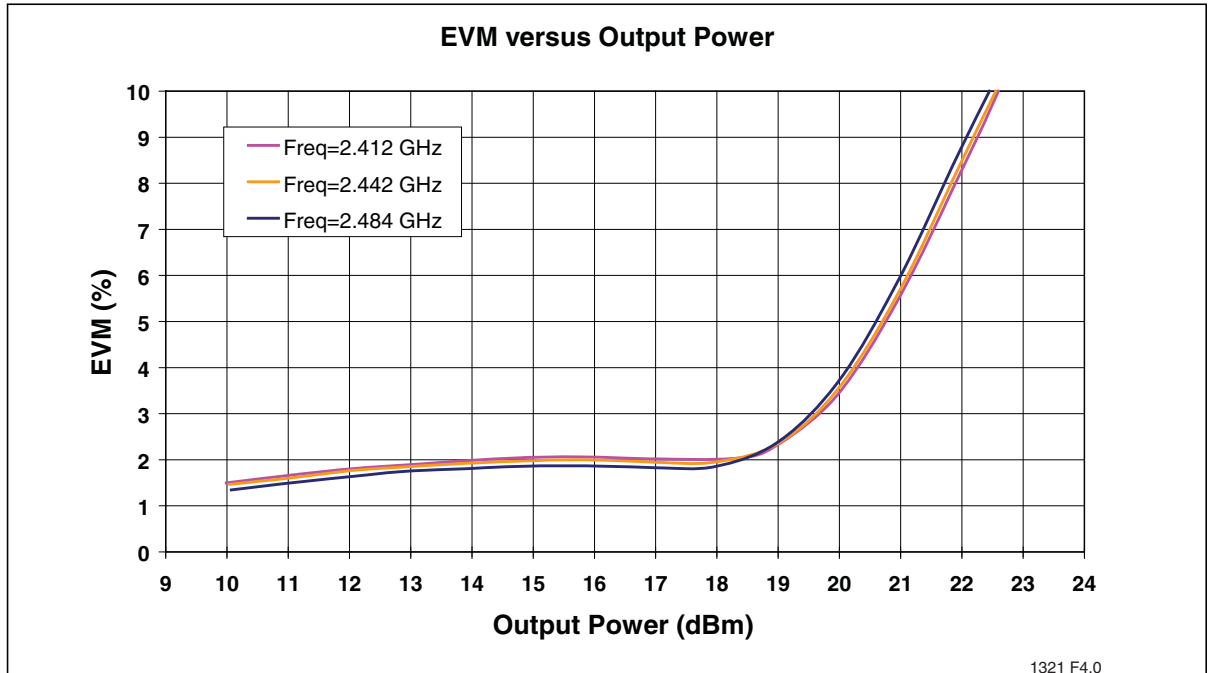

Figure 4: EMV versus Output Power

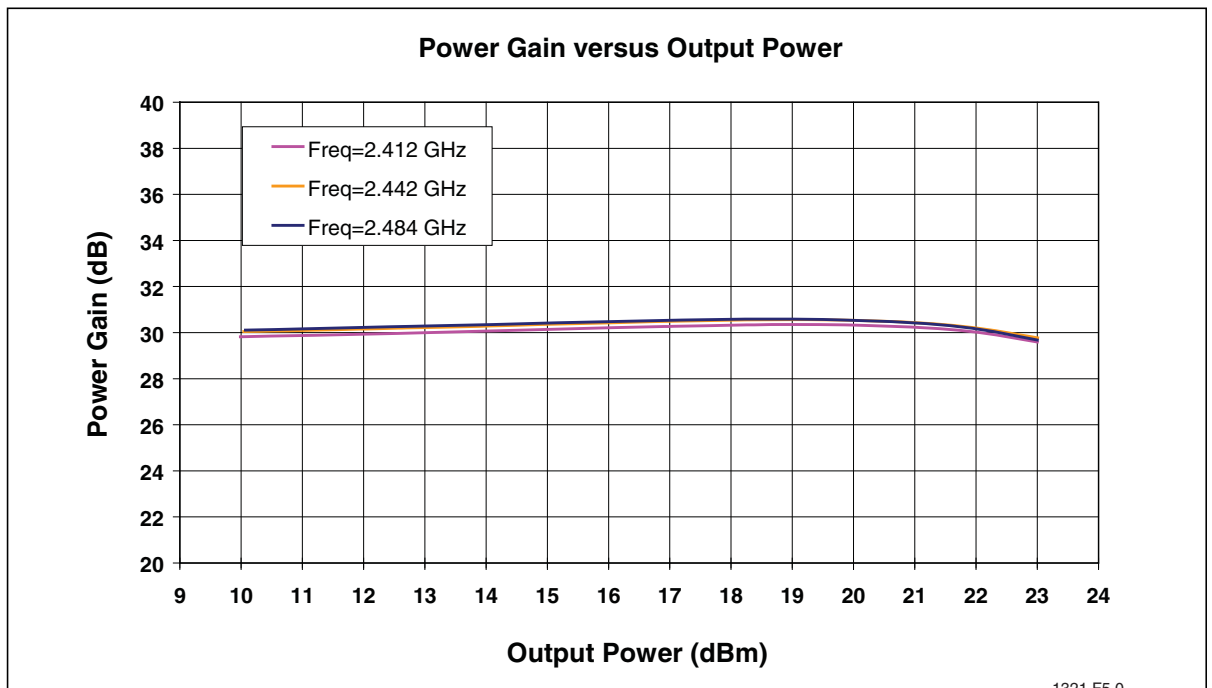

Figure 5: Power Gain versus Output Power





# 2.4 GHz High-Power, High-Gain Power Amplifier

## SST12LP07

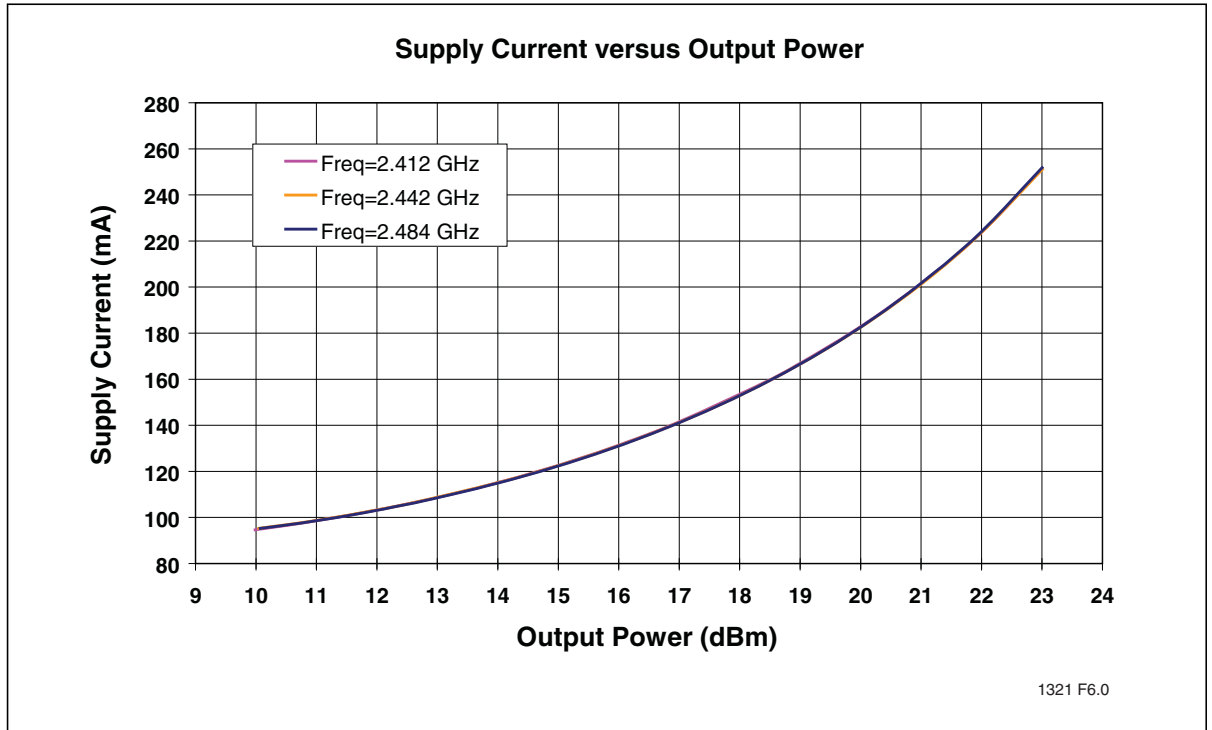

Figure 6: Total Current Consumption for 802.11g operation versus Output Power

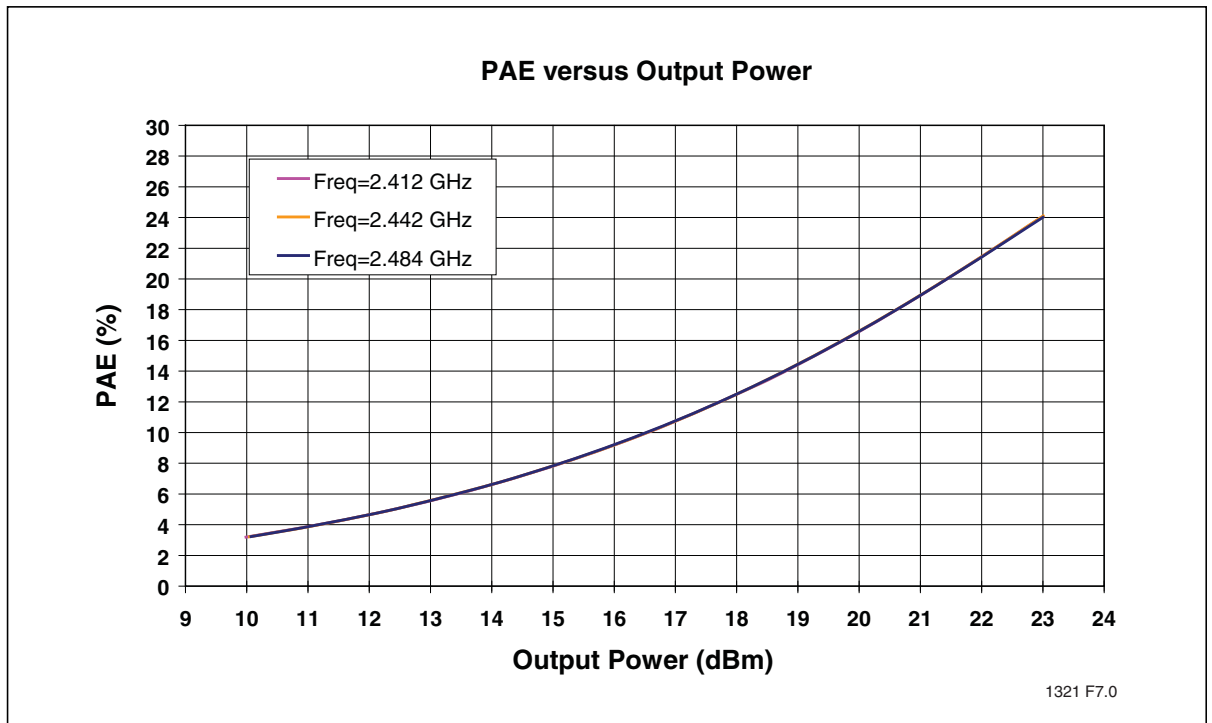

Figure 7: PAE versus Output Power



# 2.4 GHz High-Power, High-Gain Power Amplifier

## SST12LP07

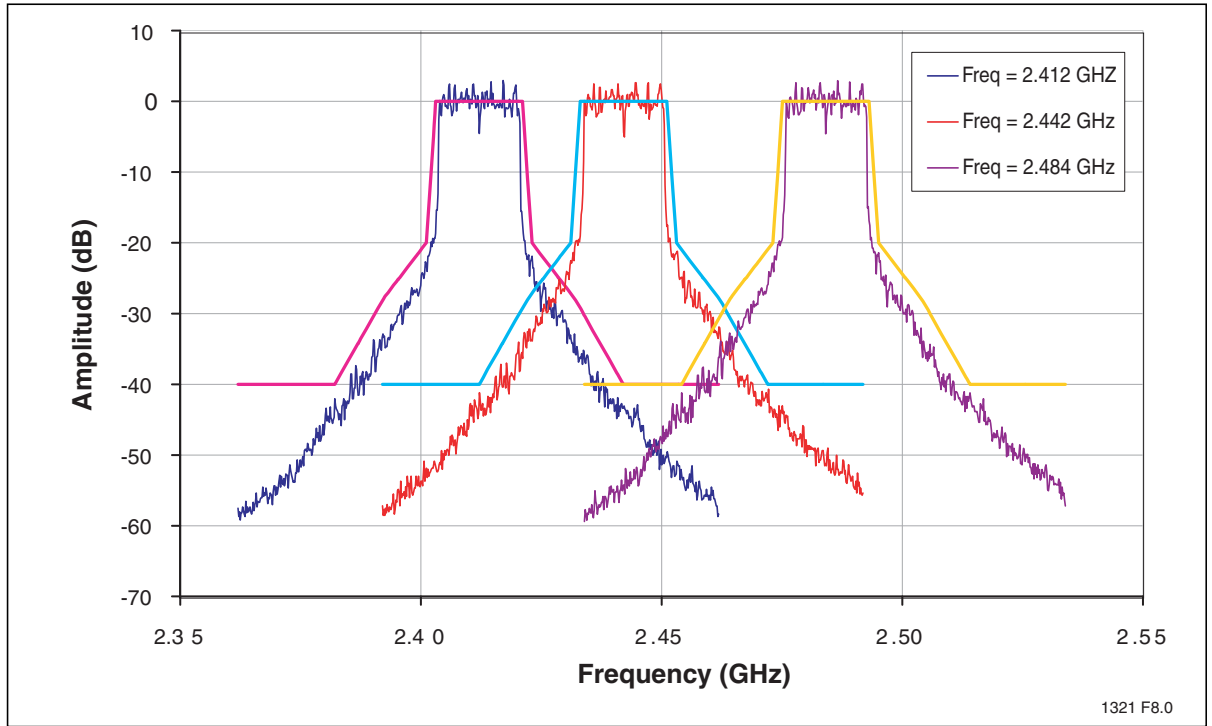

Figure 8: 802.11g Spectrum Mask at 22 dBm

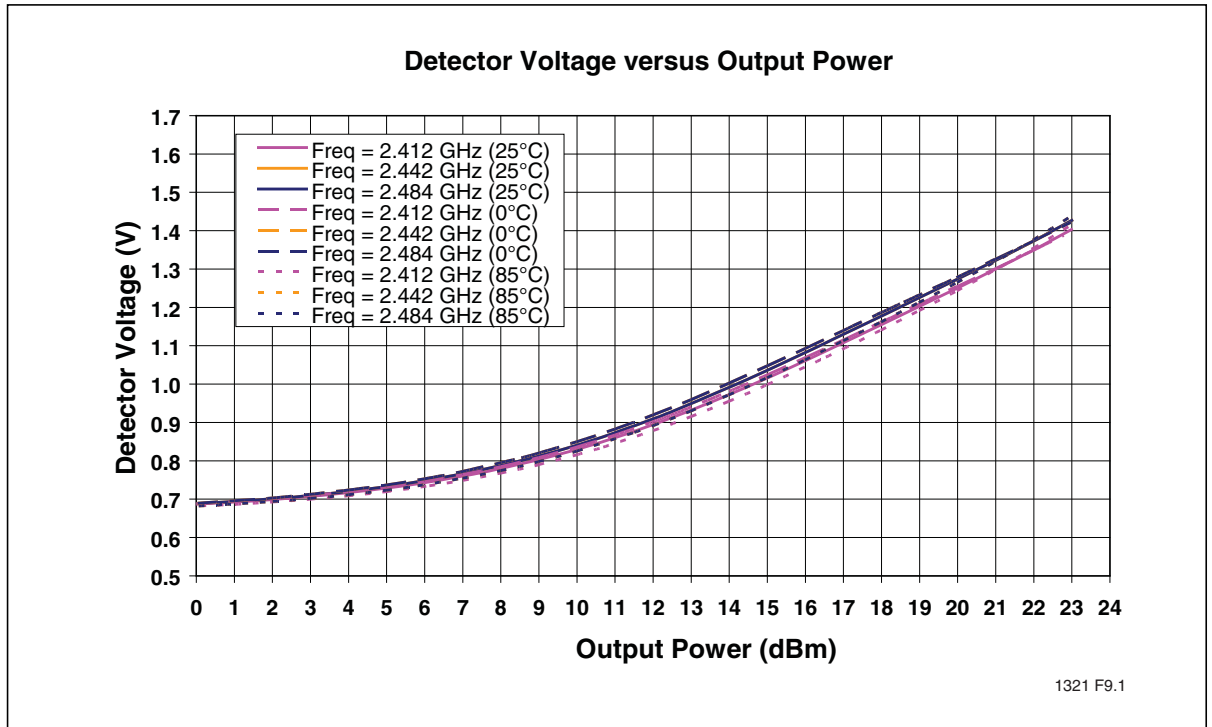

Figure 9: Detector Characteristics Over Temperature and Over Frequency



# 2.4 GHz High-Power, High-Gain Power Amplifier SST12LP07

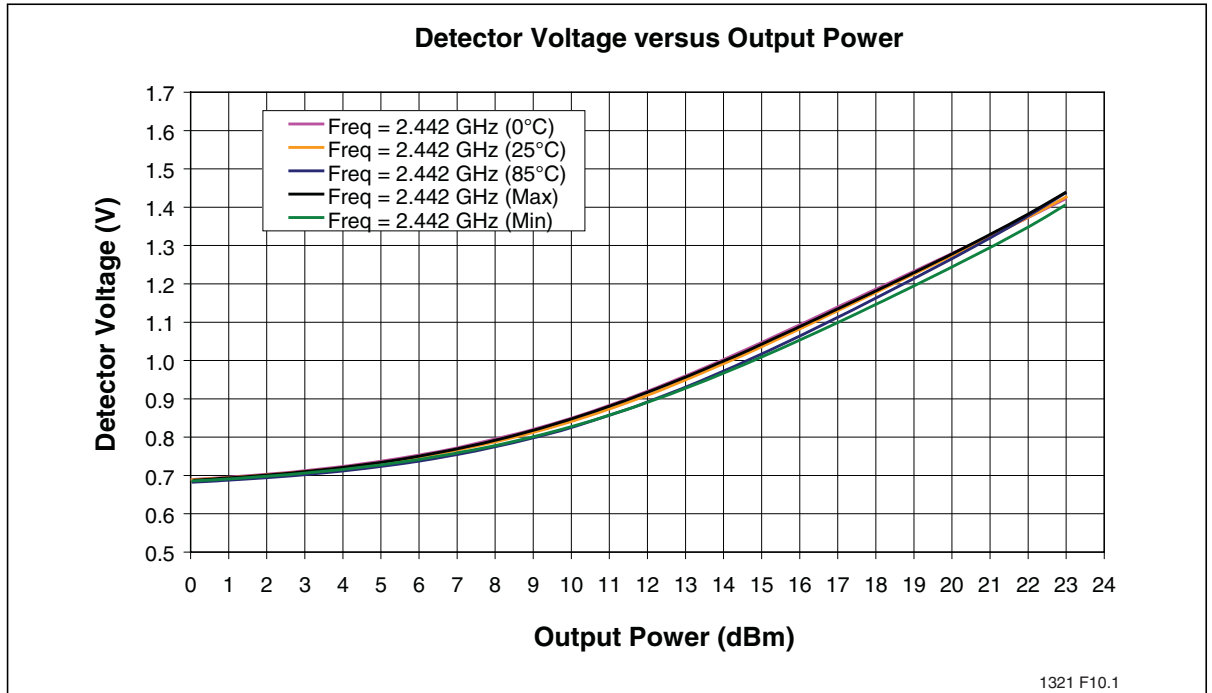

Figure 10: CH7 Detector Characteristics Over Temperature with 2:1 Output VSWR All Phases

Test Conditions:  $V_{CC} = 3.3V$ ,  $T_A = 25^\circ C$ , 1 Mbps 802.11B CCK signal

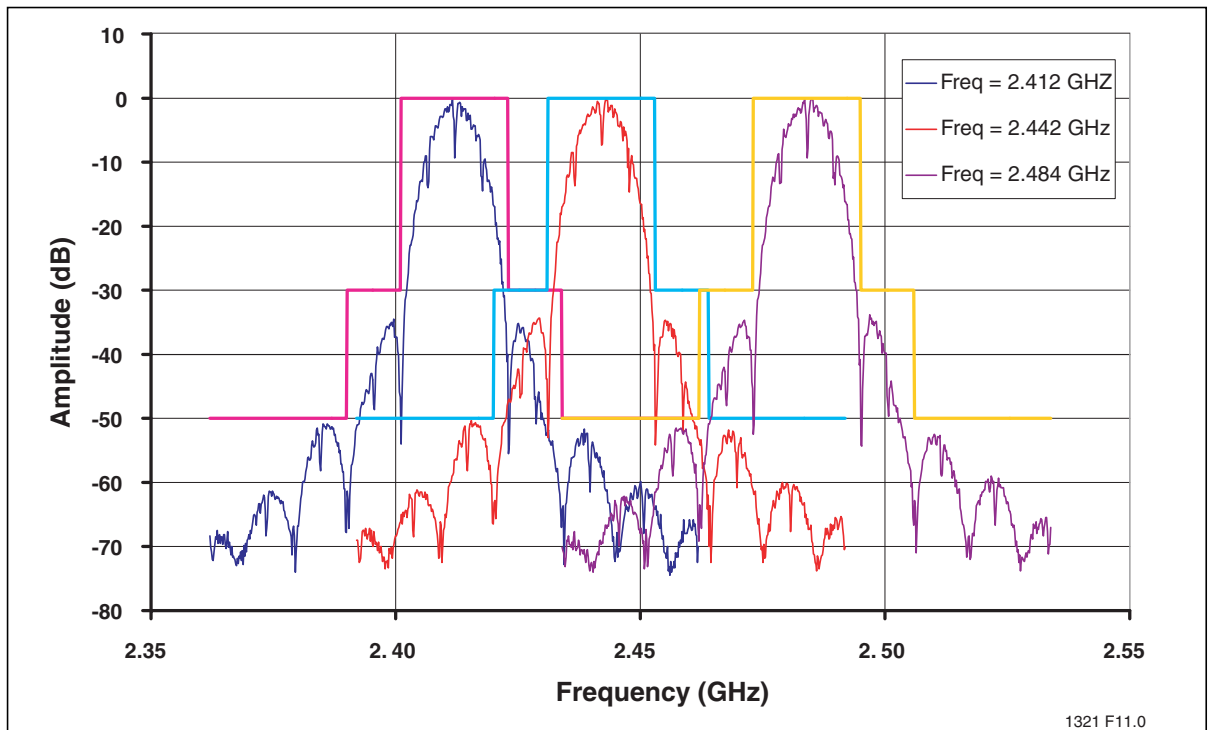
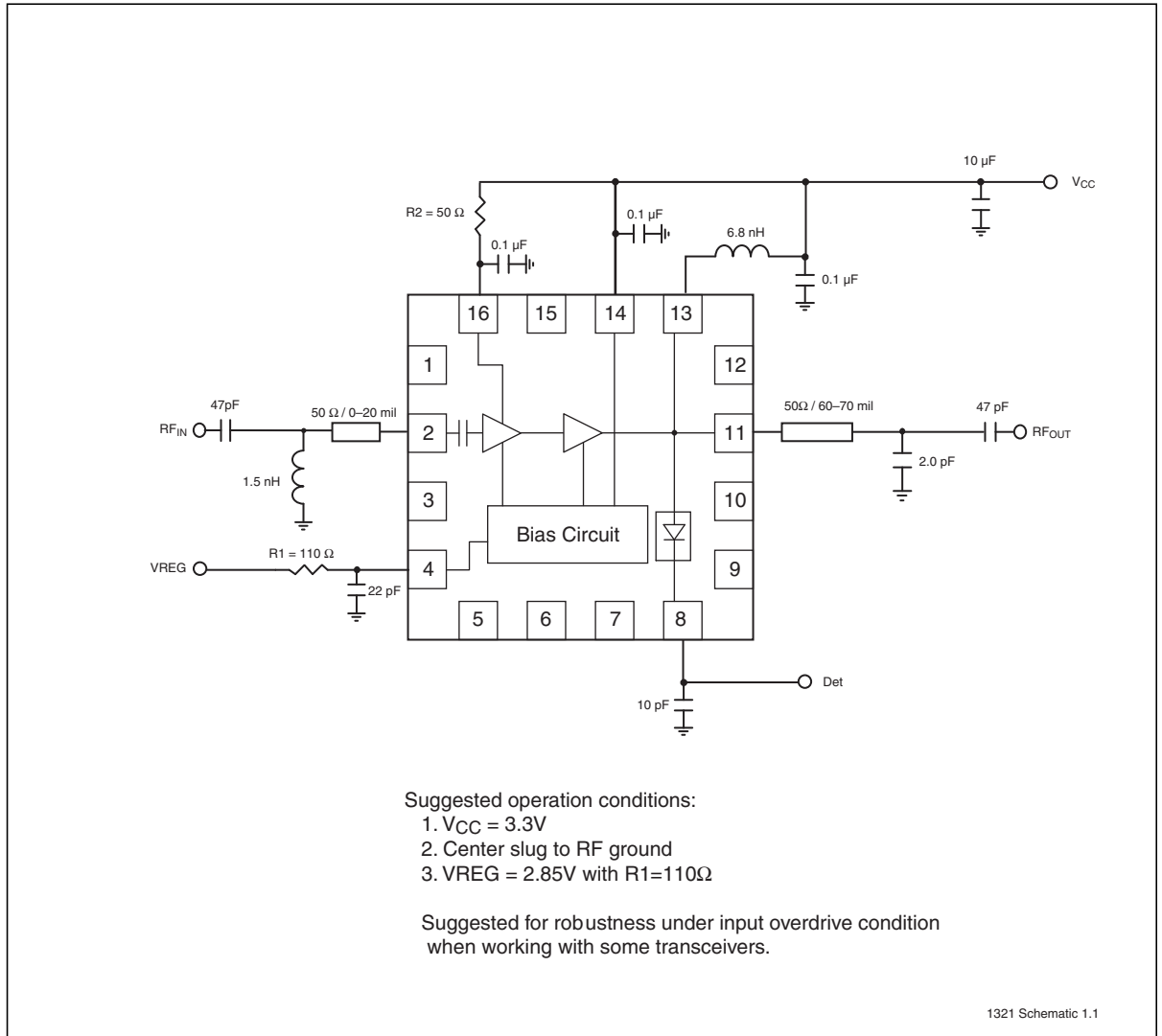

Figure 11: 802.11B Spectrum Mask at 22 dBm



# 2.4 GHz High-Power, High-Gain Power Amplifier SST12LP07



**Figure 12:** Typical Schematic for High-Power/High-Efficiency 802.11b/g Applications



### Product Ordering Information

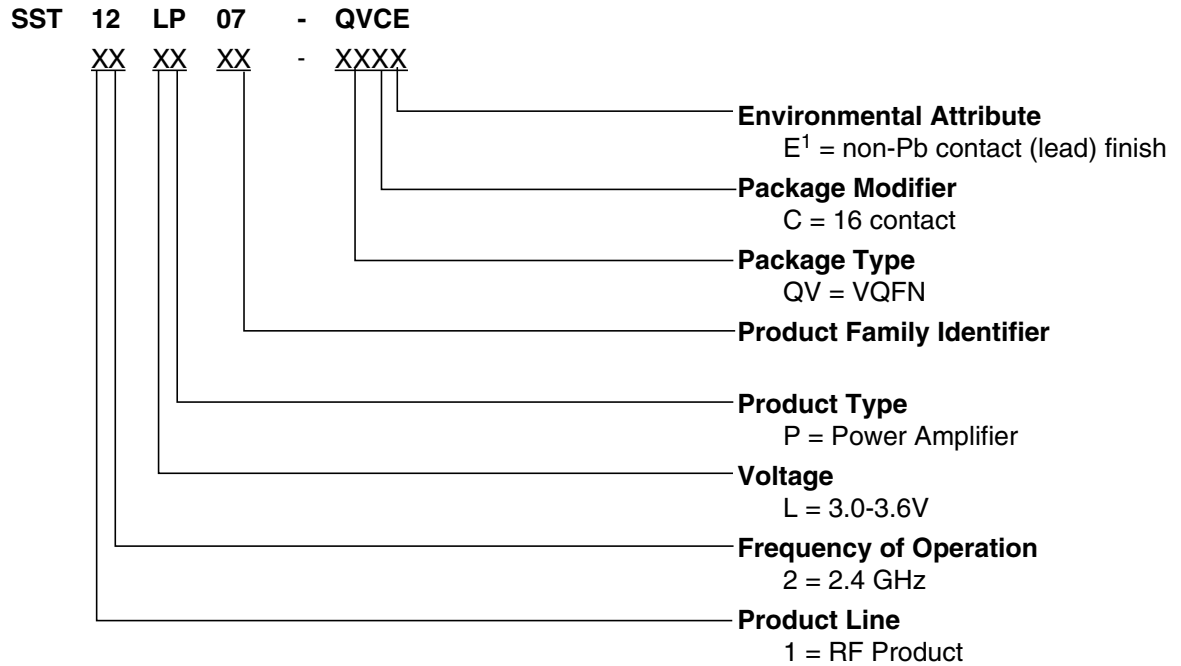

1. Environmental suffix "E" denotes non-Pb solder. SST non-Pb solder devices are "RoHS Compliant".

### Valid combinations for SST12LP07

SST12LP07-QVCE

### SST12LP07 Evaluation Kits

SST12LP07-QVCE-K

**Note:** Valid combinations are those products in mass production or will be in mass production. Consult your SST sales representative to confirm availability of valid combinations and to determine availability of new combinations.



### Packaging Diagrams

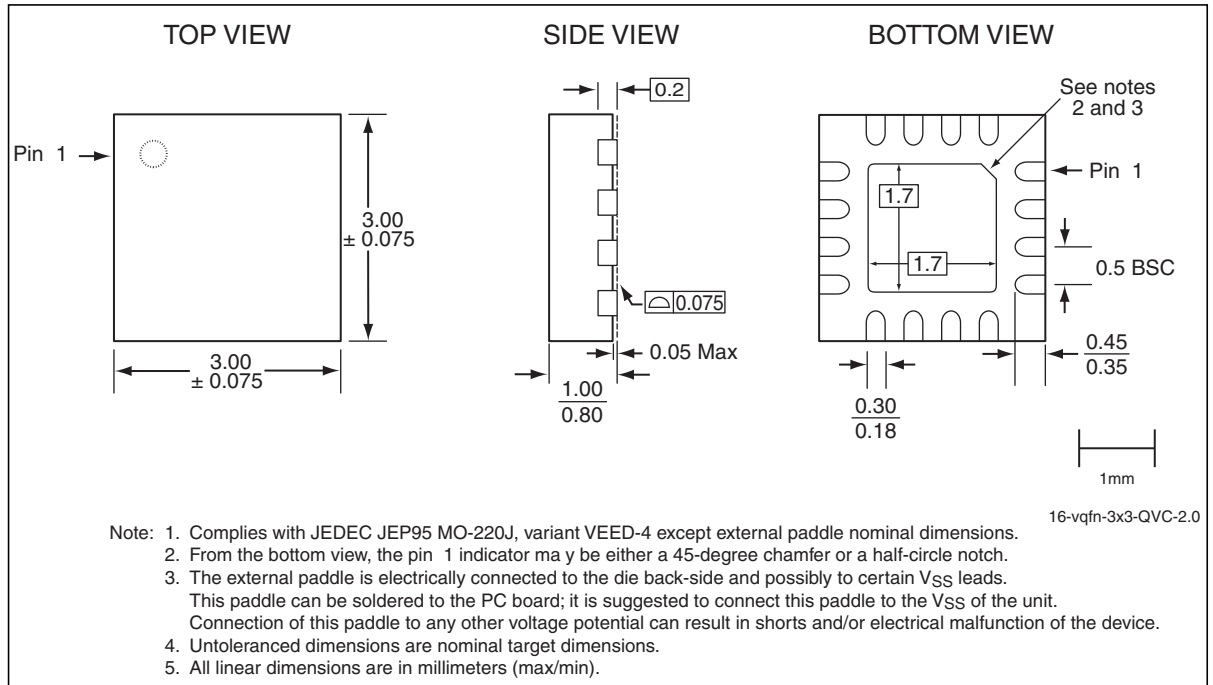

**Figure 13: 16-contact Very-thin Quad Flat No-lead (VQFN)**  
SST Package Code: QVC



# 2.4 GHz High-Power, High-Gain Power Amplifier

## SST12LP07

**Table 5:**Revision History

Revision	Description	Date
00	<ul style="list-style-type: none"> <li>Initial release of data sheet</li> </ul>	May 2006
01	<ul style="list-style-type: none"> <li>Updated document status from Preliminary Specifications to Data Sheet</li> </ul>	Mar 2008
02	<ul style="list-style-type: none"> <li>Updated "Contact Information" on page 14</li> </ul>	Mar 2009
A	<ul style="list-style-type: none"> <li>Applied new document format</li> <li>Released document under letter revision system</li> <li>Updated spec number from S71321 to DS75033</li> </ul>	Oct 2011

ISBN:978-1-61341-701-0

© 2011 Silicon Storage Technology, Inc—a Microchip Technology Company. All rights reserved.

SST, Silicon Storage Technology, the SST logo, SuperFlash, MTP, and FlashFlex are registered trademarks of Silicon Storage Technology, Inc. MPF, SQI, Serial Quad I/O, and Z-Scale are trademarks of Silicon Storage Technology, Inc. All other trademarks and registered trademarks mentioned herein are the property of their respective owners.

Specifications are subject to change without notice. Refer to [www.microchip.com](http://www.microchip.com) for the most recent documentation. For the most current package drawings, please see the Packaging Specification located at <http://www.microchip.com/packaging>.

Memory sizes denote raw storage capacity; actual usable capacity may be less.

SST makes no warranty for the use of its products other than those expressly contained in the Standard Terms and Conditions of Sale.

For sales office locations and information, please see [www.microchip.com](http://www.microchip.com).

---

Silicon Storage Technology, Inc.  
A Microchip Technology Company  
[www.microchip.com](http://www.microchip.com)

---