

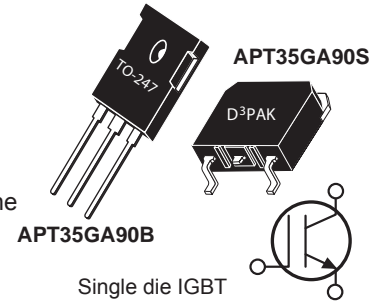

## High Speed PT IGBT

POWER MOS 8® is a high speed Punch-Through switch-mode IGBT. Low  $E_{off}$  is achieved through leading technology silicon design and lifetime control processes. A reduced  $E_{off} - V_{CE(ON)}$  tradeoff results in superior efficiency compared to other IGBT technologies. Low gate charge and a greatly reduced ratio of  $C_{res}/C_{ies}$  provide excellent noise immunity, short delay times and simple gate drive. The intrinsic chip gate resistance and capacitance of the poly-silicone gate structure help control di/dt during switching, resulting in low EMI, even when switching at high frequency.



### FEATURES

- Fast switching with low EMI
- Very Low  $E_{off}$  for maximum efficiency
- Ultra low  $C_{res}$  for improved noise immunity
- Low conduction loss
- Low gate charge
- Increased intrinsic gate resistance for low EMI
- RoHS compliant 

### TYPICAL APPLICATIONS

- ZVS phase shifted and other full bridge
- Half bridge
- High power PFC boost
- Welding
- UPS, solar, and other inverters
- High frequency, high efficiency industrial

### Absolute Maximum Ratings

Symbol	Parameter	Ratings	Unit
$V_{ces}$	Collector Emitter Voltage	900	V
$I_{C1}$	Continuous Collector Current @ $T_c = 25^\circ\text{C}$	63	A
$I_{C2}$	Continuous Collector Current @ $T_c = 100^\circ\text{C}$	35	
$I_{CM}$	Pulsed Collector Current <sup>1</sup>	105	
$V_{GE}$	Gate-Emitter Voltage <sup>2</sup>	±30	V
$P_D$	Total Power Dissipation @ $T_c = 25^\circ\text{C}$	290	W
SSOA	Switching Safe Operating Area @ $T_j = 150^\circ\text{C}$	105A @ 900V	
$T_J, T_{STG}$	Operating and Storage Junction Temperature Range	-55 to 150	°C
$T_J$	Lead Temperature for Soldering: 0.063" from Case for 10 Seconds	300	

### Static Characteristics

$T_J = 25^\circ\text{C}$  unless otherwise specified

Symbol	Parameter	Test Conditions	Min	Typ	Max	Unit
$V_{BR(CE)}$	Collector-Emitter Breakdown Voltage	$V_{GE} = 0V, I_C = 1.0mA$	900			V
$V_{CE(on)}$	Collector-Emitter On Voltage	$V_{GE} = 15V, I_C = 18A$ $T_J = 25^\circ\text{C}$ $T_J = 125^\circ\text{C}$		2.5 2.2	3.1	
$V_{GE(th)}$	Gate Emitter Threshold Voltage	$V_{GE} = V_{CE}, I_C = 1mA$	3	4.5	6	
$I_{CES}$	Zero Gate Voltage Collector Current	$V_{CE} = 900V, V_{GE} = 0V$ $T_J = 25^\circ\text{C}$ $T_J = 125^\circ\text{C}$			250 1000	µA
$I_{GES}$	Gate-Emitter Leakage Current	$V_{GS} = \pm 30V$			±100	nA

### Thermal and Mechanical Characteristics

Symbol	Characteristic	Min	Typ	Max	Unit
$R_{\theta JC}$	Junction to Case Thermal Resistance	-	-	0.43	°C/W
$W_T$	Package Weight	-	5.9	-	g
Torque	Mounting Torque (TO-247 Package), 4-40 or M3 screw			10	in·lbf

Dynamic Characteristics

T<sub>J</sub> = 25°C unless otherwise specified

APT35GA90B\_S

Symbol	Parameter	Test Conditions	Min	Typ	Max	Unit
C <sub>ies</sub>	Input Capacitance	Capacitance V <sub>GE</sub> = 0V, V <sub>CE</sub> = 25V f = 1MHz		1934		pF
C <sub>oes</sub>	Output Capacitance			173		
C <sub>res</sub>	Reverse Transfer Capacitance			28		
Q <sub>g</sub> <sup>3</sup>	Total Gate Charge	Gate Charge V <sub>GE</sub> = 15V V <sub>CE</sub> = 450V I <sub>C</sub> = 18A		84		nC
Q <sub>ge</sub>	Gate-Emitter Charge			14		
Q <sub>gc</sub>	Gate- Collector Charge			34		
SSOA	Switching Safe Operating Area	T <sub>J</sub> = 150°C, R <sub>G</sub> = 10Ω <sup>4</sup> , V <sub>GE</sub> = 15V, L = 100uH, V <sub>CE</sub> = 900V	105			A
t <sub>d(on)</sub>	Turn-On Delay Time	Inductive Switching (25°C) V <sub>CC</sub> = 600V V <sub>GE</sub> = 15V I <sub>C</sub> = 18A R <sub>G</sub> = 10Ω <sup>4</sup> T <sub>J</sub> = +25°C		12		ns
t <sub>r</sub>	Current Rise Time			15		
t <sub>d(off)</sub>	Turn-Off Delay Time			104		
t <sub>f</sub>	Current Fall Time			86		
E <sub>on2</sub>	Turn-On Switching Energy			642		
E <sub>off</sub> <sup>6</sup>	Turn-Off Switching Energy			382		
t <sub>d(on)</sub>	Turn-On Delay Time	Inductive Switching (125°C) V <sub>CC</sub> = 600V V <sub>GE</sub> = 15V I <sub>C</sub> = 18A R <sub>G</sub> = 10Ω <sup>4</sup> T <sub>J</sub> = +125°C		11		ns
t <sub>r</sub>	Current Rise Time			14		
t <sub>d(off)</sub>	Turn-Off Delay Time			154		
t <sub>f</sub>	Current Fall Time			144		
E <sub>on2</sub>	Turn-On Switching Energy			1044		
E <sub>off</sub> <sup>6</sup>	Turn-Off Switching Energy			907		

1 Repetitive Rating: Pulse width and case temperature limited by maximum junction temperature.

2 Pulse test: Pulse Width < 380μs, duty cycle < 2%.

3 See Mil-Std-750 Method 3471.

4 R<sub>G</sub> is external gate resistance, not including internal gate resistance or gate driver impedance. (MIC4452)

5 E<sub>on2</sub> is the clamped inductive turn on energy that includes a commutating diode reverse recovery current in the IGBT turn on energy loss. A combi device is used for the clamping diode.

6 E<sub>off</sub> is the clamped inductive turn-off energy measured in accordance with JEDEC standard JESD24-1.

Microsemi reserves the right to change, without notice, the specifications and information contained herein.

# Typical Performance Curves

APT35GA90B\_S

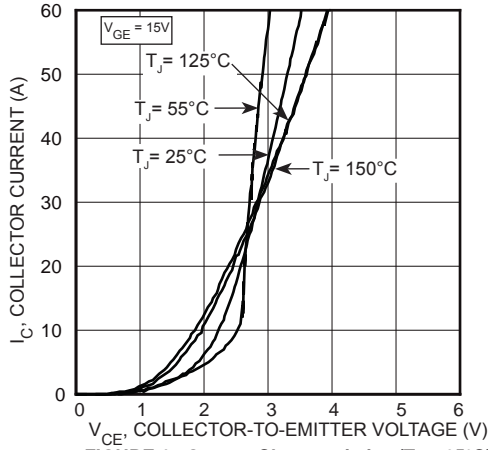

FIGURE 1, Output Characteristics ( $T_J = 25^\circ\text{C}$ )

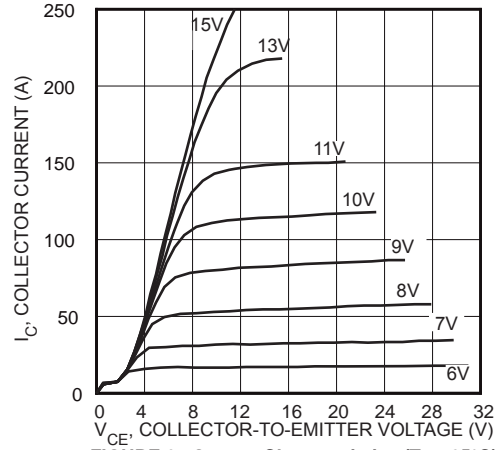

FIGURE 2, Output Characteristics ( $T_J = 25^\circ\text{C}$ )

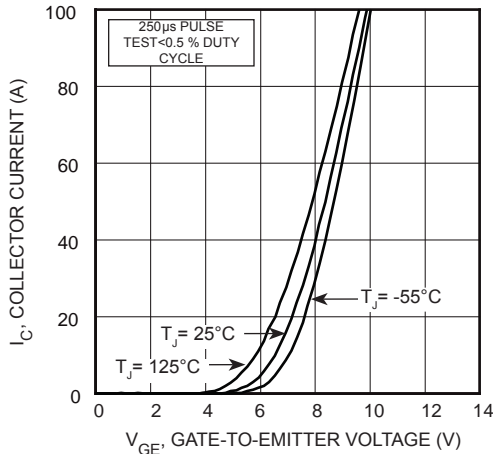

FIGURE 3, Transfer Characteristics

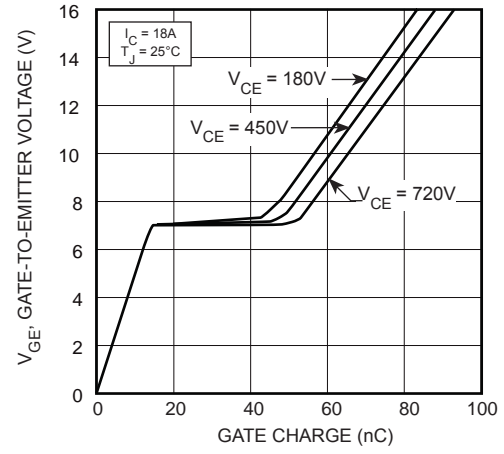

FIGURE 4, Gate charge

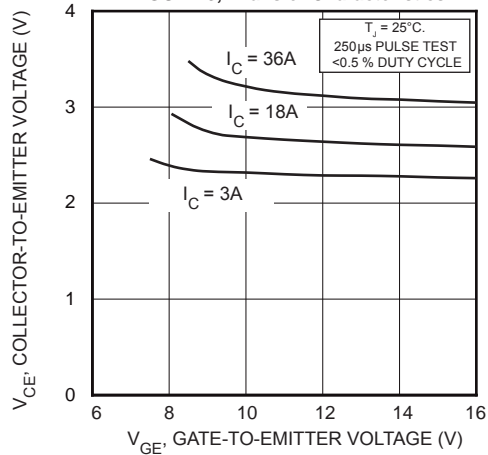

FIGURE 5, On State Voltage vs Gate-to-Emitter Voltage

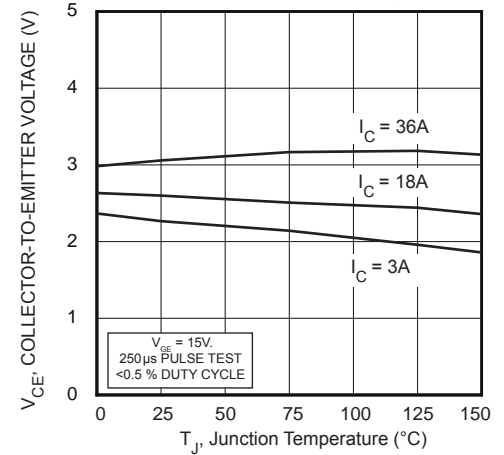

FIGURE 6, On State Voltage vs Junction Temperature

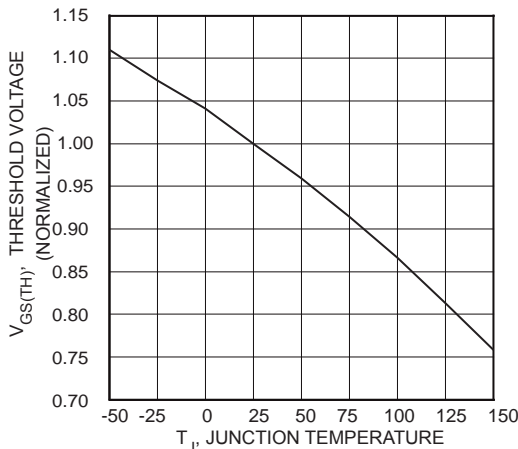

FIGURE 7, Threshold Voltage vs Junction Temperature

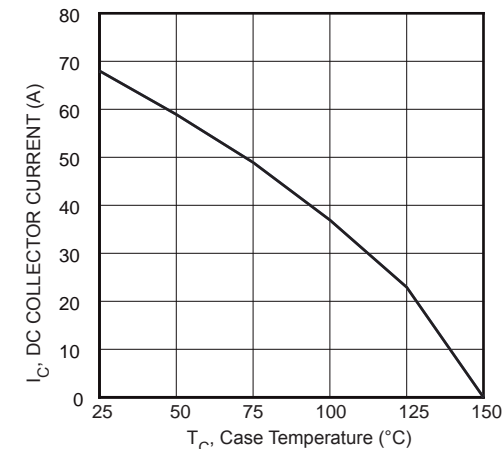

FIGURE 8, DC Collector Current vs Case Temperature

# Typical Performance Curves

APT35GA90B\_S

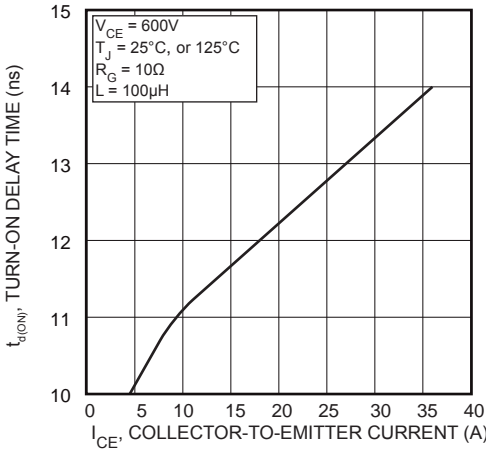

FIGURE 9, Turn-On Delay Time vs Collector Current

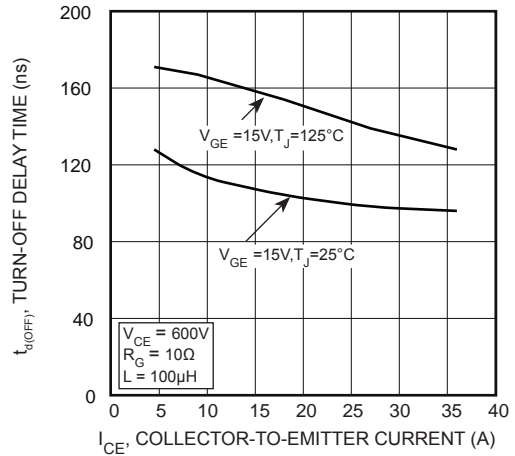

FIGURE 10, Turn-Off Delay Time vs Collector Current

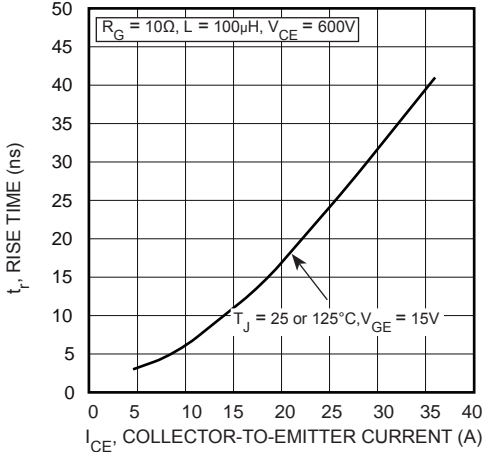

FIGURE 11, Current Rise Time vs Collector Current

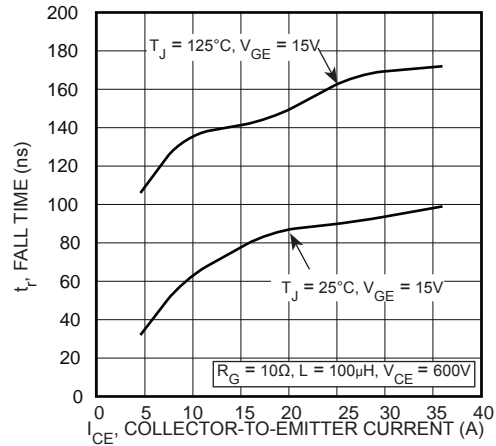

FIGURE 12, Current Fall Time vs Collector Current

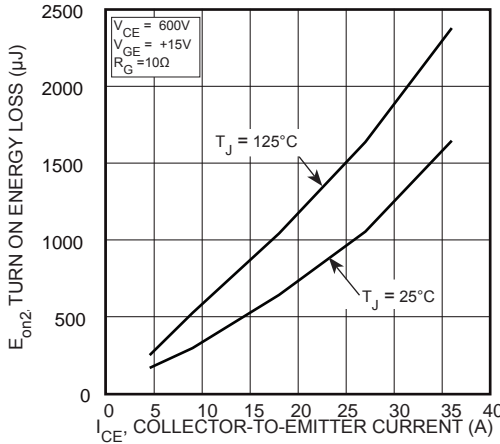

FIGURE 13, Turn-On Energy Loss vs Collector Current

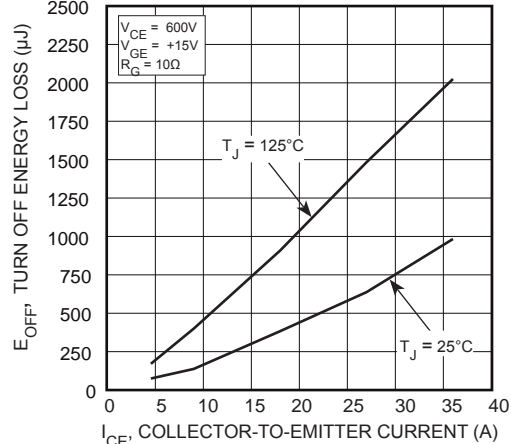

FIGURE 14, Turn-Off Energy Loss vs Collector Current

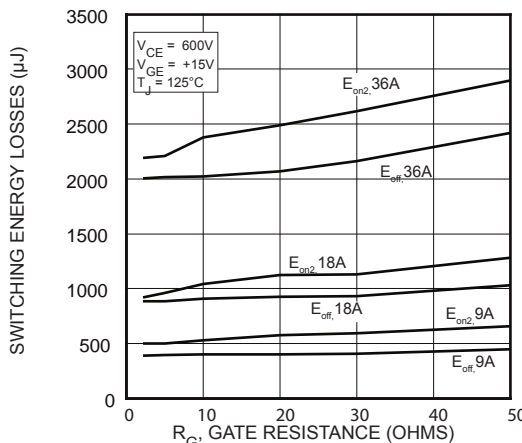

FIGURE 15, Switching Energy Losses vs Gate Resistance

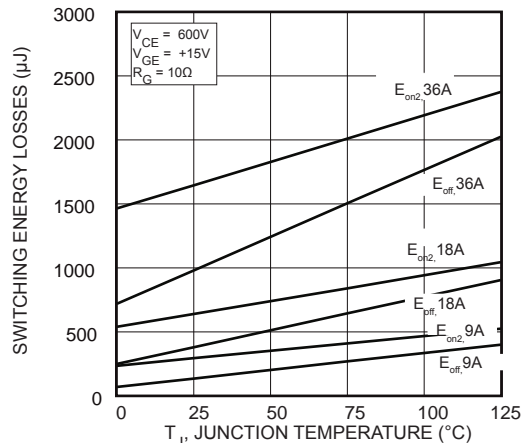

FIGURE 16, Switching Energy Losses vs Junction Temperature

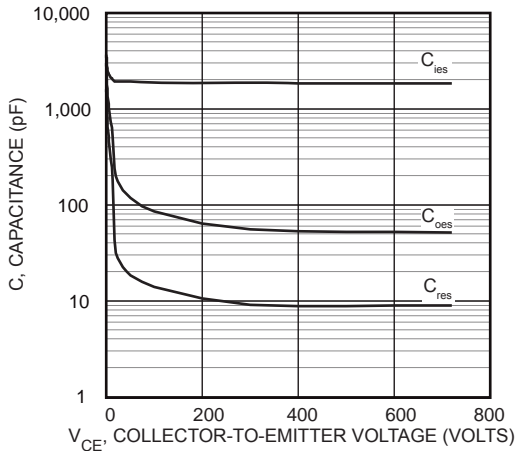

FIGURE 17, Capacitance vs Collector-To-Emitter Voltage

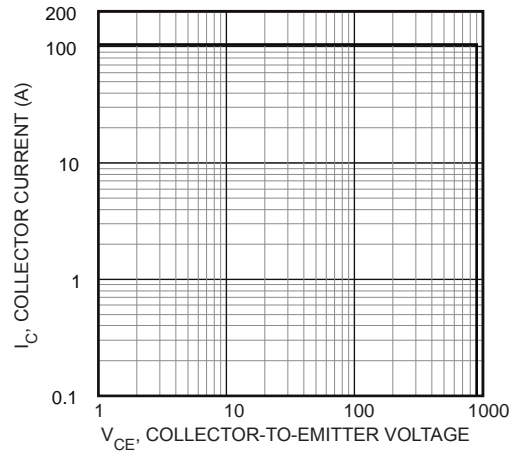

FIGURE 18, Minimum Switching Safe Operating Area

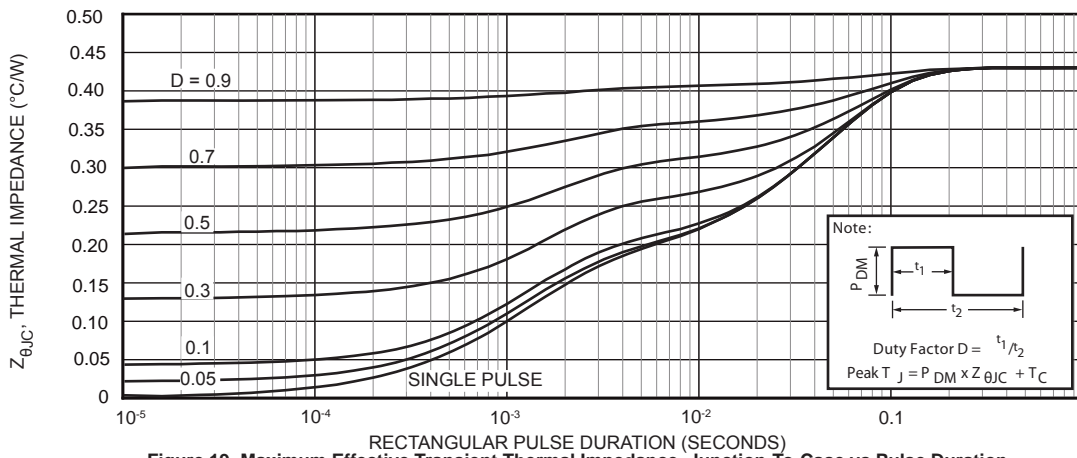

Figure 19, Maximum Effective Transient Thermal Impedance, Junction-To-Case vs Pulse Duration

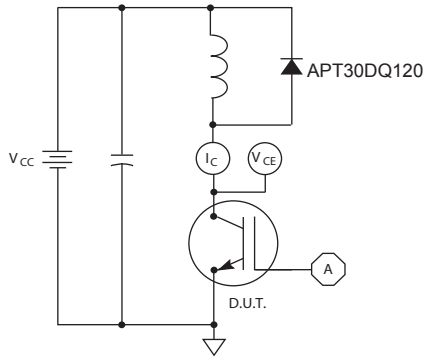

Figure 20, Inductive Switching Test Circuit

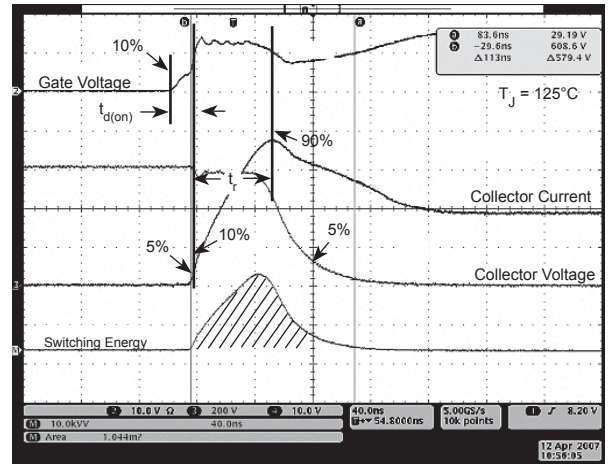

Figure 21, Turn-on Switching Waveforms and Definitions

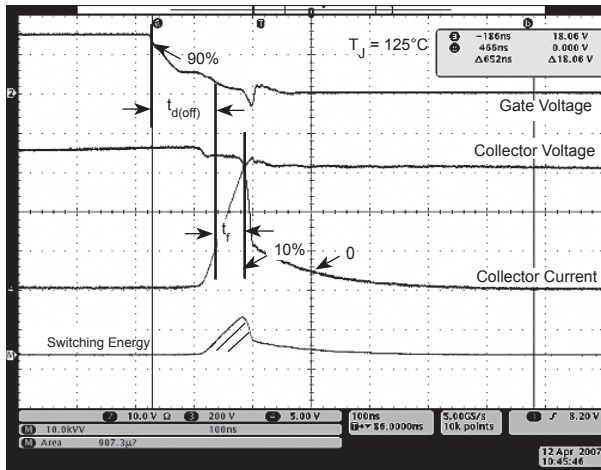
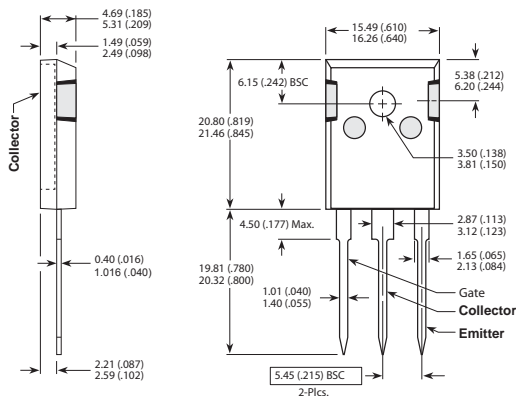

Figure 22, Turn-off Switching Waveforms and Definitions

### TO-247 Package Outline

Ⓔ1 SAC: Tin, Silver, Copper



Dimensions in Millimeters (Inches)

### D<sup>3</sup>PAK Package Outline

Ⓔ3 100% Sn Plated

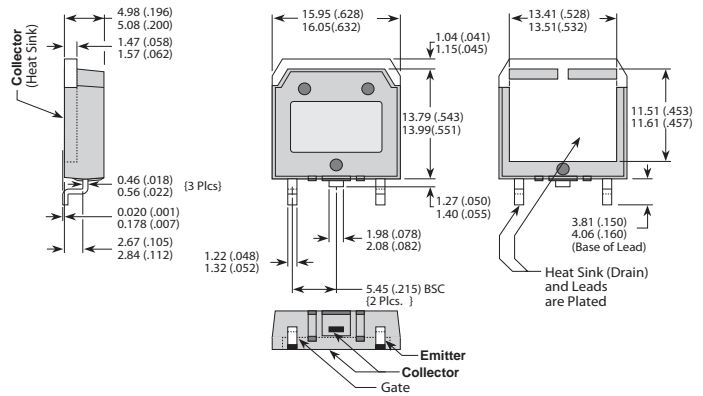

Dimensions in Millimeters (Inches)