



MICROCHIP

**MIC24045
Evaluation Kit
User's Guide**

Note the following details of the code protection feature on Microchip devices:

- Microchip products meet the specification contained in their particular Microchip Data Sheet.
- Microchip believes that its family of products is one of the most secure families of its kind on the market today, when used in the intended manner and under normal conditions.
- There are dishonest and possibly illegal methods used to breach the code protection feature. All of these methods, to our knowledge, require using the Microchip products in a manner outside the operating specifications contained in Microchip's Data Sheets. Most likely, the person doing so is engaged in theft of intellectual property.
- Microchip is willing to work with the customer who is concerned about the integrity of their code.
- Neither Microchip nor any other semiconductor manufacturer can guarantee the security of their code. Code protection does not mean that we are guaranteeing the product as "unbreakable."

Code protection is constantly evolving. We at Microchip are committed to continuously improving the code protection features of our products. Attempts to break Microchip's code protection feature may be a violation of the Digital Millennium Copyright Act. If such acts allow unauthorized access to your software or other copyrighted work, you may have a right to sue for relief under that Act.

Information contained in this publication regarding device applications and the like is provided only for your convenience and may be superseded by updates. It is your responsibility to ensure that your application meets with your specifications. MICROCHIP MAKES NO REPRESENTATIONS OR WARRANTIES OF ANY KIND WHETHER EXPRESS OR IMPLIED, WRITTEN OR ORAL, STATUTORY OR OTHERWISE, RELATED TO THE INFORMATION, INCLUDING BUT NOT LIMITED TO ITS CONDITION, QUALITY, PERFORMANCE, MERCHANTABILITY OR FITNESS FOR PURPOSE. Microchip disclaims all liability arising from this information and its use. Use of Microchip devices in life support and/or safety applications is entirely at the buyer's risk, and the buyer agrees to defend, indemnify and hold harmless Microchip from any and all damages, claims, suits, or expenses resulting from such use. No licenses are conveyed, implicitly or otherwise, under any Microchip intellectual property rights unless otherwise stated.

Microchip received ISO/TS-16949:2009 certification for its worldwide headquarters, design and wafer fabrication facilities in Chandler and Tempe, Arizona; Gresham, Oregon and design centers in California and India. The Company's quality system processes and procedures are for its PIC® MCUs and dsPIC® DSCs, KEELOQ® code hopping devices, Serial EEPROMs, microperipherals, nonvolatile memory and analog products. In addition, Microchip's quality system for the design and manufacture of development systems is ISO 9001:2000 certified.

**QUALITY MANAGEMENT SYSTEM
CERTIFIED BY DNV
= ISO/TS 16949 =**

Trademarks

The Microchip name and logo, the Microchip logo, AnyRate, dsPIC, FlashFlex, flexPWR, Heldo, JukeBlox, KeeLoq, KeeLoq logo, Klear, LANCheck, LINK MD, MediaLB, MOST, MOST logo, MPLAB, OptoLyzer, PIC, PICSTART, PIC32 logo, RightTouch, SpyNIC, SST, SST Logo, SuperFlash and UNI/O are registered trademarks of Microchip Technology Incorporated in the U.S.A. and other countries.

ClockWorks, The Embedded Control Solutions Company, ETHERSYNCH, Hyper Speed Control, HyperLight Load, IntelliMOS, mTouch, Precision Edge, and QUIET-WIRE are registered trademarks of Microchip Technology Incorporated in the U.S.A.

Analog-for-the-Digital Age, Any Capacitor, AnyIn, AnyOut, BodyCom, chipKIT, chipKIT logo, CodeGuard, dsPICDEM, dsPICDEM.net, Dynamic Average Matching, DAM, ECAN, EtherGREEN, In-Circuit Serial Programming, ICSP, Inter-Chip Connectivity, JitterBlocker, KlearNet, KlearNet logo, MiWi, motorBench, MPASM, MPF, MPLAB Certified logo, MPLIB, MPLINK, MultiTRAK, NetDetach, Omniscient Code Generation, PICDEM, PICDEM.net, PICKit, PICTail, PureSilicon, RightTouch logo, REAL ICE, Ripple Blocker, Serial Quad I/O, SQL, SuperSwitcher, SuperSwitcher II, Total Endurance, TSHARC, USBCheck, VariSense, ViewSpan, WiperLock, Wireless DNA, and ZENA are trademarks of Microchip Technology Incorporated in the U.S.A. and other countries.

SQTP is a service mark of Microchip Technology Incorporated in the U.S.A.

Silicon Storage Technology is a registered trademark of Microchip Technology Inc. in other countries.

GettIC is a registered trademarks of Microchip Technology Germany II GmbH & Co. KG, a subsidiary of Microchip Technology Inc., in other countries.

All other trademarks mentioned herein are property of their respective companies.

© 2016, Microchip Technology Incorporated, Printed in the U.S.A., All Rights Reserved.

ISBN: 978-1-5224-0638-9

Object of Declaration: MIC24045 Evaluation Kit

EU Declaration of Conformity

Manufacturer: Microchip Technology Inc.
2355 W. Chandler Blvd.
Chandler, Arizona, 85224-6199
USA

This declaration of conformity is issued by the manufacturer.

The development/evaluation tool is designed to be used for research and development in a laboratory environment. This development/evaluation tool is not a Finished Appliance, nor is it intended for incorporation into Finished Appliances that are made commercially available as single functional units to end users under EU EMC Directive 2004/108/EC and as supported by the European Commission's Guide for the EMC Directive 2004/108/EC (8th February 2010).

This development/evaluation tool complies with EU RoHS2 Directive 2011/65/EU.

This development/evaluation tool, when incorporating wireless and radio-telecom functionality, is in compliance with the essential requirement and other relevant provisions of the R&TTE Directive 1999/5/EC and the FCC rules as stated in the declaration of conformity provided in the module datasheet and the module product page available at www.microchip.com.

For information regarding the exclusive, limited warranties applicable to Microchip products, please see Microchip's standard terms and conditions of sale, which are printed on our sales documentation and available at www.microchip.com.

Signed for and on behalf of Microchip Technology Inc. at Chandler, Arizona, USA

Derek Carlson
VP Development Tools

12-Sep-14
Date

NOTES:

Table of Contents

Preface	7
Introduction.....	7
Document Layout	7
Conventions Used in this Guide	8
Recommended Reading.....	9
The Microchip Website.....	9
Customer Support	9
Document Revision History	9
 Chapter 1. Product Overview	
1.1 Introduction	11
1.2 MIC24045 Device Short Overview	11
1.3 MIC24045 Evaluation Board Overview	12
1.4 What the MIC24045 Evaluation Kit User's Guide Contains	12
 Chapter 2. Installation and Operation	
2.1 Introduction	13
2.2 Getting Started	13
2.3 On-Board Load Transient Generator	14
2.4 Loop Gain Measurement	14
 Chapter 3. GUI Installation and Operation	
3.1 Getting Started	15
3.1.1 Required Software	15
3.1.2 Required Hardware	15
3.2 Graphical User Interface Installation	15
3.3 I ² C Monitor Graphical User Interface Uninstall	18
 Chapter 4. GUI Description	
4.1 Introduction	19
4.2 The Graphical User Interface	20
4.2.1 Device Menu	20
4.2.2 I ² C Monitor Status and Control Bar	20
4.2.3 I ² C Generic Register View	20
4.2.4 MIC24045 I ² C Programmable Features	21
4.2.5 MIC24045 I ² C Diagnostic	22
4.2.6 MIC24045 Output Voltage Step	23
4.2.7 Status Bar	24

MIC24045 Evaluation Kit User's Guide

Appendix A. Schematic and Layouts

A.1 Introduction	25
A.2 Board – Schematic	26
A.3 Board – Top Copper and Silk	27
A.4 Board – Mid-Layer 1	28
A.5 Board – Mid-Layer 2	29
A.6 Board – Bottom Copper	30

Appendix B. Bill of Materials (BOM)31

Appendix C. MIC24045 Internal Registers

C.1 Registers Maps and I ² C Programmability	33
Table C-1: MIC24045 Register Map.....	33
C.1.1 Status Register	33

Worldwide Sales and Service38

Preface

NOTICE TO CUSTOMERS

All documentation becomes dated, and this manual is no exception. Microchip tools and documentation are constantly evolving to meet customer needs, so some actual dialogs and/or tool descriptions may differ from those in this document. Please refer to our website (www.microchip.com) to obtain the latest documentation available.

Documents are identified with a “DS” number. This number is located on the bottom of each page, in front of the page number. The numbering convention for the DS number is “DSXXXXXXXXA”, where “XXXXXXXX” is the document number and “A” is the revision level of the document.

For the most up-to-date information on development tools, see the MPLAB® IDE online help. Select the Help menu, and then Topics to open a list of available online help files.

INTRODUCTION

This chapter contains general information that will be useful to know before using the MIC24045 Evaluation Kit. Items discussed in this chapter include:

- [Document Layout](#)
- [Conventions Used in this Guide](#)
- [Recommended Reading](#)
- [The Microchip Website](#)
- [Customer Support](#)
- [Document Revision History](#)

DOCUMENT LAYOUT

This document describes how to use the MIC24045 Evaluation Kit as a development tool. The manual layout is as follows:

- **Chapter 1. “Product Overview”** – Important information about the MIC24045 Evaluation Kit.
- **Chapter 2. “Installation and Operation”** – Includes description and instructions on how to use the MIC24045 Evaluation Board.
- **Chapter 3. “GUI Installation and Operation”** – Includes Instructions on how to install the I²C Monitor Graphical User Interface.
- **Chapter 4. “GUI Description”** – Includes the description for I²C Monitor Graphical User Interface.
- **Appendix A. “Schematic and Layouts”** – Shows the schematic and layout diagrams for the MIC24045 Evaluation Board.
- **Appendix B. “Bill of Materials (BOM)”** – Lists the parts used to build the MIC24045 Evaluation Board.
- **Appendix C. “MIC24045 Internal Registers”** – Includes a detailed description of the available registers in the MIC24045 device.

MIC24045 Evaluation Kit User's Guide

CONVENTIONS USED IN THIS GUIDE

This manual uses the following documentation conventions:

DOCUMENTATION CONVENTIONS

Description	Represents	Examples
Arial font:		
Italic characters	Referenced books	<i>MPLAB[®] IDE User's Guide</i>
	Emphasized text	...is the <i>only</i> compiler...
Initial caps	A window	the Output window
	A dialog	the Settings dialog
	A menu selection	select Enable Programmer
Quotes	A field name in a window or dialog	"Save project before build"
Underlined, italic text with right angle bracket	A menu path	<u><i>File>Save</i></u>
Bold characters	A dialog button	Click OK
	A tab	Click the Power tab
N'Rnnnn	A number in verilog format, where N is the total number of digits, R is the radix and n is a digit.	4'b0010, 2'hF1
Text in angle brackets < >	A key on the keyboard	Press <Enter>, <F1>
Courier New font:		
Plain Courier New	Sample source code	#define START
	Filenames	autoexec.bat
	File paths	c:\mcc18\h
	Keywords	_asm, _endasm, static
	Command-line options	-Opa+, -Opa-
	Bit values	0, 1
	Constants	0xFF, 'A'
Italic Courier New	A variable argument	<i>file.o</i> , where <i>file</i> can be any valid filename
Square brackets []	Optional arguments	mcc18 [options] <i>file</i> [options]
Curly brackets and pipe character: { }	Choice of mutually exclusive arguments; an OR selection	errorlevel {0 1}
Ellipses...	Replaces repeated text	var_name [, var_name...]
	Represents code supplied by user	void main (void) { ... }

RECOMMENDED READING

This user's guide describes how to use the MIC24045 Evaluation Kit. Another useful document is listed below. The following Microchip document is available and recommended as a supplemental reference resource:

- **MIC24045 Data Sheet – “I²C Programmable, 4.5V-19V Input, 5A Step-Down Converter” (DS20005568).**

THE MICROCHIP WEBSITE

Microchip provides online support via our website at www.microchip.com. This website is used as a means to make files and information easily available to customers. Accessible by using your favorite Internet browser, the website contains the following information:

- **Product Support** – Data sheets and errata, application notes and sample programs, design resources, user's guides and hardware support documents, latest software releases and archived software
- **General Technical Support** – Frequently Asked Questions (FAQs), technical support requests, online discussion groups, Microchip consultant program member listing
- **Business of Microchip** – Product selector and ordering guides, latest Microchip press releases, listing of seminars and events, listings of Microchip sales offices, distributors and factory representatives

CUSTOMER SUPPORT

Users of Microchip products can receive assistance through several channels:

- Distributor or Representative
- Local Sales Office
- Field Application Engineer (FAE)
- Technical Support

Customers should contact their distributor, representative or field application engineer (FAE) for support. Local sales offices are also available to help customers. A listing of sales offices and locations is included in the back of this document.

Technical support is available through the website at:

<http://www.microchip.com/support>

DOCUMENT REVISION HISTORY

Revision A (June 2016)

- Initial release of this document.

MIC24045 Evaluation Kit User's Guide

NOTES:

Chapter 1. Product Overview

1.1 INTRODUCTION

This chapter provides an overview of the MIC24045 Evaluation Kit (ADM00764) and covers the following topics:

- MIC24045 Device Short Overview
- MIC24045 Evaluation Board Overview
- What the MIC24045 Evaluation Kit User's Guide Contains

1.2 MIC24045 DEVICE SHORT OVERVIEW

The MIC24045 is a I²C programmable, high-efficiency, wide-input range, 5A synchronous step-down regulator. The MIC24045 is perfectly suited for multiple voltage rail application environments found in enterprise computing and telecommunication systems. For the MIC24045 device, the user can program, via I²C, various parameters such as Output Voltage, Switching Frequency, Soft-Start slope, Margining, Current Limit values and Start-up Delay. The MIC24045 wide switching frequency adjustment range, valley current-mode control technique, high-performance error amplifier and external compensation allow the best trade offs between high-efficiency and small solution size. The MIC24045 device supports extensive diagnostics and status information through I²C. Programmable cycle-by-cycle current limit value helps optimizing the size of the inductor in each particular application.

The MIC24045 pin-out is compatible with the MIC24046 pin-strapping programmable regulators pin-out, such that I²C-based implementations can be seamlessly converted into pin-programmable ones.

The MIC24045 is available in thermally-efficient, space-saving 20-pin 3 mm x 3 mm FQFN package, with an operating junction temperature range from -40°C to +125°C.

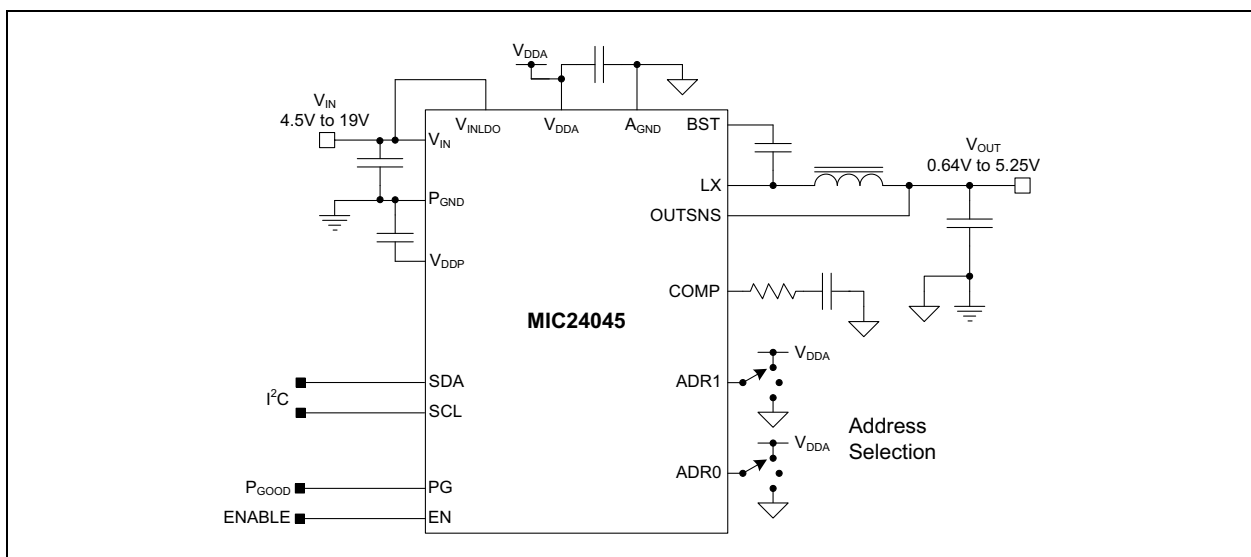

FIGURE 1-1: MIC24045 Typical Application.

1.3 MIC24045 EVALUATION BOARD OVERVIEW

The MIC24045 Evaluation Board is designed to serve all of the devices that make up Microchip's MIC2404x family of parts. As a result, only a subset of its features is needed for the MIC24045 evaluation.

Specific for the evaluation of the MIC24045 device, the V_{IN} supply ranges from 4.5V to 19V and output voltage from 0.64V to 5.25V in 5 mV, 10 mV, 30 mV and 50 mV steps at 5A. Additionally, an on-board load transient generator circuit and connections for loop gain measurements are provided. A connector (J10) matching the MCP2221 Breakout Module I²C interface is provided for board compatibility with I²C.

1.4 WHAT THE MIC24045 EVALUATION KIT USER'S GUIDE CONTAINS

The MIC24045 Evaluation Kit includes:

- MIC24045 Evaluation Board
- MCP2221 Breakout Module
- USB-to-mini-USB Cable
- Important Information Sheet

Chapter 2. Installation and Operation

2.1 INTRODUCTION

The MIC24045 Evaluation Board requires only a single power supply with at least 5A current capability. The MIC24045 has an internal V_{DDA} LDO, so no external linear regulator is required to power the internal biasing of the device.

2.2 GETTING STARTED

To power up the MIC24045 Evaluation Board, the following steps must be completed:

1. Connect a power supply to the VIN and GND_IN terminals. An ammeter may be placed between the input supply and the VIN terminal of the evaluation board. Ensure that the supply voltage is monitored at the VIN terminal (CON1 or J2). The ammeter and/or power lead resistance can reduce the voltage supplied to the input. Keep the power supply disabled; do not apply power until [Step 5](#).
2. Connect the load to the VOUT and GND_OUT terminals. The load can be either passive (resistive) or active (electronic load). An ammeter can be placed between the load and the VOUT terminal. Ensure that the output voltage is monitored at the VOUT terminal (CON5 or J1). Alternatively, for high-speed load transient testing at low output voltages, the on-board load transient generator can be used (see [Section 2.3 “On-Board Load Transient Generator”](#)).
3. Make sure that a jumper is connected on J18 and another jumper on J3, between VIN and VINLDO.
4. Connect the MCP2221 Breakout Module to the MIC24045 Evaluation Board (see [Figure 2-1](#)).



FIGURE 2-1: MIC24045 with MCP2221 Board Connection.

MIC24045 Evaluation Kit User's Guide

5. Turn on the power supply.
6. Make sure a jumper is connected on JP1 on the MCP2221 Breakout Module, on the 3.3V side.
7. To modify the Current Limit, Switching Frequency, Output Voltage, Soft Start time and other features of the part, use the I²C Monitor Graphical User Interface (for more details, see [Chapter 3. "GUI Installation and Operation"](#) and [Chapter 4. "GUI Description"](#)).
8. Using the **Enable** button in the GUI, turn on the converter.
9. Once **Enable** is turned on, the voltage set using the GUI should be present at the output of the converter.

2.3 ON-BOARD LOAD TRANSIENT GENERATOR

The MIC24045 Evaluation Board provides circuitry to enable load transient testing with fast current rise time and fast, yet controlled, fall time. This is done by a fast turn-on, controlled turn-off MOSFET switch (Q2). Resistive loads (R10 to R13) can be selectively connected by means of header J14. MOSFET Q2 must be driven by an external signal generator, connected at J21, using a square wave (suggested low level = 0V, high level = 5V-6V). Drive levels can be adjusted to modify the switching speed of Q2, but should always ensure complete turn-on and turn-off of Q2 after settling, while not exceeding its V_{GS} ratings. It is very important not to exceed the power dissipation limit of R10 to R13. Using 2512 resistors (1W rating), the constraint is (R_{LOAD} takes the values of R10 to R13):

EQUATION 2-1:

$$D \cdot \frac{V_{OUT}^2}{R_{LOAD}} < 1W$$

Where:

D = on time duty cycle of Q2

V_{OUT} = selected output voltage

R_{LOAD} = the value of resistors R10 to R13 (default board value is 1Ω)

The on-board load transient generator is especially useful when testing at very low output voltages, since not many active loads can perform well under those conditions, while current rise times, achievable with external load boards, are limited by stray inductance.

2.4 LOOP GAIN MEASUREMENT

The MIC24045 Evaluation Board provides injection points and a termination resistor for AC loop gain measurements. Inject the oscillator at J15 through the insulation transformer and connect the A (CH1) and B (CH2) channels at J17 and J16, respectively, or as indicated by the operating instructions of the particular loop gain analyzer in use.

Chapter 3. GUI Installation and Operation

3.1 GETTING STARTED

In order to install, use and evaluate the product, there are several software and hardware tools required to be installed and/or set.

3.1.1 Required Software

- I²C Monitor Graphical User Interface (v.1.0.0)
- Microsoft[®].NET Framework 4.5 or Higher
- Adobe[®] Acrobat[®] Reader[®]
- Microsoft[®] Windows[®] 7

3.1.2 Required Hardware

- MIC24045 Evaluation Board
- MCP2221 Breakout Module
- USB-to-mini-USB Cable

3.2 GRAPHICAL USER INTERFACE INSTALLATION

The following steps describe how to install the I²C Monitor Graphical User Interface:

1. If Microsoft .NET Framework is already installed, go to [Step 3](#). If not, download Microsoft .NET Framework from www.microsoft.com and follow the installation instructions.
2. If Adobe Reader is already installed, go to [Step 3](#). If not, download Adobe Reader from <http://get.adobe.com/reader/> and follow the installation instructions.
3. Download the I²C Monitor Graphical User Interface (v.1.0.0) archive from www.microchip.com/MIC24045, under "Documentation & Software".
4. Unzip the I²C Monitor Graphical User Interface archive, which contains the `setup.exe` file.

Note: If an older version or a corrupted version of the current I²C Monitor Graphical User Interface is already installed on the computer, please see [Section 3.3 "I²C Monitor Graphical User Interface Uninstall"](#) before proceeding with the installation.

5. Double click on the `setup.exe` file to open the InstallShield Wizard window and wait for the extraction to complete. If required, the installation can be stopped by pressing the **Cancel** button.

6. In the Welcome to the InstallShield Wizard for I2CMonitor window, click on the **Next** button to start the installation.

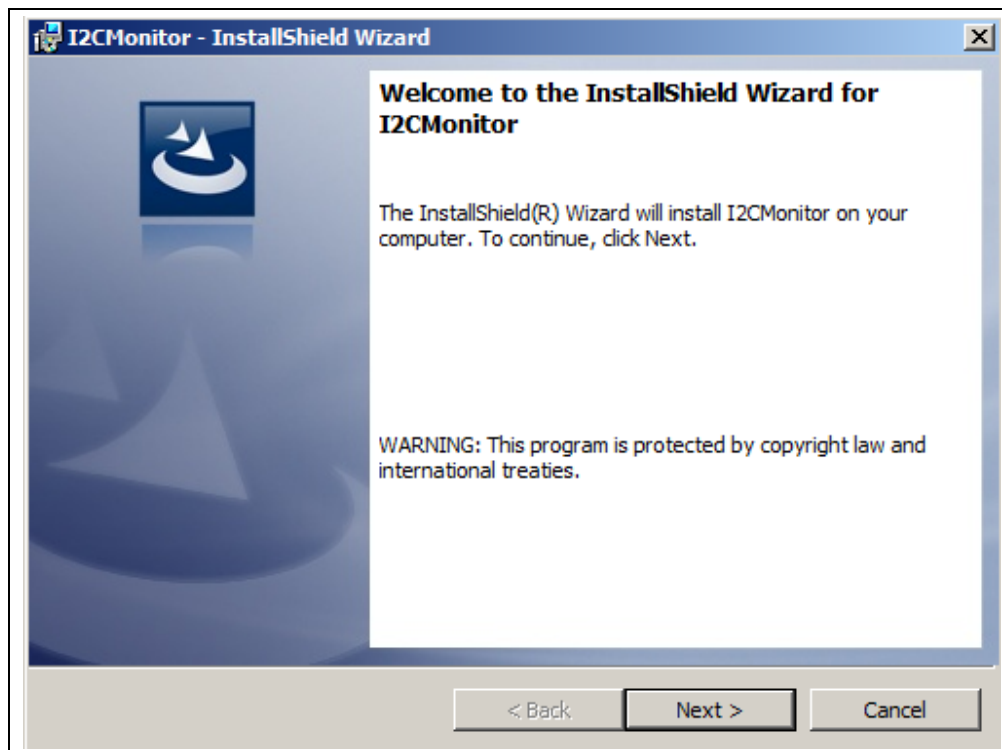

FIGURE 3-1: Starting the I²C Monitor Graphical User Interface Installation.

7. The installation path can be changed, although it is recommended to keep the default path. Click on the **Next** button to continue.

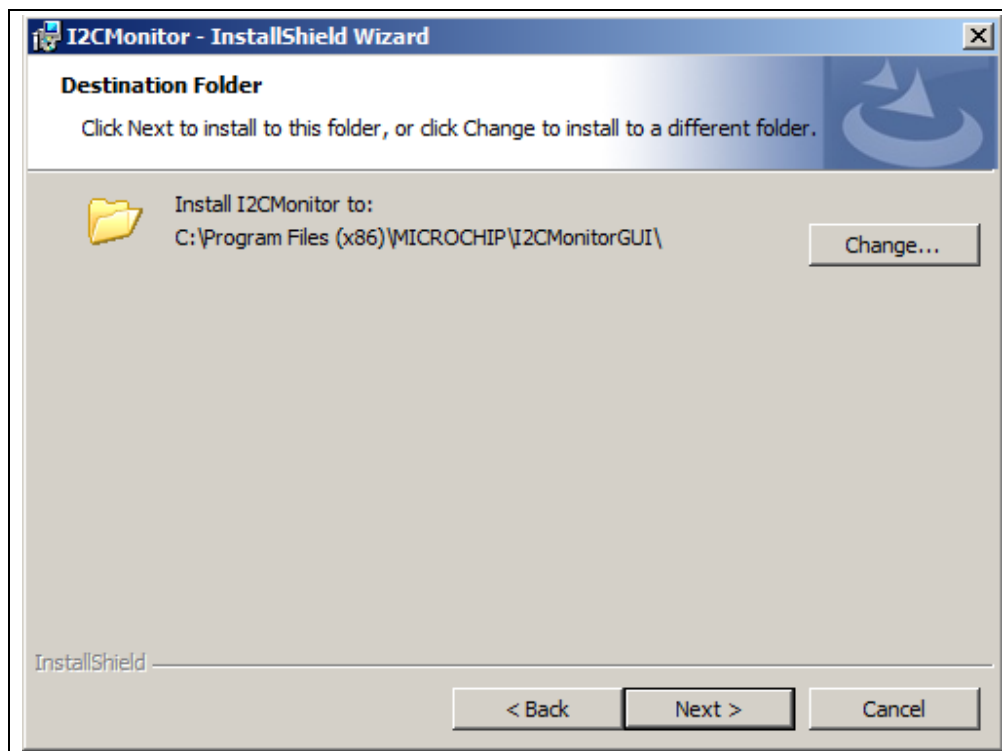

FIGURE 3-2: Selecting the Destination Folder.

8. In the Ready to Install the Program window, click on the **Install** button and wait for the application to proceed with the installation. The progress can be observed in the “Status” bar.

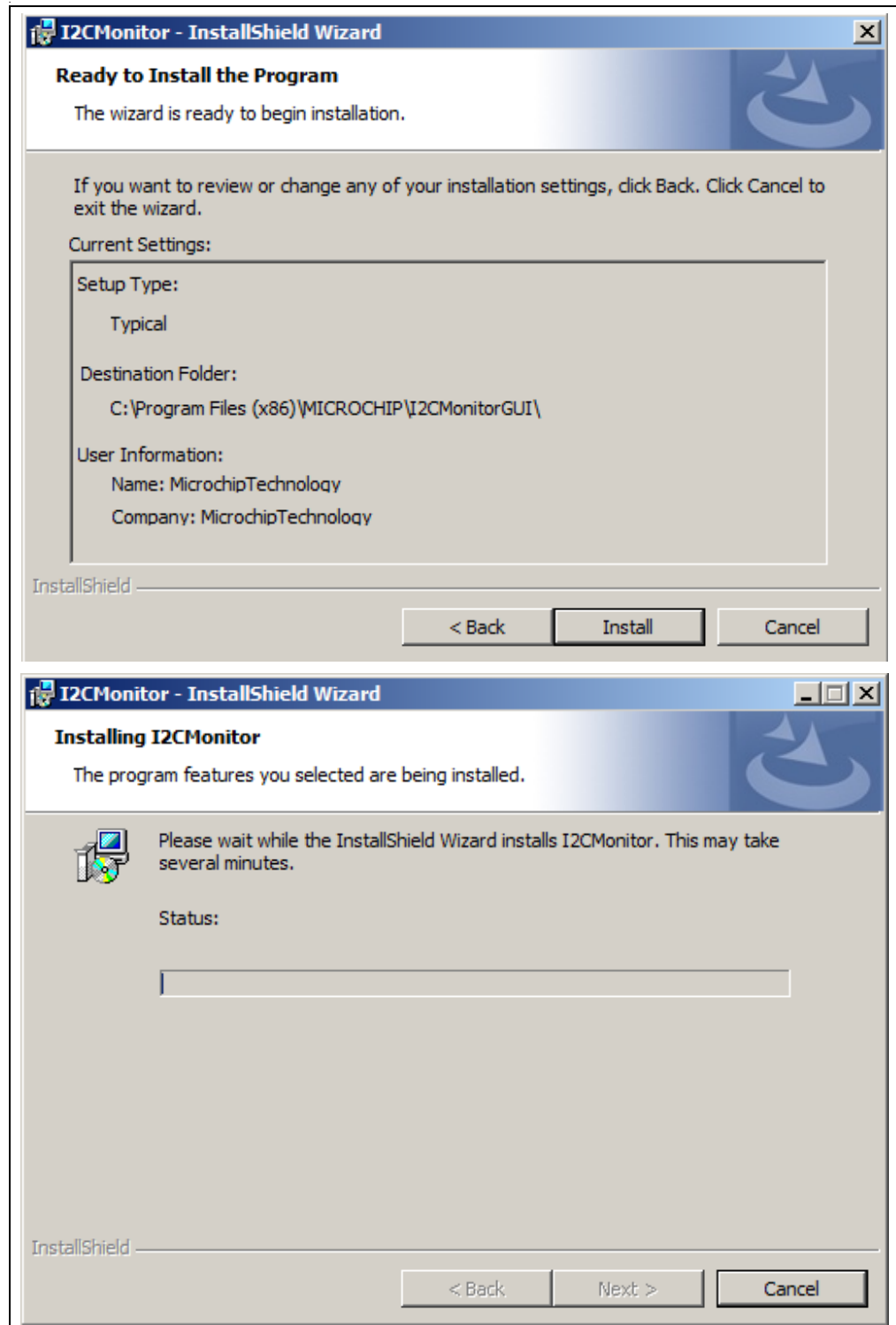

FIGURE 3-3: Installing the I²C Monitor Graphical User Interface.

9. Once the installation completes, leave the **Launch the program** box checked to automatically start the I²C Monitor GUI, or deselect this check box to start the GUI at a later stage. Click **Finish** to end the installation.

To start the GUI at a later stage, either click on the desktop icon or browse to *Windows Start>All Programs>Microchip>I2C Monitor*.

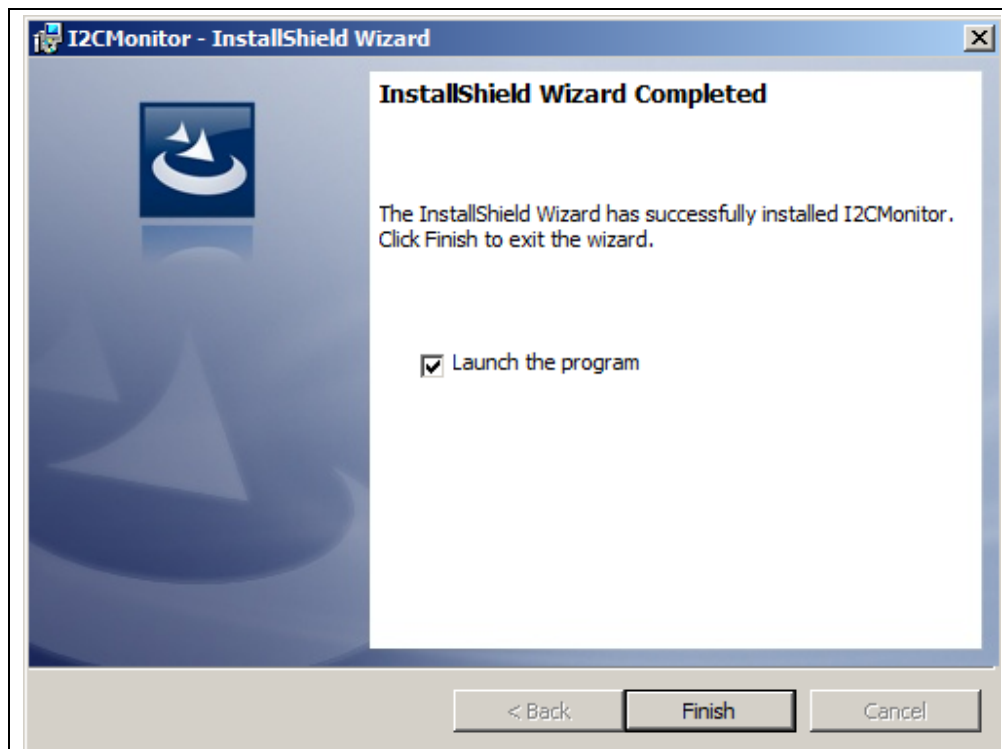

FIGURE 3-4: The Installation Complete Window.

3.3 I²C MONITOR GRAPHICAL USER INTERFACE UNINSTALL

In order to install a new version of the I²C Monitor Graphical User Interface, any previous version or corrupted version should be removed from the computer.

To uninstall, go to *Windows Start>Control Panel>Uninstall a program>I2CMonitor*. The I²C Monitor GUI will automatically close once the uninstallation process is complete.

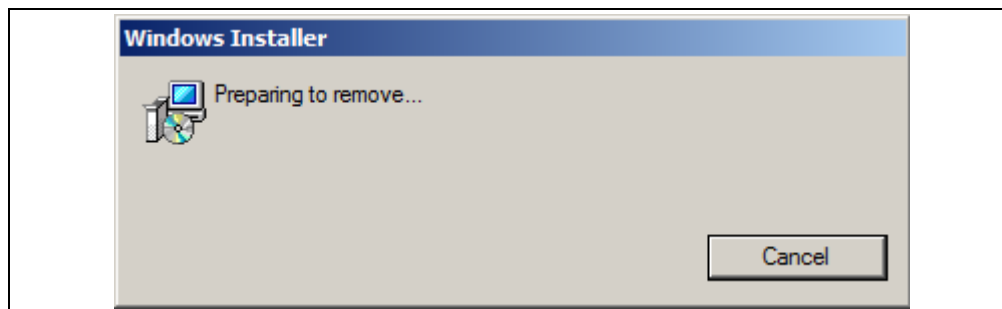

FIGURE 3-5: Uninstalling the I²C Monitor Graphical User Interface.

Chapter 4. GUI Description

4.1 INTRODUCTION

This chapter describes how to use the I²C Monitor Graphical User Interface, using the MIC24045 Evaluation Board included in the kit.

NOTICE

This chapter provides information regarding the use of the GUI only in the case of the MIC24045 device. For other devices using the I²C Monitor Graphical User Interface, see their specific Data Sheets and User's Guides.

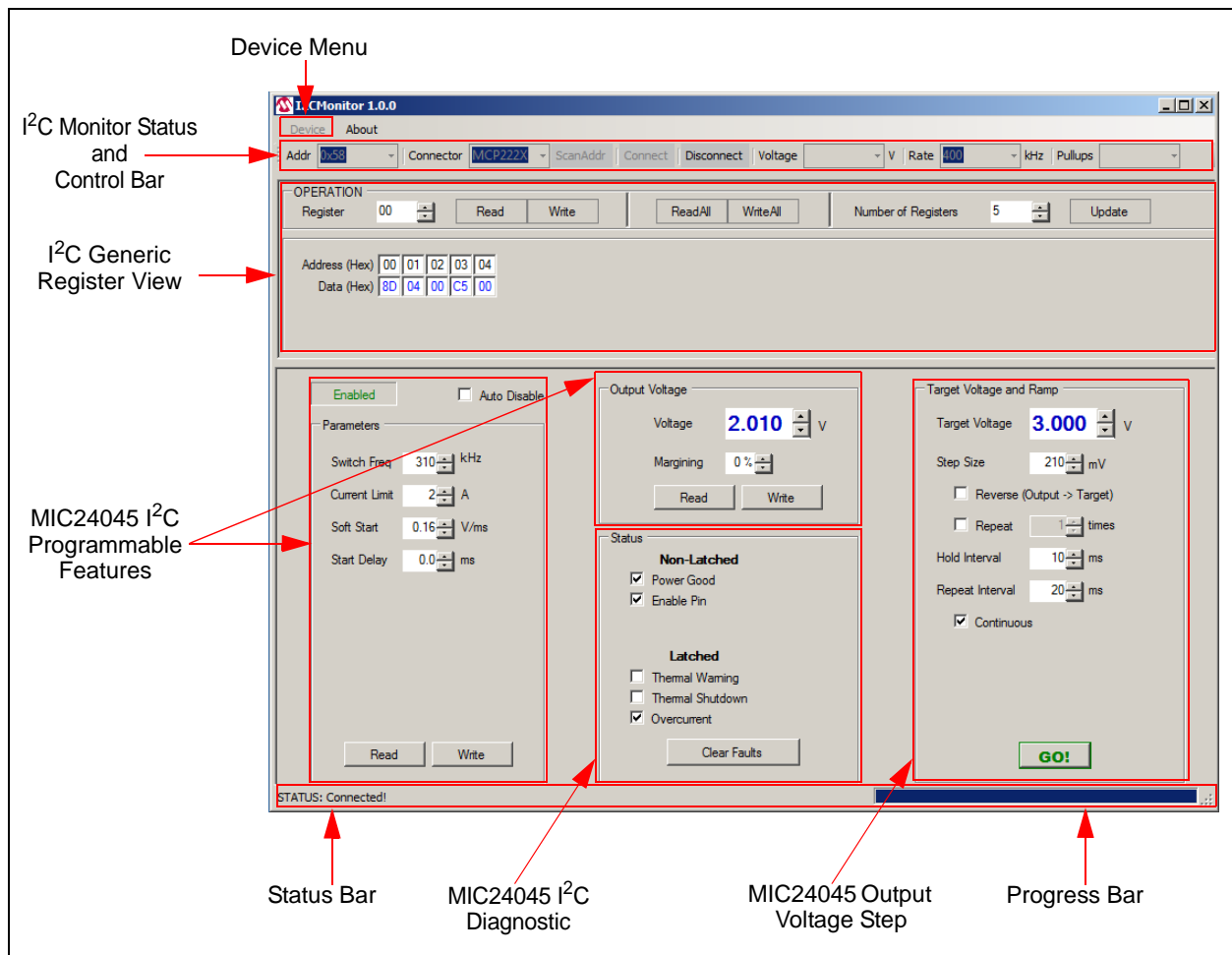

FIGURE 4-1: I²C Monitor Graphical User Interface Main Window - MIC24045 View.

4.2 THE GRAPHICAL USER INTERFACE

The following sections describe the items in the Graphical User Interface.

4.2.1 Device Menu

The Device drop-down menu allows the user to select the device to be evaluated.

4.2.2 I²C Monitor Status and Control Bar

The status and control bar contains the items in [Table 4-1](#).

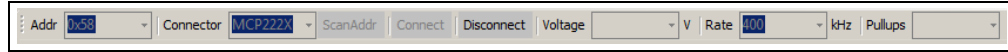

FIGURE 4-2: I²C Monitor Status and Control Bar.

TABLE 4-1: MONITOR STATUS AND CONTROL BAR

Item	Description
Addr	This drop-down menu shows the address of the available devices.
Connector	This drop-down menu shows the type of connector used to connect the board.
ScanAddr	This button is used to scan for a valid address.
Connect/Disconnect	These buttons are used to connect/disconnect the current selected device.
Voltage	This drop-down menu is used to select the voltage level of the communication when using Pickit Serial Analyzer.
Rate	This drop-down menu is used to select the corresponding communication rate for the device.
Pullups	This drop-down menu is used to activate the internal pullups from the Pickit Serial Analyzer.

In the Status and Control bar the user can choose the hardware tool for the communication with the device and the settings it should allow.

In order to connect to a device, the user must follow [Steps 1 - 3](#) as described in [Section 2.2 “Getting Started”](#). After connecting the MCP2221 Breakout Module, the user must scan for a valid address. Once a valid address is detected, clicking the **Connect** button will initialize the connection with the device and the registers will be available for read and write operations.

4.2.3 I²C Generic Register View

The I²C Generic Register View area contains the items in [Table 4-2](#). This section of the I²C Monitor GUI is common for any device evaluated.

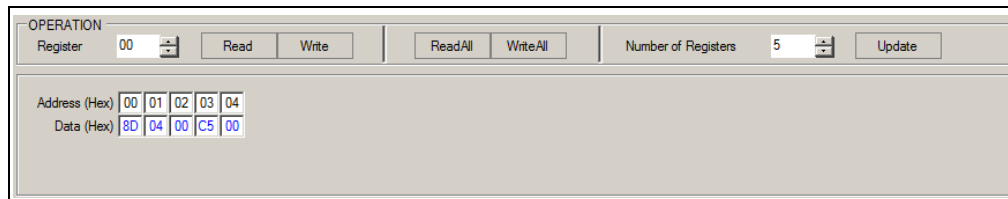

FIGURE 4-3: Generic Register View Area.

TABLE 4-2: I²C GENERIC REGISTER VIEW ITEMS

Panel	Item	Description
Operation	Register	This section shows the registers available for read/write operations.
	Read/Write	These buttons are used for single register read/write operations.
	ReadAll/WriteAll	These button are used for reading/writing all the available registers.
	Number of Registers	In this section, the user can set the number of available registers for read/write operations.
	Update	This button sets the number of available registers for read/write operations in the Register area.
Register Area		This section shows the current status of the address of the registers and their content.

The specific registers for MIC24045 device are described in [Appendix C. “MIC24045 Internal Registers”](#).

4.2.4 MIC24045 I²C Programmable Features

The MIC24045 I²C Programmable Features area contains the items in [Table 4-3](#).

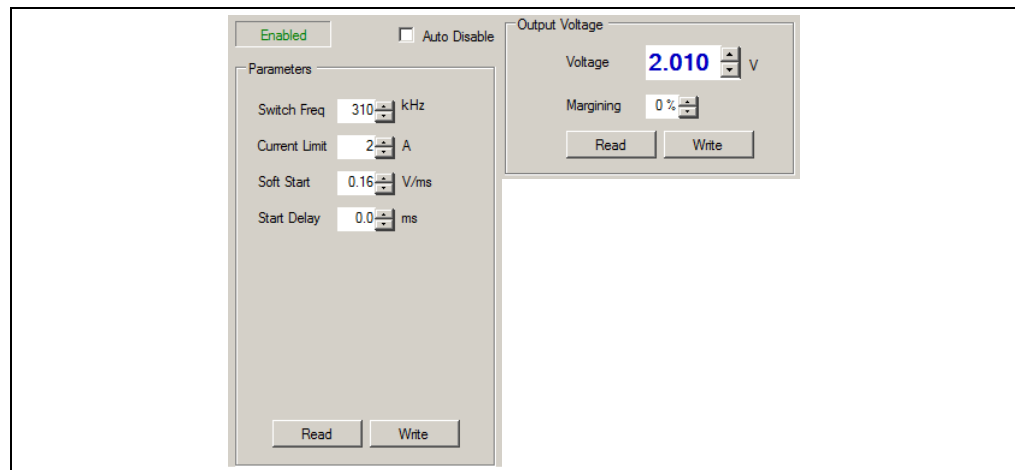

FIGURE 4-4: MIC24045 I²C Programmable Features Area.

TABLE 4-3: MIC24045 I²C Programmable Features

Panel/Button	Items	Description
Enable		This button controls the Enable pin of the MIC24045 when a header is connected on J18. The red color of this button marks the Off state and green marks the On state.
Auto Disable		If this option is checked, the GUI automatically disables the part using the Enable when critical parameters for the MIC24045 are changed.
Parameters	Switch Freq	This spin box allows setting the available switching frequencies.
	Current Limit	This spin box allows setting the available low-side current limits in order to obtain the nominal load currents.
	Soft Start	This spin box allows setting the available soft-start times.
	Start Delay	This spin box allows setting the available start time delays.
	Read/Write	These buttons are used to write the registers that contain the information described above.
Output Voltage	Voltage	This spin box allows setting the available output voltages.
	Margining	This spin box allows setting the available margining options.
	Read/Write	These buttons are used to write the registers that contain the output voltage and the margining information.

MIC24045 Evaluation Kit User's Guide

This area of the GUI allows the user to modify the device features. For the MIC24045 device, the features which can be modified through I²C are the switching frequency, the current limit, the soft-start time, the startup-delay, the output voltage and the output voltage margining. For the limitations and permissible settings of the MIC24045, refer to the device datasheet.

Note that the **Enable** button does not control the device through I²C, but through a direct hardware connection to the MIC24045 EN pin.

4.2.5 MIC24045 I²C Diagnostic

The MIC24045 Diagnostic area contains the items in [Table 4-4](#).

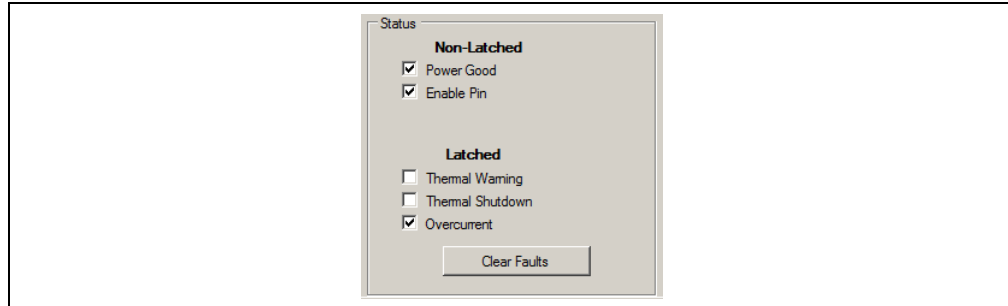

FIGURE 4-5: MIC24045 I²C Diagnostic Area.

TABLE 4-4: MIC24045 I²C DIAGNOSTIC AREA ITEMS

Panel	Items	Description
Status	Non-Latched	Power Good, Enable Pin bits logic values (ticked = '1', blank = '0')
	Latched	Thermal Warning, Thermal Shutdown, Overcurrent (ticked = '1', blank = '0')
	Clear Faults	This button allows the user to clear the faults.

The MIC24045 I²C Diagnostic area resumes the information contained in the Status register. The Status register contains latched (Flag) or non-latched (Status) bits. Flag bits are set when the corresponding fault condition occurs and do not return to zero once the fault conditions ceases. If such a fault occurs, it is the user's responsibility to clear it through the **Clear Faults** button. Status bits are set when the corresponding fault condition has occurred, and return to zero automatically once the fault condition has ceased. This information is refreshed once every two seconds.

Because of this refresh traffic, when using a logic analyzer it is more difficult to synchronize the exact moment of a certain command. In order to simplify this, an auxiliary trigger signal is used on pin GP0 of the MCP2221 Breakout Module. This signal is triggered for each user read/write command.

4.2.6 MIC24045 Output Voltage Step

The MIC24045 Output Voltage Step area contains the items in [Table 4-5](#).

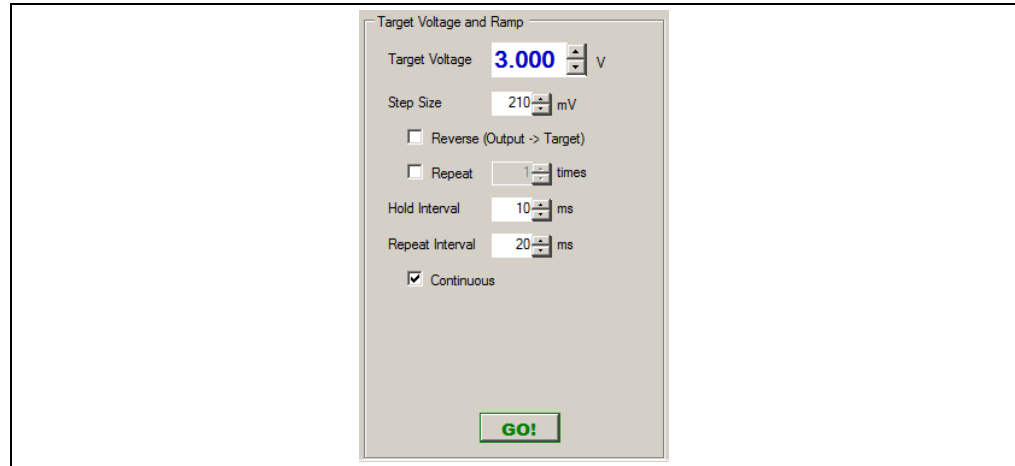

FIGURE 4-6: MIC24045 Output Voltage Ramp Area.

TABLE 4-5: MIC24045 OUTPUT VOLTAGE STEP ITEMS

Panel	Item	Description
Target Voltage and Ramp	Target Voltage	This spin box allows the user to set the voltage for output ramp up.
	Step Size	This spin box allows the user to set the value of the steps to ramp up/down the voltage.
	Hold Interval	This spin box allows the user to define the settling time between subsequent ramp ups.
	Reverse (Output → Target)	If the Reverse (Output → Target) box is checked, once the GO button is pressed, the GUI will ramp down from the Target Voltage to the Output Voltage and vice versa if it is not checked.
	Repeat	In the Repeat box, the user can select the number of ramps up/down.
	Repeat Interval	This spin box allows the user to set the repeat time between subsequent ramp up/downs, between the Output Voltage and Target Voltage.
	Continuous	If the Continuous box is checked, continuous ramp up/down will be done until stopped by the user.
	GO!	Initiates all voltage ramps.

The MIC24045 Output Voltage Ramp area allows the user to ramp up or down the output voltage in a controlled approach, by setting the voltage steps and the settling time between ramping up/down sequences.

By setting the Target Voltage, the GUI will issue commands to the MIC24045 in order to reach the respective value. In order to control the ramp up/down of the output voltage, the user can select the voltage step. To facilitate the reverse jump, the “Reverse (Output→Target)” check box has to be checked. Also, if a continuous jump between the two values is required, just check the “Continuous” box.

All voltage jumps are initiated by clicking the **GO!** button. If the Continuous box is checked and the **GO!** button is clicked, the **GO!** button will turn into a **STOP** button and its purpose is to stop the continuous ramp up/down.

[Figure 4-7](#) represents a scope shot of the output voltage waveform detailing the settings in the GUI, during a ramp up/down procedure.

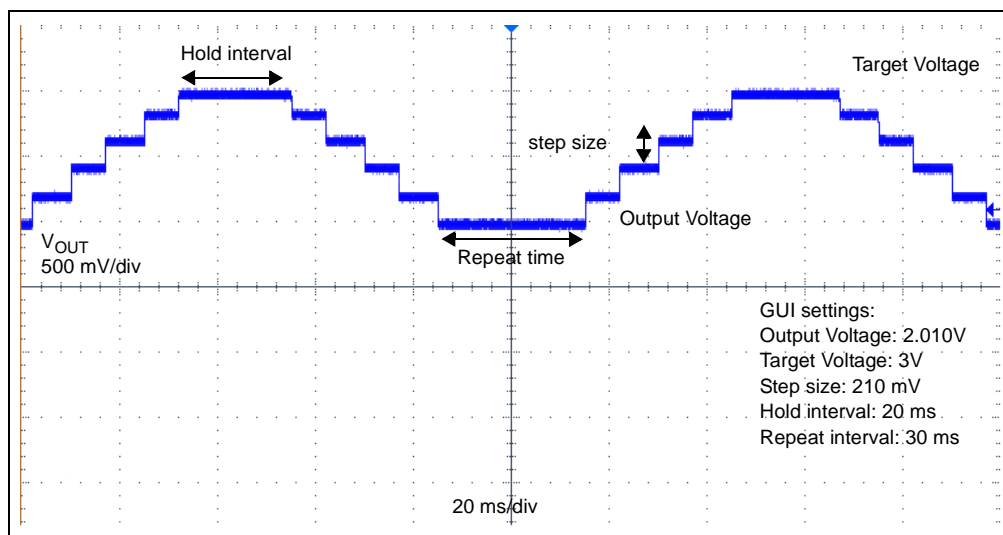

FIGURE 4-7: Output Voltage Ramp Up/Down.

4.2.7 Status Bar

The status bar provides information on the status of the device connected to the PC. The items available in the status bar are shown in [Table 4-6](#).

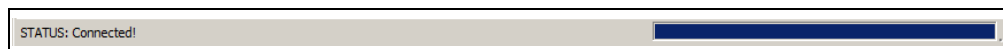

FIGURE 4-8: Status Bar.

TABLE 4-6: STATUS BAR ITEMS

Item	Description
Status Label	The status label shows if there is any device connected to the board. Refer to Table 4-7 for a list of possible labels.
Progress Bar	This bar shows the level of completion for a given command.

TABLE 4-7: STATUS LABELS

Status Label	Description
STATUS: Connected!	This message is shown when the GUI connects to a device.
STATUS: Disconnected!	This message is shown when the GUI does not detect a device connected.

Appendix A. Schematic and Layouts

A.1 INTRODUCTION

This appendix contains the following schematics and layouts for the MIC24045 Evaluation Board:

- [Board – Schematic](#)
- [Board – Top Copper and Silk](#)
- [Board – MID-LAYER 1](#)
- [Board – MID-LAYER 2](#)
- [Board – Bottom Copper](#)

A.2 BOARD – SCHEMATIC

Size-optimized layout

Functional Eval Board Section

COS on bottom layer

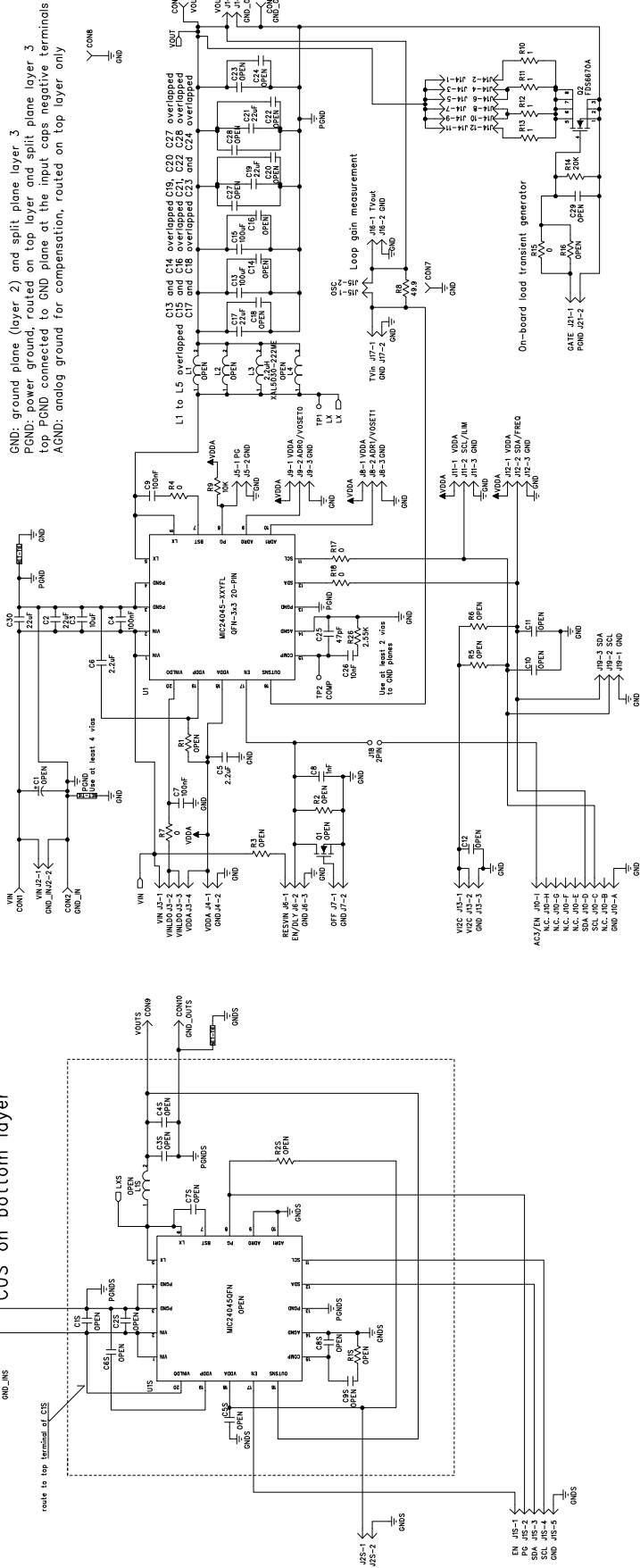

A.3 BOARD – TOP COPPER AND SILK

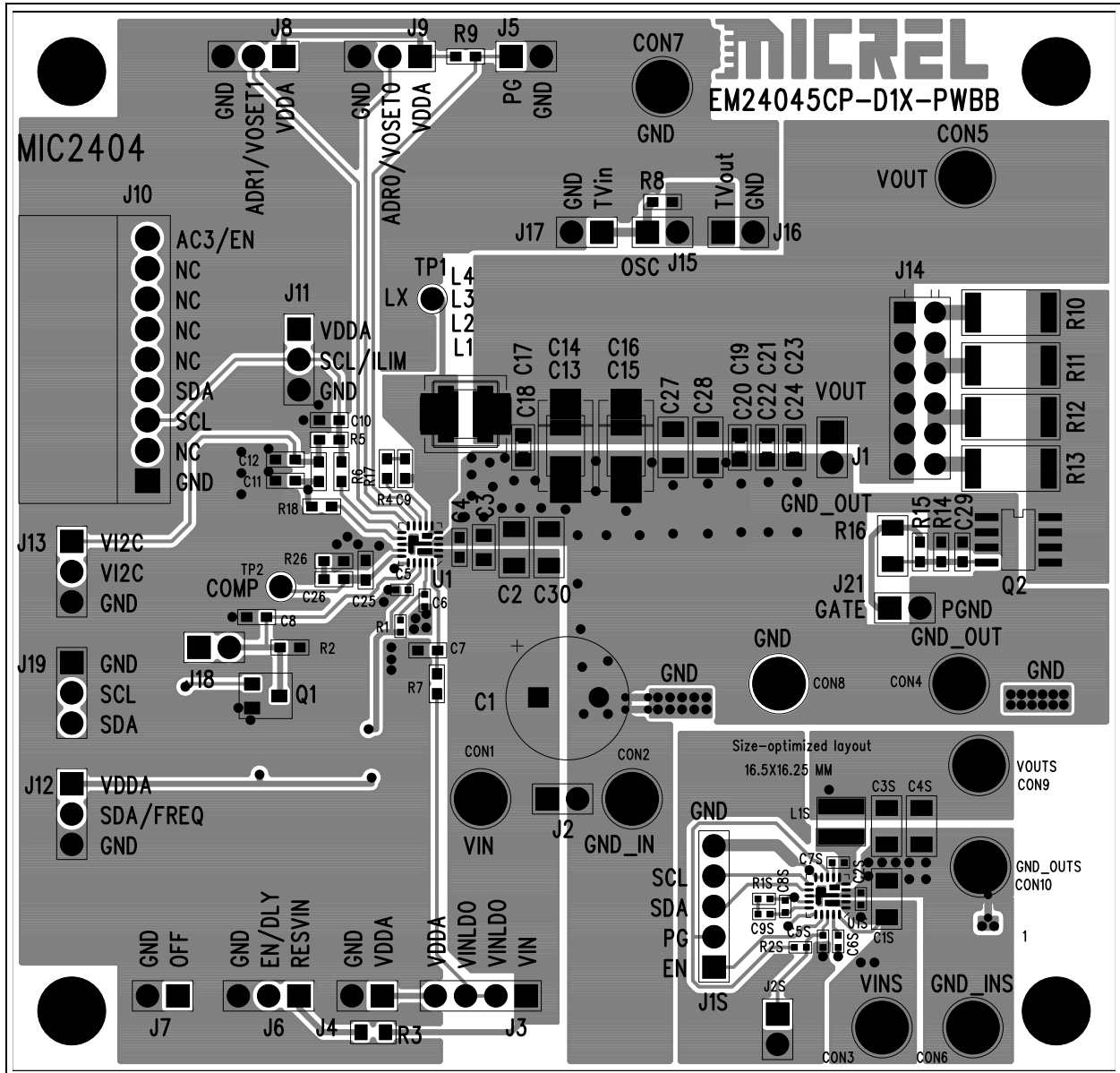

MIC24045 Evaluation Kit User's Guide

A.4 BOARD – MID-LAYER 1

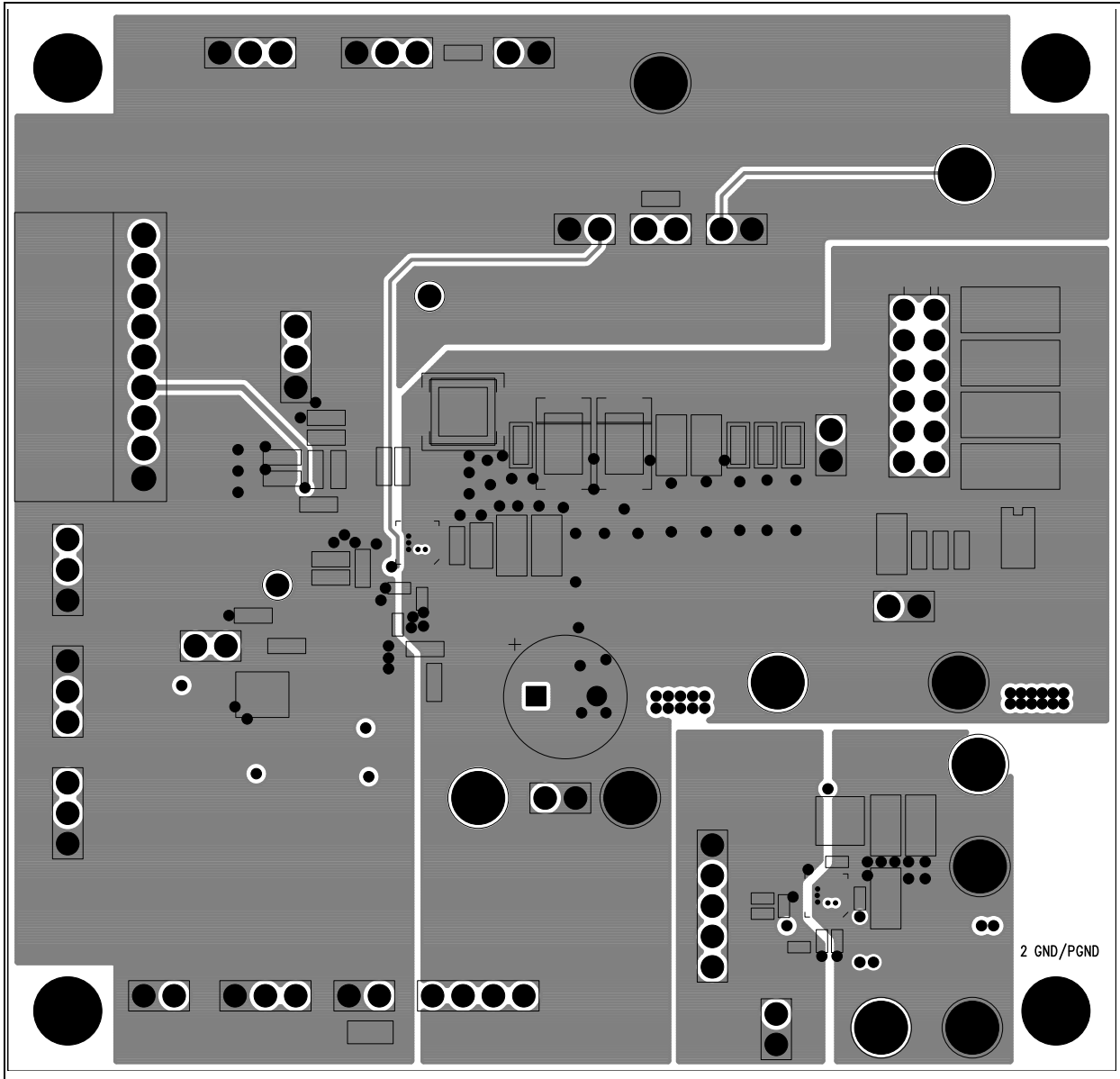

A.5 BOARD – MID-LAYER 2

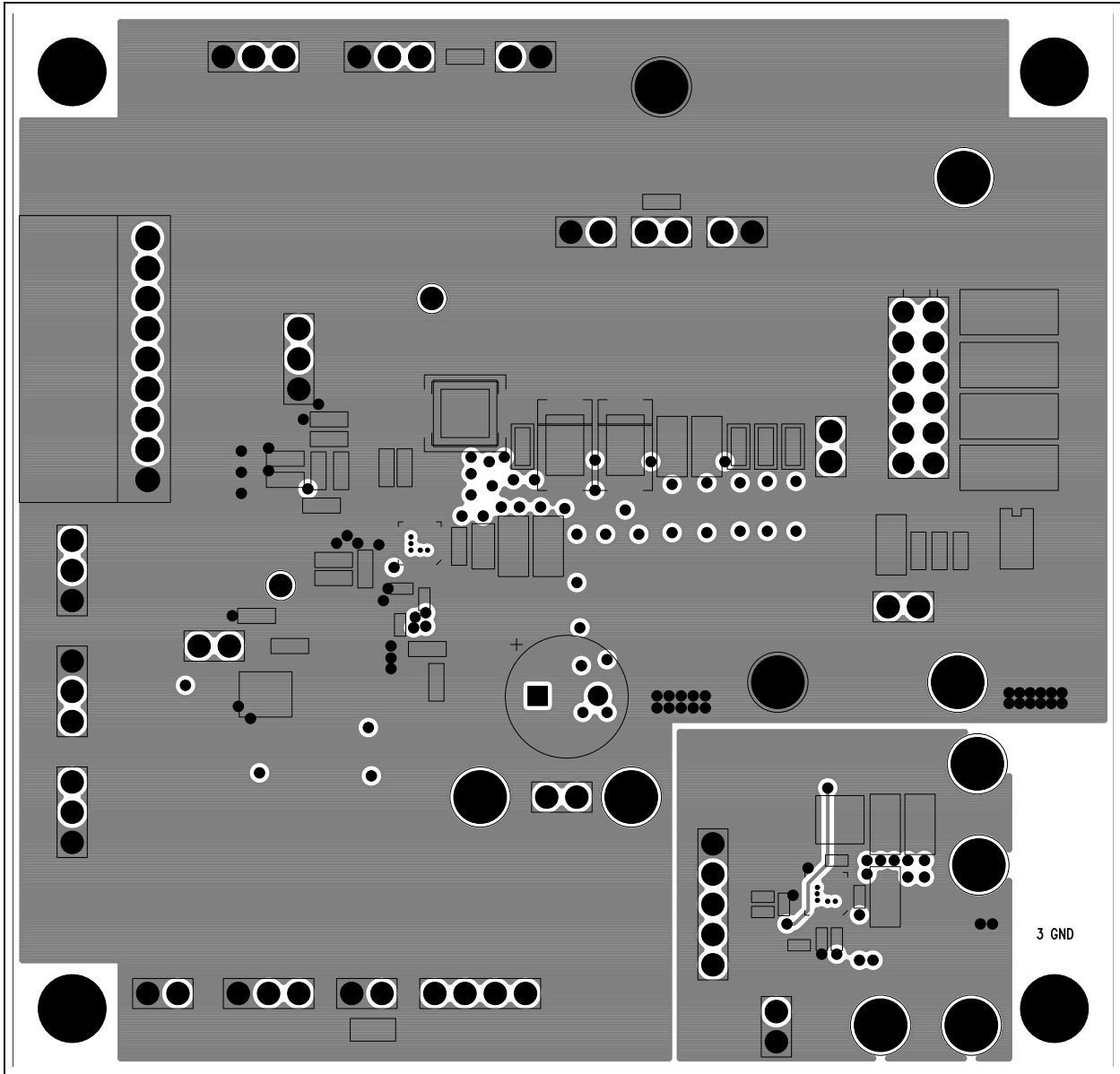

A.6 BOARD – BOTTOM COPPER

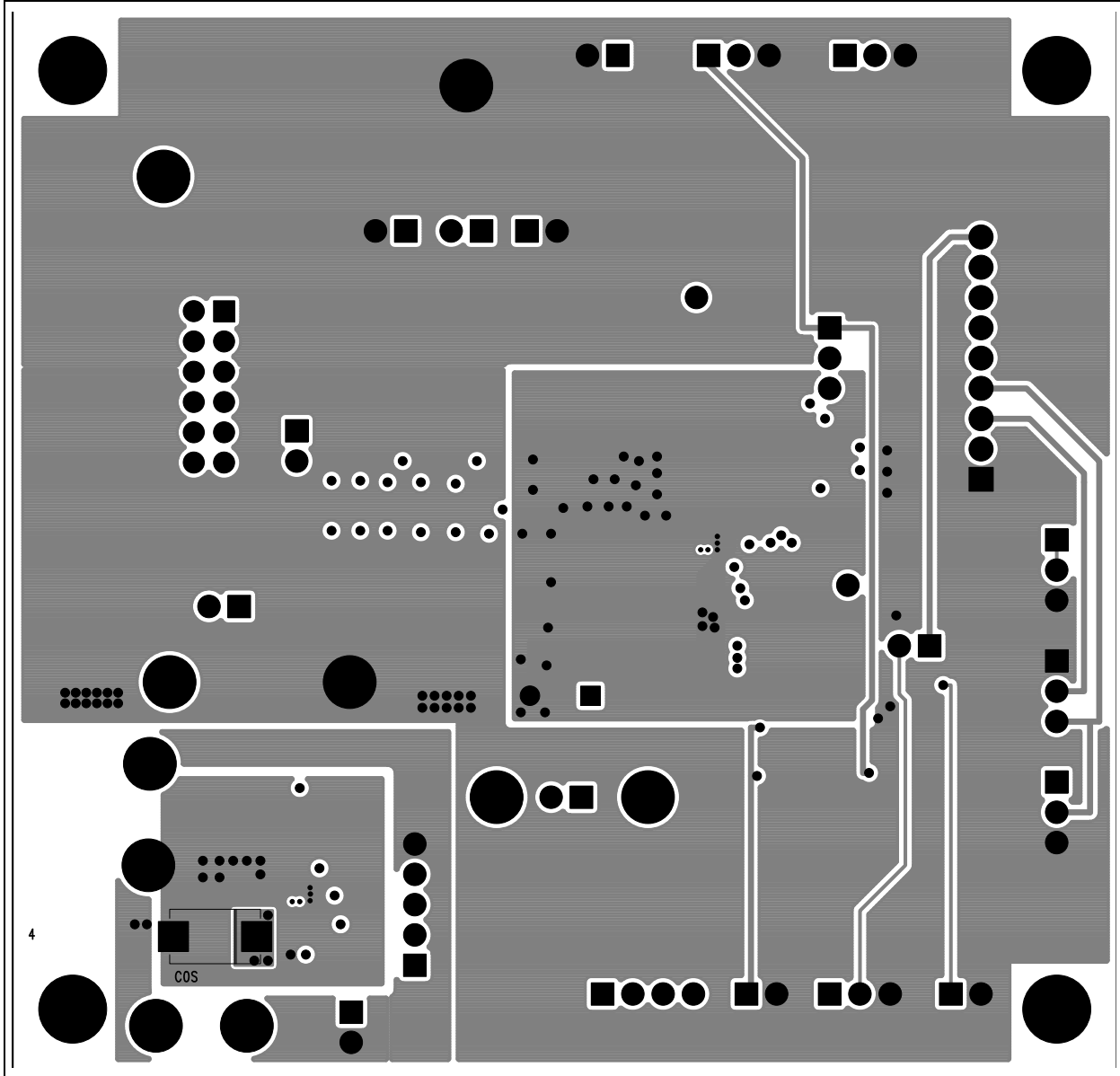

Appendix B. Bill of Materials (BOM)
TABLE B-1: BILL OF MATERIALS (BOM)

Qty.	Reference	Description	Manufacturer	Part Number
1	C1	Capacitor, THD-2 open - DO NOT POPULATE		
2	C2, C30	Capacitor, X5R, 22 μ F 25V 20%	Murata Manufacturing Co., Ltd.	GRM31CR61E226M E15
1	C3	Capacitor, X5R, 10 μ F 25V 10%	Murata Manufacturing Co., Ltd.	GRM21BR61E106- KA73
3	C4, C7, C9	Capacitor, X7R, 100 nF 50V 10%	Murata Manufacturing Co., Ltd.	GRM188R71H104- KA93
2	C5, C6	Capacitor, X5R, 2.2 μ F 16V 10%	Murata Manufacturing Co., Ltd.	GRM155R61C225K E11
1	C8	Capacitor, C0G, 1 nF 50V 5%	Murata Manufacturing Co., Ltd.	GRM1885C1H102- JA01
8	C10, C11, C12, C18, C20, C22, C24, C29	Capacitor, CHIP 0603 - DO NOT POPULATE		
2	C13, C15	Capacitor, X5R, 100 μ F 6.3V 20%	Murata Manufacturing Co., Ltd.	GRM31CR60J107M E39
2	C14, C16	Capacitor, Chip 1210 - DO NOT POPULATE		
3	C17, C19, C21	Capacitor, X5R, 22 μ F 10V 20%	Murata Manufacturing Co., Ltd.	GRM21BR61A226M E44
1	C23	Capacitor, Chip 0805 - DO NOT POPULATE		
1	C25	Capacitor, C0G, 47 pF 50V 5%	Murata Manufacturing Co., Ltd.	GRM1885C1H470- JA01
1	C26	Capacitor, C0G, 10 nF 50V 5%	Murata Manufacturing Co., Ltd.	GRM1885C1H103- JA01
5	C27, C28, C1S, C3S, C4S	Capacitor, Chip 1206 - DO NOT POPULATE		
1	C0S	Capacitor, Tant., EIA-7343 OPEN - DO NOT POPULATE		
6	C2S, C5S, C6S, C7S, C8S, C9S	Capacitor, Chip 0402 - DO NOT POPULATE		
6	CON1, CON2, CON4, CON5, CON7, CON8	Testpoint, Turret, .090	Keystone Electronics Corp.	1502-2(MM#2551-2)
4	CON3, CON6, CON9, CON10	Testpoint, Turret, .090 - DO NOT POPULATE	Keystone Electronics Corp.	1502-2(MM#2551-2)
9	J1, J2, J4, J5, J7, J15, J17, J21	Connector., Header, 2-Pin 1-Row, .100cc	Sullins Connector Solutions	PBC02SAAN

Note 1: The components listed in this Bill of Materials are representative of the PCB assembly. The released BOM used in manufacturing uses all RoHS-compliant components.

MIC24045 Evaluation Kit User's Guide

TABLE B-1: BILL OF MATERIALS (BOM) (CONTINUED)

Qty.	Reference	Description	Manufacturer	Part Number
1	J3	Connector, Header, 4-Pin 1-Row, .100cc	Sullins Connector Solutions	PBC04SAAN
7	J6 J8, J9, J11, J12, J13, J19	Connector, Header, 3-Pin 1-Row, .100cc	Sullins Connector Solutions	PBC03SAAN
1	J10	Connector, Female - RA, 09-Pin, 100cc	Sullins Connector Solutions	PPTC091LGBN-RC
1	J14	Connector, Header, 12-Pin 2-Row, .100cc	Sullins Connector Solutions	PBC06DFAN
1	J18	Jumper, 2-Pin, .100cc .062pcb	Samtec, Inc.	TSW-102-07-L-S
1	J1S	Connector, Header, 5-Pin 1-Row, .100cc	Sullins Connector Solutions	PBC05SAAN
2	JP18, JP3	Jumper, 2-Way, 2.54 mm pitch	Multicomp Inc.	SPC20479
1	L1	Inductor, SMT, IHLP-2020CZ-01-xxx - DO NOT POPULATE	Vishay/Dale	IHLP-2020CZ-01-xxx
1	L2	Inductor, SMT, IHLP-2525CZ-01-xxx - DO NOT POPULATE	Vishay/Dale	IHLP-2525CZ-01-xxx
1	L3	Inductor, SMT, 2.2 μ H, 7.2 Arms	Coilcraft	XAL5030-222ME
2	L4 L1S	Inductor, SMT, 4 mm x 4 mm - DO NOT POPULATE	Coilcraft	XAL40xx
1	PCB	Printed Circuit Board - MIC24045 Evaluation Kit	Microchip Technology Inc.	04-10558
1	Q1	MOSFET, N-Ch, SOT-23 - DO NOT POPULATE		
1	Q2	MOSFET, N-Ch, FDS6670A	Fairchild Semiconductor®	FDS6670A
3	R1, R1S, R2S	Resistor, Chip 0402 - DO NOT POPULATE		
3	R2, R5, R6	Resistor, Chip 0603 - DO NOT POPULATE		
1	R3	Resistor, Chip 0805 - DO NOT POPULATE		
5	R4, R7, R15, R17, R18	Resistor, Chip 0 Ω 1A 0603	Yageo Corporation	RC0603JR-07000RL
1	R8	Resistor, Chip 49.9 Ω 1% 0603	Yageo Corporation	RC0603FR-0749R9L
1	R9	Resistor, Chip 10 k Ω 5% 0603	Yageo Corporation	RC0603JR-0710K0L
4	R10, R11, R12, R13	Resistor, Chip 1 Ω 5% 2512	Yageo Corporation	RC2512JR-071R00L
1	R14	Resistor, Chip 20 k Ω 5% 0603	Yageo Corporation	RC0603JR-0720K0L
1	R16	Resistor, Chip 1206 - DO NOT POPULATE		
1	R26	Resistor, Chip 2.55 k Ω 1% 0603	Yageo Corporation	RC0603FR-072K55L
2	TP1-2	Testpoint, Clip, White .075" Dia.	Keystone Electronics Corp.	5002
1	U1	IC, CTQFN 3 x 3 mm 20-Pin MIC24045	Microchip Technology Inc.	MIC24045QFN
1	U1S	IC, CTQFN 3 x 3 mm 20-Pin MIC24045, DO NOT POPULATE	Microchip Technology Inc.	MIC24045QFN

Note 1: The components listed in this Bill of Materials are representative of the PCB assembly. The released BOM used in manufacturing uses all RoHS-compliant components.

Appendix C. MIC24045 Internal Registers

C.1 REGISTERS MAPS AND I²C PROGRAMMABILITY

The MIC24045 internal registers are summarized in [Table C-1](#), below.

TABLE C-1: MIC24045 REGISTER MAP

Register Address	Register Name	Type	B7	B6	B5	B4	B3	B2	B1	B0
0h	Status	RO	OCF	ThSDF	ThWrnF	Reserved	EnS	Reserved	Reserved	PGS
1h	Setting 1	RW	ILIM1	ILIM0	Freq2	Freq1	Freq0	Reserved	Reserved	Reserved
2h	Setting 2	RW	Reserved	SUDly2	SUDly1	SUDly0	Mrg1	Mrg0	SS1	SS0
3h	VOUT	RW	VOUT7	VOUT6	VOUT5	VOUT4	VOUT3	VOUT2	VOUT1	VOUT0
4h	Command	RW	Reserved	Reserved	Reserved	Reserved	Reserved	Reserved	Reserved	CIFF

C.1.1 Status Register

In the read-only Status registers, diagnostic information is provided. Bits can be F = latched (Flag) or S = non-latched (Status).

Flag bits are set when the corresponding fault condition has occurred and do not return to zero once the fault condition has ceased. Flags can only be cleared by writing '1' in Bit 0 of the Command Register 4h, or by power cycling. Status bits are set when the corresponding fault condition has occurred and return to zero automatically once the fault condition has ceased.

Default bits value at power-up is zero, except for Bit2 (which will always be read as '1') and Bit1 (QHS), which is '1' if no fault conditions are detected.

MIC24045 Evaluation Kit User's Guide

REGISTER C-1: STATUS: STATUS REGISTER (ADDRESS 0H)

R-0	R-0	R-0	R'0'	R-0	R'1'	R-1	R-0
OCF	ThSDF	ThWrnF	Reserved	EnS	Reserved	Reserved	PGS
bit 7							bit 0

Legend:

R = Readable bit W = Writable bit U = Unimplemented bit, read as '0'
 -n = Value at POR '1' = Bit is set '0' = Bit is cleared x = Bit is unknown
 RC = Read-then-clear bit

- bit 7 **OCF:** Over-Current Flag bit. OCF is set high whenever an over-current event occurs. Latched.
- bit 6 **ThSDF:** Thermal Shut-down Flag bit. ThSDF is set high whenever a Thermal Shutdown occurs. Latched.
- bit 5 **ThWrnF:** Thermal Warning Flag bit. ThWrnF is set high whenever a Thermal Warning occurs. Latched.
- bit 4 **Reserved:** Flag bit. Always read as zero.
- bit 3 **EnS:** Enable Pin Status bit. EnS reflects the logic value present on pin EN. Nonlatched.
- bit 2 **Reserved:** Status bit. Always read as '1'.
- bit 1 **Reserved:** Default status at POR is '1' (no faults detected).
- bit 0 **PGS:** Power-Good Status bit. PGS reflects the logic value present on pin PG. Nonlatched.

MIC24045 Internal Registers

REGISTER 3-1: SETTING 1 – SETTING 1 REGISTER (ADDRESS 1H)

RW-V	RW-V	RW-V	RW-V	RW-V	U-0	U-0	U-0
ILIM1	ILIM0	Freq2	Freq1	Freq0	Reserved	Reserved	Reserved
bit 7							bit 0

Legend:

R = Readable bit W = Writable bit U = Unimplemented bit, read as '0'
 -n = Value at POR '1' = Bit is set '0' = Bit is cleared x = Bit is unknown
 RC = Read-then-clear bit V = factory-programmed POR value⁽¹⁾

bit 7-6 **ILIM<1:0>**: MOSFET Current Limit bit. See the Current Limit selection in table below:

ILIM1	ILIM0	Typ. Low-Side Current Limit (A)	Typ. High-Side Current Limit (A)	Nominal Load Current (A)
0	0	3.25	4.7	2
0	1	4.3	6.2	3
1	0	5.6	8.6	4
1	1	6.2	9.4	5

bit 5-3 **Freq0 (Switching Frequency)**: See the Switching Frequency selection in table below:

Freq2	Freq1	Freq0	Frequency (kHz)
0	0	0	310
0	0	1	400
0	1	0	500
0	1	1	570
1	0	0	660
1	0	1	780
1	1	0	970
1	1	1	1200

bit 2-0 **Reserved**: Unimplemented bit. Read as '0'.

- Note 1:** Default Status settings at power-up can be changed at the factory. Standard selections are described in **Section 6.0 “MIC24045 Default Settings Values at Power-Up”** in the data sheet. Overwriting default settings by I²C has no permanent effect and values will return to factory default values upon power cycling.
- 2:** Changing Setting 1 Register values while power delivery is enabled is not recommended. To change settings by I²C, set EN pin low first, then write the new configuration, and finally set EN pin high again to resume power delivery.

MIC24045 Evaluation Kit User's Guide

REGISTER C-2: SETTING 2: SETTING 2 REGISTER (ADDRESS 2H)

U-0	RW-V	RW-V	RW-V	RW-0	RW-0	RW-V	RW-V
Reserved	SUDly2	SUDly1	SUDly0	Mrg1	Mrg0	SS1	SS0
bit 7							bit 0

Legend:

R = Readable bit W = Writable bit U = Unimplemented bit, read as '0'
 -n = Value at POR '1' = Bit is set '0' = Bit is cleared x = Bit is unknown
 RC = Read-then-clear bit V = factory-programmed POR value⁽¹⁾

bit 7 **Reserved:** Unimplemented bit. Read as '0'. Writing to this bit has no effect.

bit 6-4 **SUDly<2:0>:** Start-Up Delay bit. Delay to start power delivery from the rising edge of the EN signal. See the Start-up Delay selection in table below:

SUDly2	SUDly1	SUDly0	Start-Up Delay (ms)
0	0	0	0
0	0	1	0.5
0	1	0	1
0	1	1	2
1	0	0	4
1	0	1	6
1	1	0	8
1	1	1	10

bit 3-2 **Mrg<1:0>:** Voltage Margins bit. These bits can be changed at any time during power delivery. See the Voltage Margining selection in table below:

Mrg1	Mrg0	Change to nominal V _{OUT} Setting (%)
0	0	0%
0	1	-5%
1	0	+5%
1	1	+5%

Default at power-up is <0:0>

bit 1-0 **SS1<1:0>:** Soft-Start Ramp Rate bit. See the Soft-Start Ramp Rates selection in table below:

SS1	SS0	Soft-Start Slope (V/ms)
0	0	0.16
0	1	0.38
1	0	0.76
1	1	1.5

Note 1: With the exception of Margining Bits Mrg<1:0>, changing Setting 2 register values while power delivery is enabled is not recommended. To change settings by I²C, set EN pin low first, then write the new configuration, and finally set EN pin high again to resume power delivery

2: With the exception of Margining Bits Mrg<1:0>, changing Setting 2 register values while power delivery is enabled is not recommended. To change settings by I²C, set EN pin low first, then write the new configuration, and finally, set EN pin high again to resume power deliver.

MIC24045 Internal Registers

REGISTER C-3: VOUT: VOUT REGISTER (ADDRESS 3H)

RW-V	RW-V	RW-V	RW-V	RW-V	RW-V	RW-V	RW-V
VOUT7	VOUT6	VOUT5	VOUT4	VOUT3	VOUT2	VOUT1	VOUT0
bit 7							bit 0

Legend:

R = Readable bit W = Writable bit U = Unimplemented bit, read as '0'
 -n = Value at POR '1' = Bit is set '0' = Bit is cleared x = Bit is unknown
 RC = Read-then-clear bit V = factory-programmed POR value⁽¹⁾

bit 7-0 **VOUT<7:0>**: VOUT register bits can be changed at any time during power delivery, provided that transitions from one code to another:

- are done step-by-step, by small VOUT increments. The speed of the transition is left to the user and limited by the I²C writing interface speed.
- code transition shall take place only within the same VOUT Range. Crossing boundaries of resolution ranges may cause VOUT glitches and it is not recommended.

See VOUT selection in table below:

VOUT Range	Step Size	Codes-decimal (hex)
0.640V to 1.280V	5 mV	0 (00h) to 128 (80h)
1.290V to 1.950V	10 mV	129 (81h) to 195 (C3h)
1.980V to 3.420V	30 mV	196 (C4h) to 244 (F4h)
4.750V to 5.250V	50 mV	245 (F5h) to 255 (FFh)

Note 1: Default Status settings at power-up can be changed at the factory. Standard selections are described in **Section 6.0 "MIC24045 Default Settings Values at Power-Up"** in the data sheet. Overwriting default settings by I²C has no permanent effect and values will return to factory default values upon power cycling.

2: The functionality of the MIC24045 at any output voltage selection is subject to limitations described in **Section 7.0 "Application Information"**, in the data sheet.

REGISTER C-4: COMMAND: COMMAND REGISTER (ADDRESS 4H)

RW-0	RW-0	RW-0	RW-0	RW-0	RW-0	RW-0	RW-0
Reserved	Reserved	Reserved	Reserved	Reserved	Reserved	Reserved	CIFF
bit 7							bit 0

Legend:

R = Readable bit W = Writable bit U = Unimplemented bit, read as '0'
 -n = Value at POR '1' = Bit is set '0' = Bit is cleared x = Bit is unknown
 RC = Read-then-clear bit

bit 7-1 **Reserved<7:1>**: Writing to these bits has no effect on the device operation.

bit 0 **CIFF**: Clear Fault Flags bit. Writing '1' to bit 0 will clear all Fault Flags. The CIFF bit is self-clearing and it returns to '0' as soon as the Fault Flags have been cleared.



MICROCHIP

Worldwide Sales and Service

AMERICAS

Corporate Office

2355 West Chandler Blvd.
Chandler, AZ 85224-6199
Tel: 480-792-7200
Fax: 480-792-7277
Technical Support:
[http://www.microchip.com/
support](http://www.microchip.com/support)

Web Address:
www.microchip.com

Atlanta

Duluth, GA
Tel: 678-957-9614
Fax: 678-957-1455

Austin, TX

Tel: 512-257-3370

Boston

Westborough, MA
Tel: 774-760-0087
Fax: 774-760-0088

Chicago

Itasca, IL
Tel: 630-285-0071
Fax: 630-285-0075

Cleveland

Independence, OH
Tel: 216-447-0464
Fax: 216-447-0643

Dallas

Addison, TX
Tel: 972-818-7423
Fax: 972-818-2924

Detroit

Novi, MI
Tel: 248-848-4000

Houston, TX

Tel: 281-894-5983

Indianapolis

Noblesville, IN
Tel: 317-773-8323
Fax: 317-773-5453

Los Angeles

Mission Viejo, CA
Tel: 949-462-9523
Fax: 949-462-9608

New York, NY

Tel: 631-435-6000

San Jose, CA

Tel: 408-735-9110

Canada - Toronto

Tel: 905-695-1980
Fax: 905-695-2078

ASIA/PACIFIC

Asia Pacific Office

Suites 3707-14, 37th Floor
Tower 6, The Gateway
Harbour City, Kowloon

Hong Kong

Tel: 852-2943-5100
Fax: 852-2401-3431

Australia - Sydney

Tel: 61-2-9868-6733
Fax: 61-2-9868-6755

China - Beijing

Tel: 86-10-8569-7000
Fax: 86-10-8528-2104

China - Chengdu

Tel: 86-28-8665-5511
Fax: 86-28-8665-7889

China - Chongqing

Tel: 86-23-8980-9588
Fax: 86-23-8980-9500

China - Dongguan

Tel: 86-769-8702-9880

China - Guangzhou

Tel: 86-20-8755-8029

China - Hangzhou

Tel: 86-571-8792-8115
Fax: 86-571-8792-8116

China - Hong Kong SAR

Tel: 852-2943-5100
Fax: 852-2401-3431

China - Nanjing

Tel: 86-25-8473-2460
Fax: 86-25-8473-2470

China - Qingdao

Tel: 86-532-8502-7355
Fax: 86-532-8502-7205

China - Shanghai

Tel: 86-21-5407-5533
Fax: 86-21-5407-5066

China - Shenyang

Tel: 86-24-2334-2829
Fax: 86-24-2334-2393

China - Shenzhen

Tel: 86-755-8864-2200
Fax: 86-755-8203-1760

China - Wuhan

Tel: 86-27-5980-5300
Fax: 86-27-5980-5118

China - Xian

Tel: 86-29-8833-7252
Fax: 86-29-8833-7256

ASIA/PACIFIC

China - Xiamen

Tel: 86-592-2388138
Fax: 86-592-2388130

China - Zhuhai

Tel: 86-756-3210040
Fax: 86-756-3210049

India - Bangalore

Tel: 91-80-3090-4444
Fax: 91-80-3090-4123

India - New Delhi

Tel: 91-11-4160-8631
Fax: 91-11-4160-8632

India - Pune

Tel: 91-20-3019-1500

Japan - Osaka

Tel: 81-6-6152-7160
Fax: 81-6-6152-9310

Japan - Tokyo

Tel: 81-3-6880-3770
Fax: 81-3-6880-3771

Korea - Daegu

Tel: 82-53-744-4301
Fax: 82-53-744-4302

Korea - Seoul

Tel: 82-2-554-7200
Fax: 82-2-558-5932 or
82-2-558-5934

Malaysia - Kuala Lumpur

Tel: 60-3-6201-9857
Fax: 60-3-6201-9859

Malaysia - Penang

Tel: 60-4-227-8870
Fax: 60-4-227-4068

Philippines - Manila

Tel: 63-2-634-9065
Fax: 63-2-634-9069

Singapore

Tel: 65-6334-8870
Fax: 65-6334-8850

Taiwan - Hsin Chu

Tel: 886-3-5778-366
Fax: 886-3-5770-955

Taiwan - Kaohsiung

Tel: 886-7-213-7828

Taiwan - Taipei

Tel: 886-2-2508-8600
Fax: 886-2-2508-0102

Thailand - Bangkok

Tel: 66-2-694-1351
Fax: 66-2-694-1350

EUROPE

Austria - Wels

Tel: 43-7242-2244-39
Fax: 43-7242-2244-393

Denmark - Copenhagen

Tel: 45-4450-2828
Fax: 45-4485-2829

France - Paris

Tel: 33-1-69-53-63-20
Fax: 33-1-69-30-90-79

Germany - Dusseldorf

Tel: 49-2129-3766400

Germany - Karlsruhe

Tel: 49-721-625370

Germany - Munich

Tel: 49-89-627-144-0
Fax: 49-89-627-144-44

Italy - Milan

Tel: 39-0331-742611
Fax: 39-0331-466781

Italy - Venice

Tel: 39-049-7625286

Netherlands - Drunen

Tel: 31-416-690399
Fax: 31-416-690340

Poland - Warsaw

Tel: 48-22-3325737

Spain - Madrid

Tel: 34-91-708-08-90
Fax: 34-91-708-08-91

Sweden - Stockholm

Tel: 46-8-5090-4654

UK - Wokingham

Tel: 44-118-921-5800
Fax: 44-118-921-5820

06/23/16