

Ultra Fast NPT - IGBT®

The Ultra Fast NPT - IGBT® is a new generation of high voltage power IGBTs. Using Non-Punch-Through Technology, the Ultra Fast NPT-IGBT® offers superior ruggedness and ultrafast switching speed.

Features

- Low Saturation Voltage
- Low Tail Current
- RoHS Compliant 
- Short Circuit Withstand Rated
- High Frequency Switching to 50KHz
- Ultra Low Leakage Current

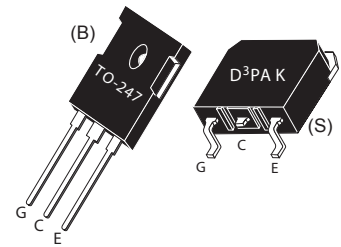

Unless stated otherwise, Microsemi discrete IGBTs contain a single IGBT die. This device is recommended for applications such as induction heating (IH), motor control, general purpose inverters and uninterruptible power supplies (UPS).

MAXIMUM RATINGS

All Ratings: $T_C = 25^\circ\text{C}$ unless otherwise specified.

Symbol	Parameter	Ratings	Unit
V_{CES}	Collector Emitter Voltage	1200	V
V_{GE}	Gate-Emitter Voltage	± 30	
I_{C1}	Continuous Collector Current @ $T_C = 25^\circ\text{C}$	88	A
I_{C2}	Continuous Collector Current @ $T_C = 100^\circ\text{C}$	40	
I_{CM}	Pulsed Collector Current ^①	160	
SCWT	Short Circuit Withstand Time: $V_{CE} = 600V, V_{GE} = 15V, T_C = 125^\circ\text{C}$	10	μs
P_D	Total Power Dissipation @ $T_C = 25^\circ\text{C}$	500	W
T_J, T_{STG}	Operating and Storage Junction Temperature Range	-55 to 150	$^\circ\text{C}$
T_L	Max. Lead Temp. for Soldering: 0.063" from Case for 10 Sec.	300	

STATIC ELECTRICAL CHARACTERISTICS

Symbol	Parameter	Min	Typ	Max	Unit
$V_{(BR)CES}$	Collector-Emitter Breakdown Voltage ($V_{GE} = 0V, I_C = 1.0mA$)	1200			Volts
$V_{GE(TH)}$	Gate Threshold Voltage ($V_{CE} = V_{GE}, I_C = 2.0mA, T_J = 25^\circ\text{C}$)	3.5	5.0	6.5	
$V_{CE(ON)}$	Collector-Emitter On Voltage ($V_{GE} = 15V, I_C = 40A, T_J = 25^\circ\text{C}$)		2.5	3.2	
	Collector-Emitter On Voltage ($V_{GE} = 15V, I_C = 40A, T_J = 125^\circ\text{C}$)		3.5		
	Collector-Emitter On Voltage ($V_{GE} = 15V, I_C = 88A, T_J = 25^\circ\text{C}$)		3.2		
I_{CES}	Collector Cut-off Current ($V_{CE} = 1200V, V_{GE} = 0V, T_J = 25^\circ\text{C}$) ^②		10	1000	μA
	Collector Cut-off Current ($V_{CE} = 1200V, V_{GE} = 0V, T_J = 125^\circ\text{C}$) ^②		100		
I_{GES}	Gate-Emitter Leakage Current ($V_{GE} = \pm 20V$)			± 250	nA



CAUTION: These Devices are Sensitive to Electrostatic Discharge. Proper Handling Procedures Should Be Followed.

DYNAMIC CHARACTERISTICS

APT40GR120B_S

Symbol	Parameter	Test Conditions	Min	Typ	Max	Unit	
C_{ies}	Input Capacitance	Capacitance $V_{GE} = 0V, V_{CE} = 25V$ $f = 1MHz$		3980		pF	
C_{oes}	Output Capacitance			320			
C_{res}	Reverse Transfer Capacitance			80			
V_{GEP}	Gate to Emitter Plateau Voltage	Gate Charge $V_{GE} = 15V$ $V_{CE} = 600V$ $I_C = 40A$		7		V	
$Q_g^{(3)}$	Total Gate Charge			210		nC	
Q_{ge}	Gate-Emitter Charge			25			
Q_{gc}	Gate- Collector Charge			90			
$t_{d(on)}$	Turn-On Delay Time	Inductive Switching (25°C) $V_{CC} = 600V$ $V_{GE} = 15V$ $I_C = 40A$ $R_G = 4.3 \Omega^{(4)}$ $T_J = +25^\circ C$		22		ns	
t_r	Current Rise Time			25			
$t_{d(off)}$	Turn-Off Delay Time			163			
t_f	Current Fall Time			40			
$E_{on2}^{(5)}$	Turn-On Switching Energy			1375	3000		μJ
$E_{off}^{(6)}$	Turn-Off Switching Energy		906	1650			
$t_{d(on)}$	Turn-On Delay Time	Inductive Switching (125°C) $V_{CC} = 600V$ $V_{GE} = 15V$ $I_C = 40A$ $R_G = 4.3 \Omega^{(4)}$ $T_J = +125^\circ C$		22		ns	
t_r	Current Rise Time			25			
$t_{d(off)}$	Turn-Off Delay Time			185			
t_f	Current Fall Time			47			
$E_{on2}^{(5)}$	Turn-On Switching Energy			1916	3500		μJ
$E_{off}^{(6)}$	Turn-Off Switching Energy			1186	2500		

THERMAL AND MECHANICAL CHARACTERISTICS

Symbol	Characteristic	Min	Typ	Max	Unit
$R_{\theta JC}$	Junction to Case Thermal Resistance			.25	°C/W
$R_{\theta JA}$	Junction to Ambient Thermal Resistance			40	
W_T	Package Weight		.22 6.2		oz g
Torque	Mounting Torque (TO-247 Package), 4-40 or M3 screw			10 6.2	in-lbf N-m

1 Repetitive Rating: Pulse width and case temperature limited by maximum junction temperature.

2 Pulse test: Pulse Width < 380μs, duty cycle < 2%.

3 See Mil-Std-750 Method 3471.

4 R_G is external gate resistance, not including internal gate resistance or gate driver impedance. (MIC4452)

5 E_{on2} is the clamped inductive turn on energy that includes a commutating diode reverse recovery current in the IGBT turn on energy loss. A combi device is used for the clamping diode.

6 E_{off} is the clamped inductive turn-off energy measured in accordance with JEDEC standard JESD24-1.

Microsemi reserves the right to change, without notice, the specifications and information contained herein.

TYPICAL PERFORMANCE CURVES

APT40GR120B_S

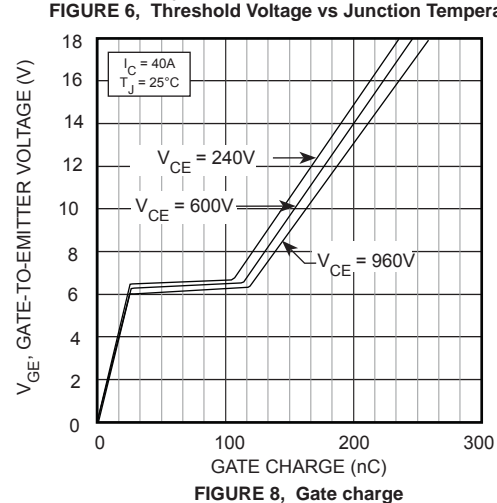
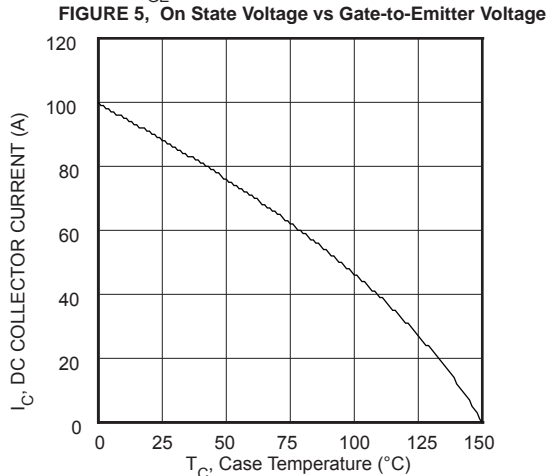
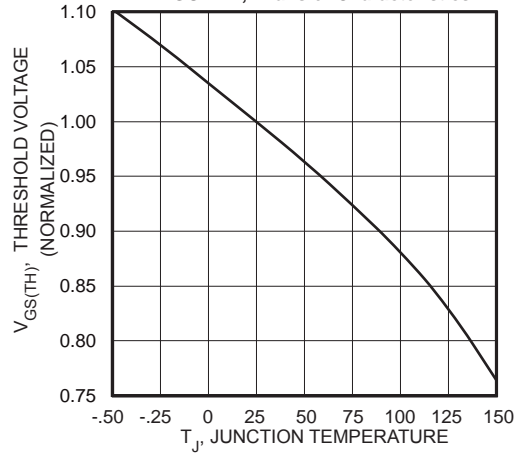
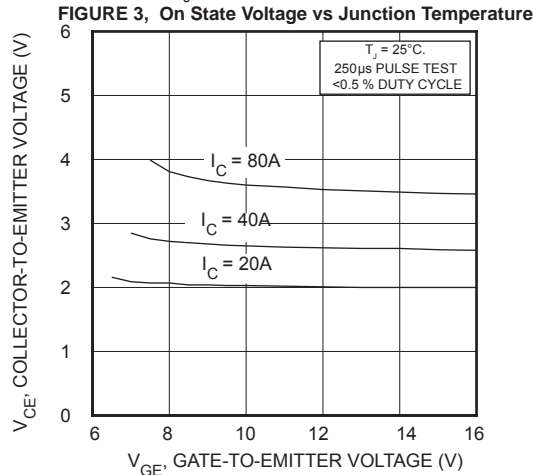
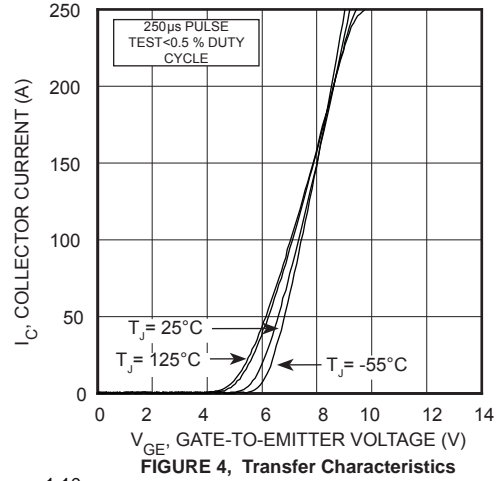
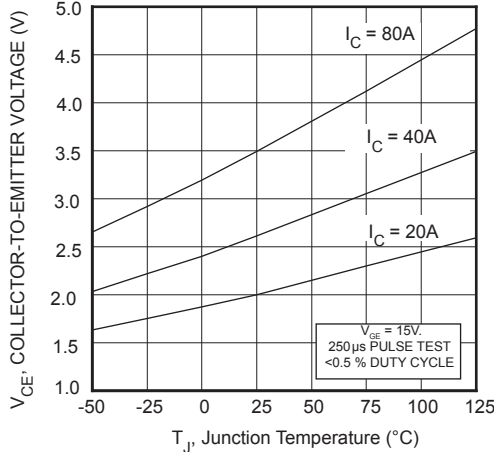
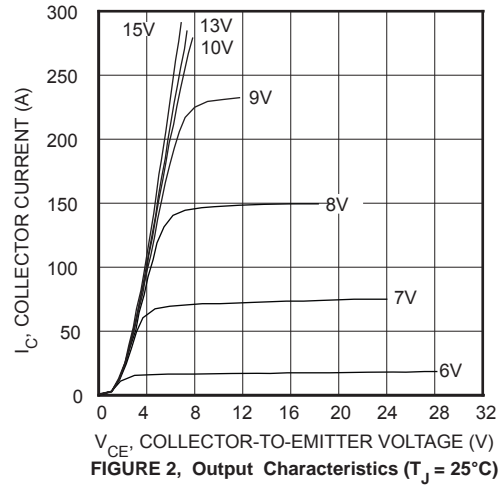
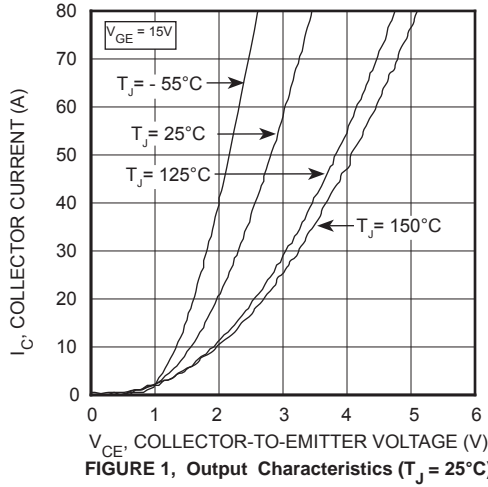

TYPICAL PERFORMANCE CURVES

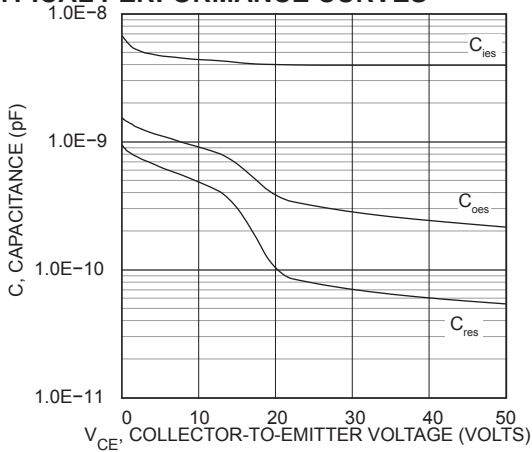

FIGURE 9, Capacitance vs Collector-To-Emitter Voltage

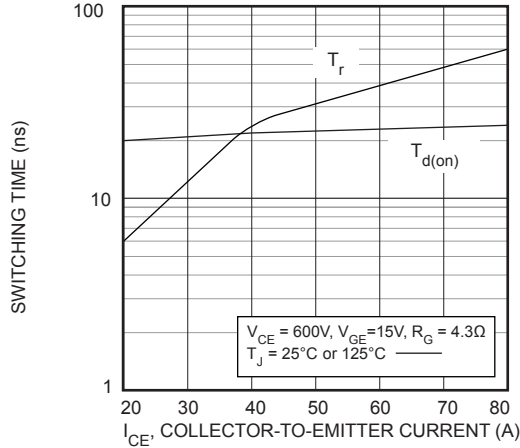

FIGURE 11, Turn-On Time vs Collector Current

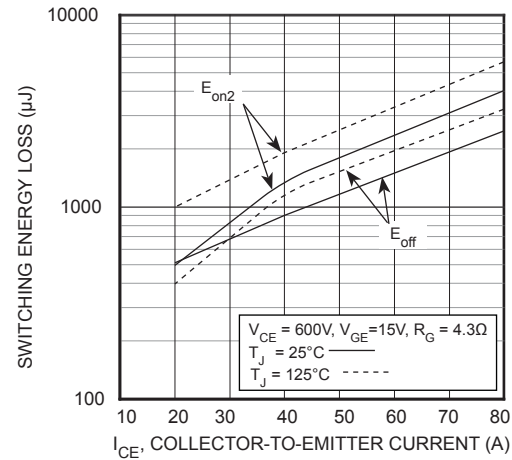

FIGURE 13, Energy Loss vs Collector Current

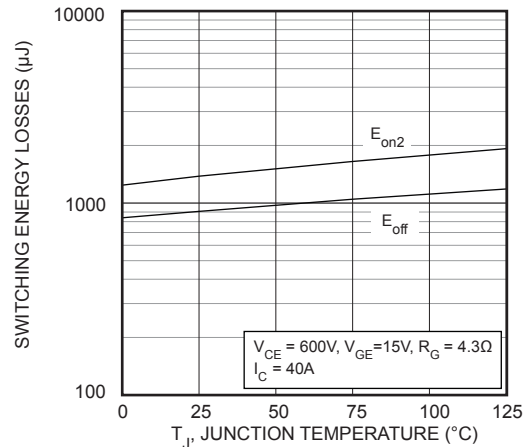

FIGURE 15, Energy Losses vs Junction Temperature

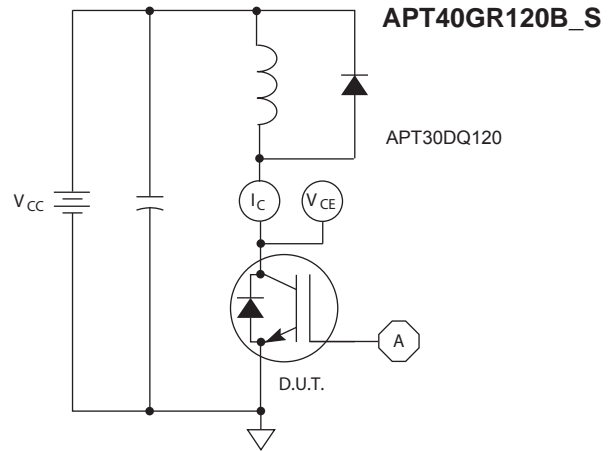

FIGURE 10, Inductive Switching Test Circuit

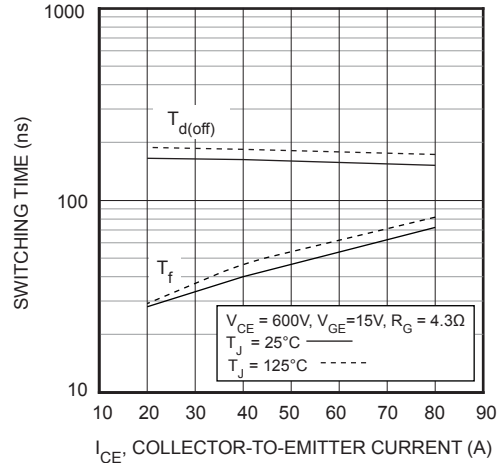

FIGURE 12, Turn-Off Time vs Collector Current

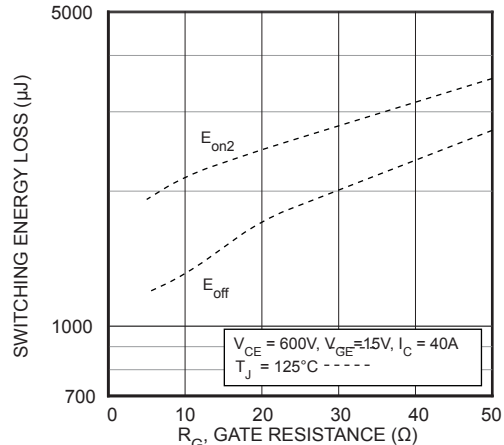

FIGURE 14, Energy Loss vs Gate Resistance

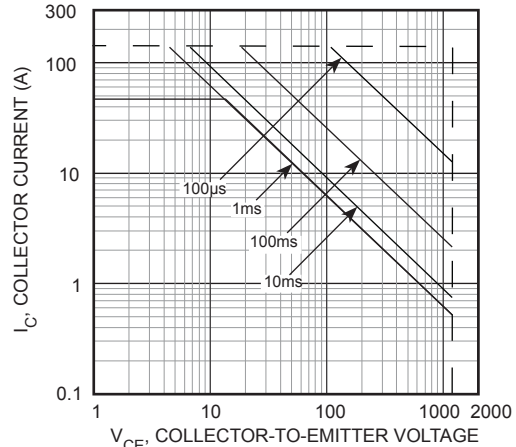

FIGURE 16, Minimum Switching Safe Operating Area

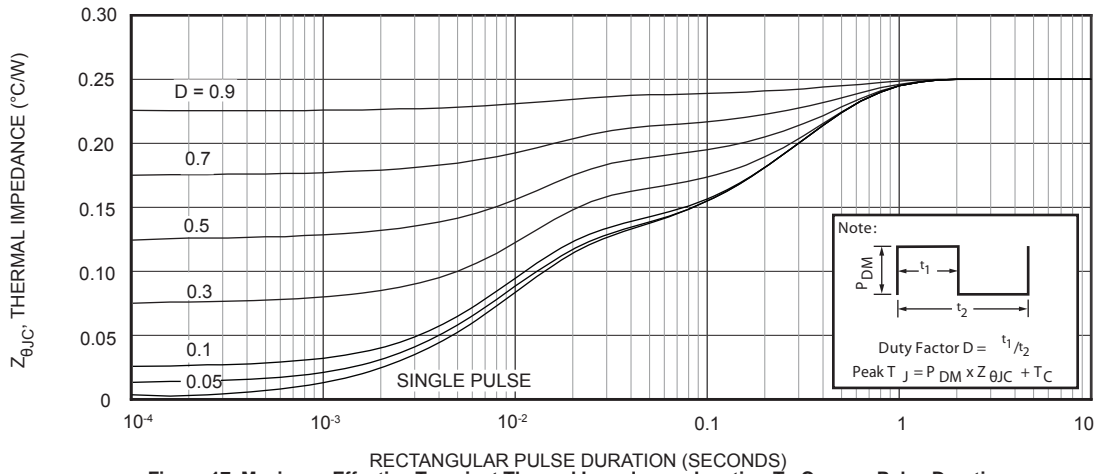
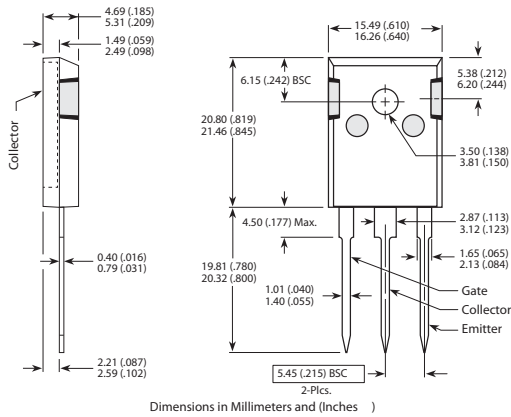

Figure 17, Maximum Effective Transient Thermal Impedance, Junction-To-Case vs Pulse Duration

TO-247 Package Outline

e3 SAC: 100% Sn Plating



D³PAK Package Outline

e3 SAC: 100% Sn Plating

