

General Description

The MIC4682 is an easy-to-use step-down (buck) switch-mode voltage regulator. It features a programmable current limit that allows 10% current limit accuracy over its full operating temperature range. The precision current limit makes the MIC4682 ideal for constant-voltage constant-current applications, such as simple battery chargers. The precision current limit also gives designers the ability to set the maximum output current below the saturation current rating of the inductor. This allows the use of the smallest possible inductors for a given application, saving valuable space and cost.

The MIC4682 is a very robust device. Its 4V to 34V input voltage range allows the MIC4682 to safely be used in applications where voltage transients may be present. Additional protection features include cycle-by-cycle current limiting and over-temperature shutdown. The MIC4682 is available in a thermally optimized power SOIC-8 package that allows it to achieve 2A of continuous output current.

The MIC4682 requires a minimum number of external components and can operate using a standard series of inductors. Compensation is provided internally for fast transient response and ease of use. The MIC4682 is available in the 8-pin power SOIC with a -40°C to $+125^{\circ}\text{C}$ junction temperature range.

Data sheets and support documentation can be found on Micrel's web site at: www.micrel.com.

Features

- Programmable output current limit
 - 10% accuracy over temperature
- Wide 4V to 34V operating input voltage range
- Fixed 200kHz PWM operation
- Power SOIC-8 package allows 2A continuous output current
- All surface mount solution
- Internally compensated
- Less than $1\mu\text{A}$ typical shutdown-mode current
- Thermal shutdown protection

Applications

- Battery chargers
- White LED drivers
- Constant voltage constant current step-down converters
- Simple step-down regulator with precise current limit
- USB power supplies

Typical Application

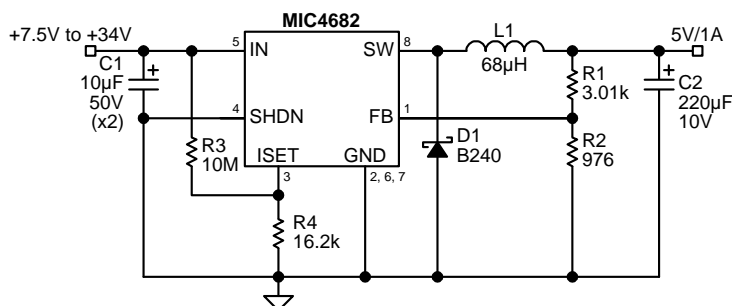

Constant Current/Constant Voltage Li-Ion Battery Charger

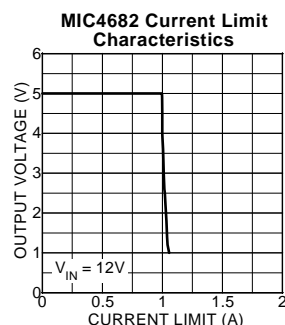

Ordering Information

Part Number		Voltage	Junction Temp. Range	Package
Standard	Pb-Free			
MIC4682BM	MIC4682YM	Adj.	-40° to +125°C	8-Pin SOIC

Note: Other Voltage available. Contact Micrel for details.

Pin Configuration

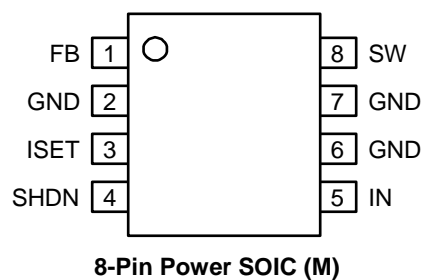

Pin Description

Pin Number	Pin Name	Pin Function
1	FB	Feedback (Input): Output voltage sense node. Connect to 1.23V-tap of the output voltage-divider network.
2, 6, 7	GND	Ground (Return): Ground.
3	ISET	Current Limit Set (Input): Connect an external resistor to ground to set the current limit. Do not ground or float this pin.
4	SHDN	Shutdown (Input): Logic low (<0.8V) enables regulator. Logic high (>2V) shuts down regulator.
5	IN	Supply Voltage (Input): Unregulated +4V to +34V supply voltage.
8	SW	Switch (Output): Internal power emitter of NPN output switch.

Absolute Maximum Ratings⁽¹⁾

Supply Voltage (V_{IN}) ⁽³⁾	38V
Shutdown Voltage (V_{SHDN}).....	-0.3V to +38V
Steady-State Output Switch Voltage (V_{SW})	-1V
Feedback Voltage (V_{FB})	12V
Current Limit Set Voltage (V_{ISET}).....	1.23V to 7V
Ambient Storage Temperature (T_s).....	-65°C to +150°C
ESD Rating ⁽⁵⁾	2kV

Operating Ratings⁽²⁾

Supply Voltage (V_{IN}) ^(4, 7)	4V to 34V
Junction Temperature Range (T_J).....	-40°C to +125°C
Thermal Resistance Impedance	
SOIC (θ_{JA}) ⁽⁶⁾	63°C/W
SOIC (θ_{JC}) ⁽⁶⁾	20°C/W

Electrical Characteristics

$V_{IN} = 12V$; $I_{OUT} = 500mA$; $R_{ISET} = 16.2k$ (1A current limit); $T_J = 25^\circ C$, **bold** values indicate $-40^\circ C \leq T_J \leq +125^\circ C$, unless noted.

Symbol	Parameter	Condition	Min	Typ	Max	Units
V_{IN}	Supply Voltage Range	Note 4	4		34	V
I_{IN}	Quiescent Current	$V_{FB} = 1.5V$		7	12	mA
	Standby Quiescent Current	$V_{SHDN} = 5V$ (Regulator off)		35	100	μA
		$V_{SHDN} = V_{IN}$			1	
V_{FB}	Feedback Voltage	($\pm 1\%$)	1.217	1.230	1.243	V
		($\pm 2\%$)	1.205		1.255	V
		$8V \leq V_{IN} \leq 34V$, $0.1A \leq I_{LOAD} \leq 0.8A$	1.193	1.230	1.267	V
			1.180		1.280	V
I_{LIM}	Current Limit Accuracy, Note 7	See Test Circuit, $V_{OUT} = 3.6V$	0.9	1	1.1	A
f_{SW}	Oscillator Frequency		180	200	220	kHz
D_{MAX}	Maximum Duty Cycle	$V_{FB} = 1.0V$	93	95		%
V_{SW}	Switch Saturation Voltage	$I_{OUT} = 1A$		1.4	1.8	V
I_{SW}	Switch Leakage Current	$V_{IN} = 34V$, $V_{SHDN} = 5V$, $V_{SW} = 0V$		2	100	μA
		$V_{IN} = 34V$, $V_{SHDN} = 5V$, $V_{SW} = -1V$		2	10	mA
V_{SHDN}	Shutdown Input Logic Level	Regulator Off	2	1.4		V
		Regulator On		1.25	0.8	V
I_{SHDN}	Shutdown Input Current	$V_{SHDN} = 5V$ (Regulator Off)	-10	-0.5	1	μA
		$V_{SHDN} = 0V$ (Regulator On)	-10	-0.5	1	μA
T_J	Thermal Shutdown			160		$^\circ C$

Notes:

- Exceeding the absolute maximum rating may damage the device.
- The device is not guaranteed to function outside its operating rating.
- Absolute maximum rating is intended for voltage transients only; prolonged DC operation is not recommended.
- $V_{IN(MIN)} = V_{OUT} + 2.5V$ or 4V whichever is greater.
- Devices are ESD sensitive. Handling precautions recommended. Human body model, 1.5k Ω in series with 100pF.
- Measured on 1.5" square of 1oz. copper FR4 printed circuit board connected to the device ground leads.
- Short circuit protection is guaranteed to $V_{IN} = 30V$ max.

Test Circuit

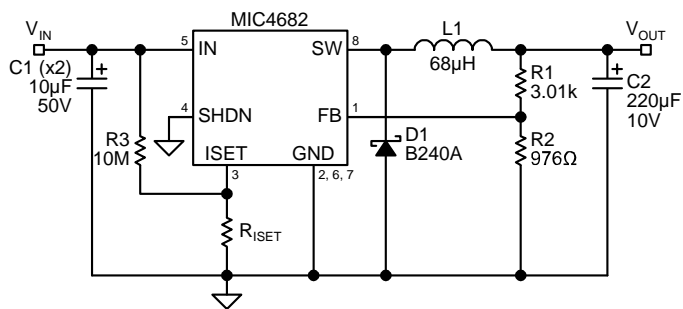

Current Limit Test Circuit

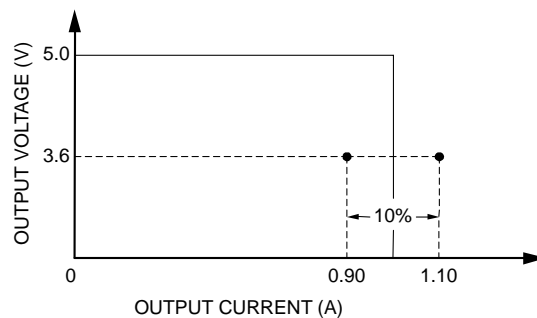

Constant-Current Constant-Voltage Accuracy

Shutdown Input Behavior

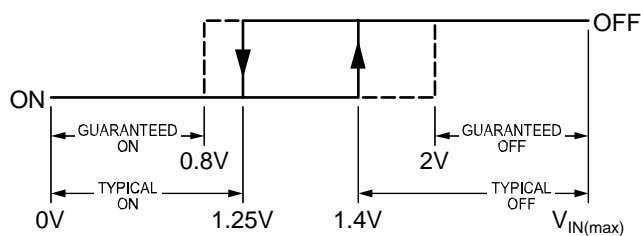

Shutdown Hysteresis

Typical Characteristics

$T_A = 25^\circ\text{C}$ unless otherwise noted.

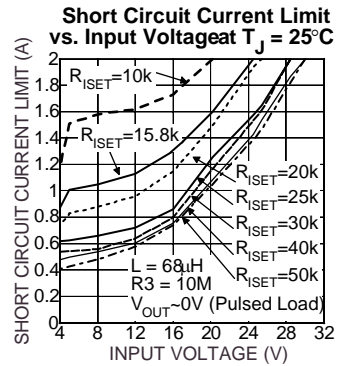
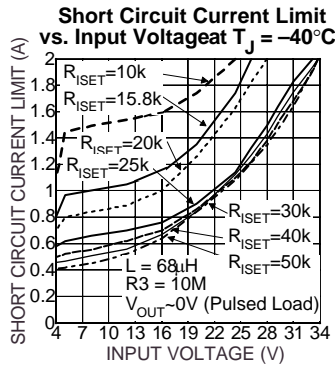
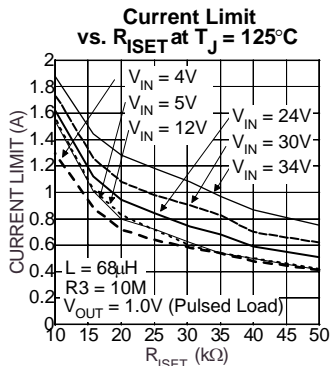
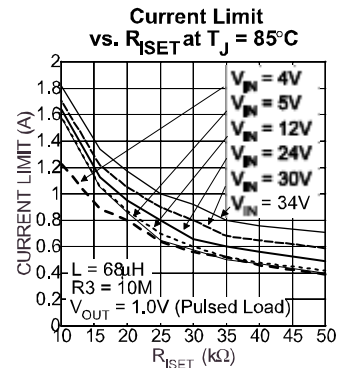
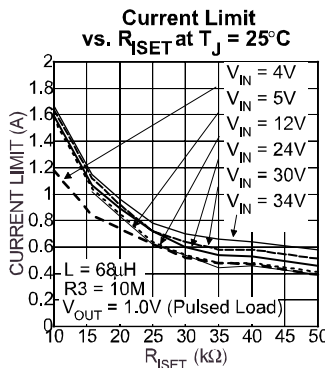
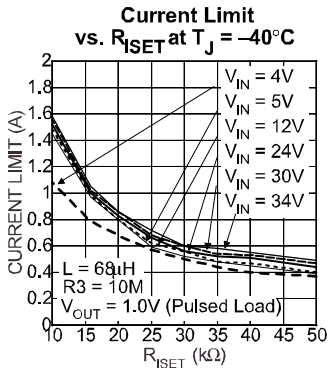
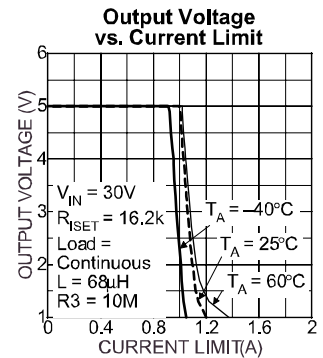
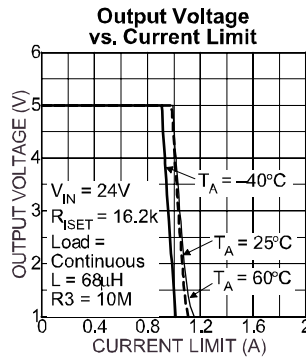
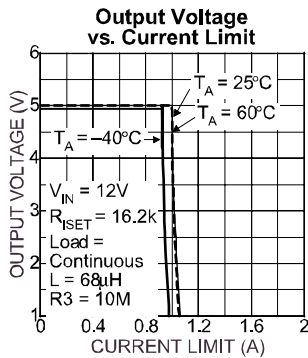
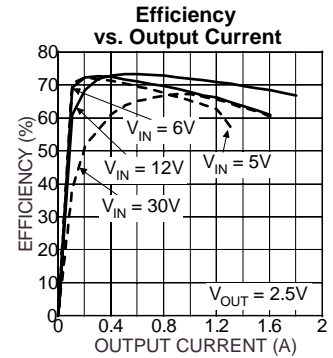
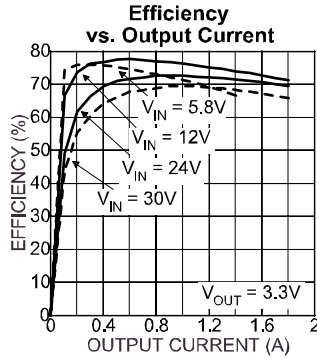
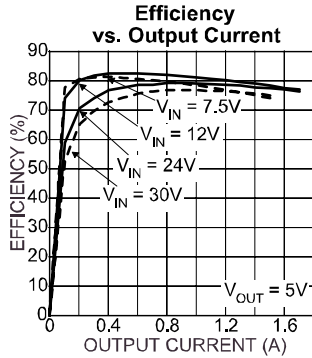

Typical Characteristics (continued)

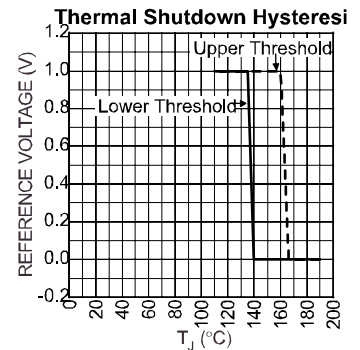
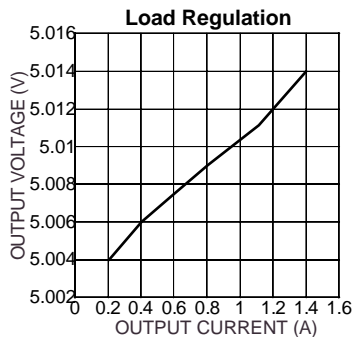
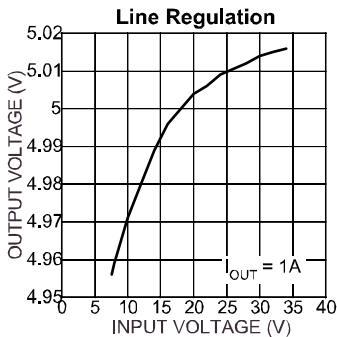
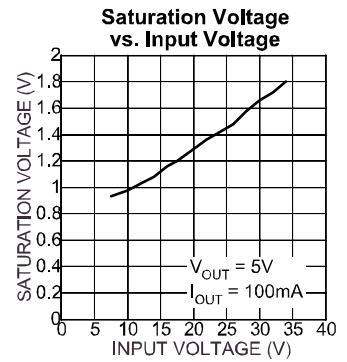
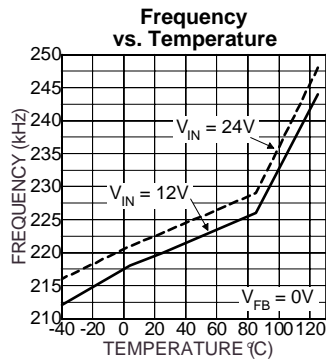
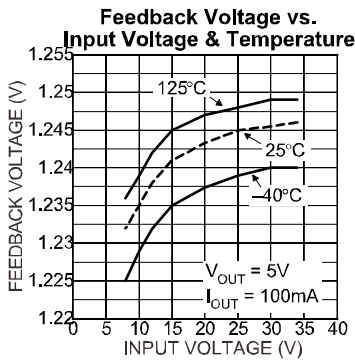
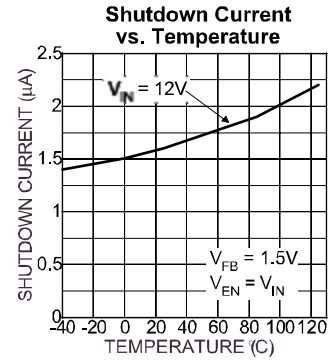
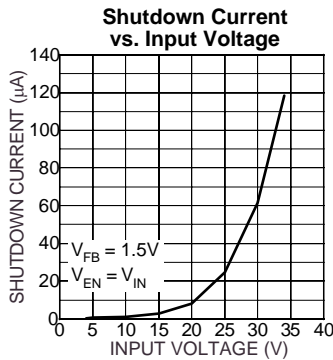
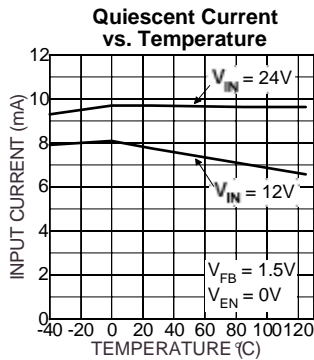
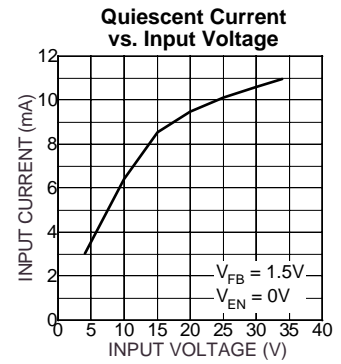
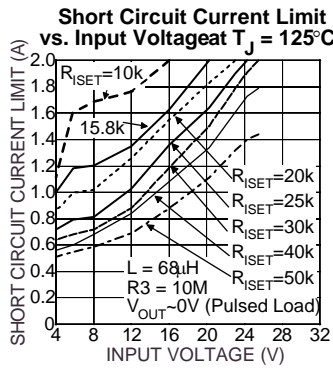
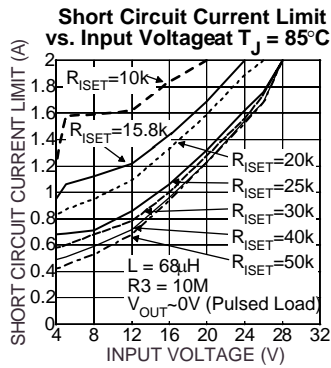

Typical Safe Operating Area (SOA)⁽¹⁾

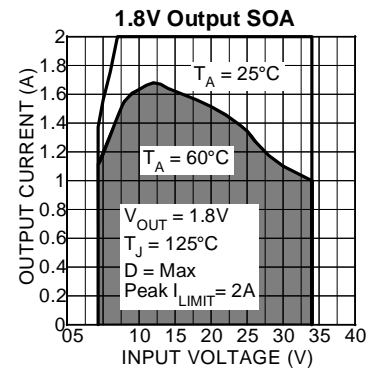
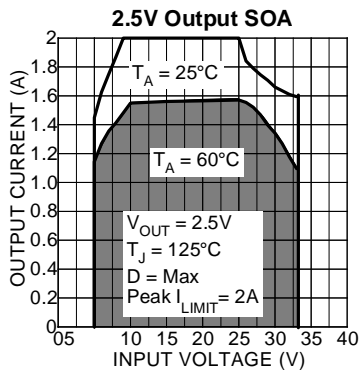
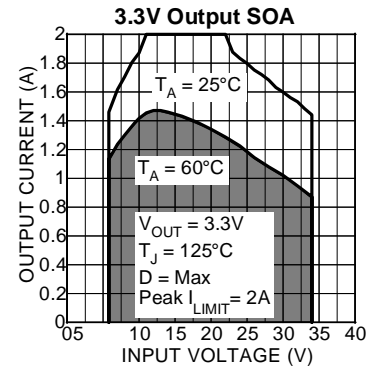
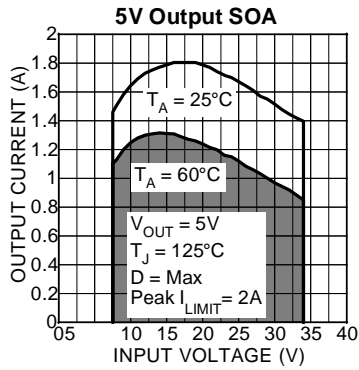

Note 1. SOA measured on the MIC4682 evaluation board.

Functional Characteristics

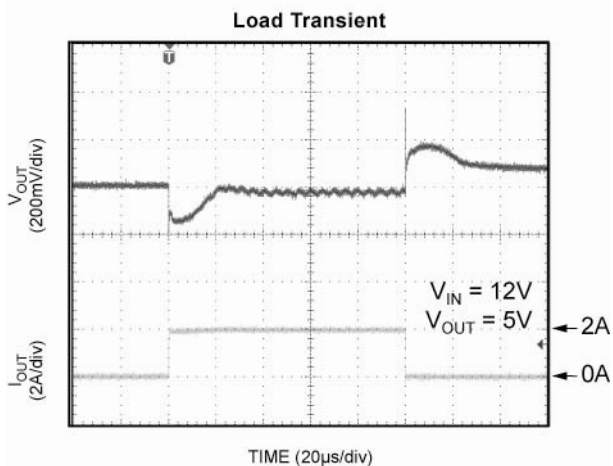

Typical Bode Plots

The following bode plots show that the MIC4682 is stable using a 68 μ H inductor (L) and a 220 μ F output capacitor (C_{OUT}). To assure stability, it is a good practice to maintain a phase margin of greater than 35°C.

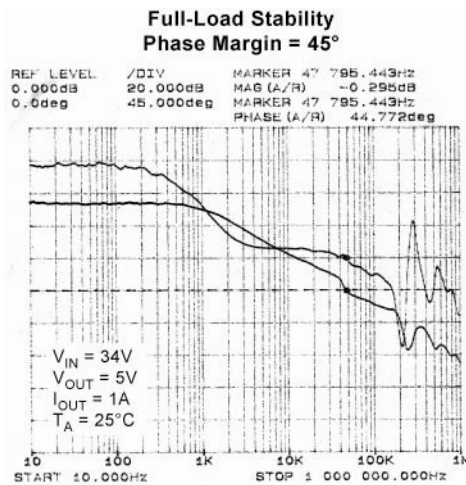
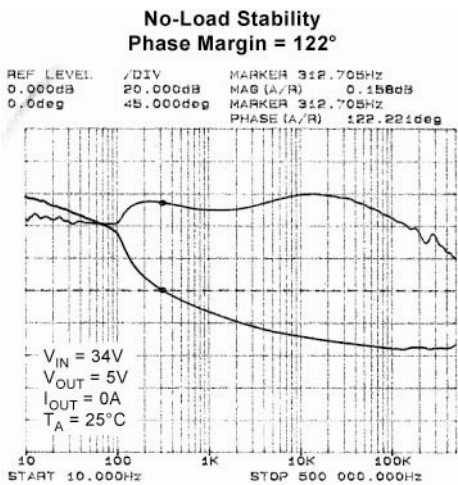
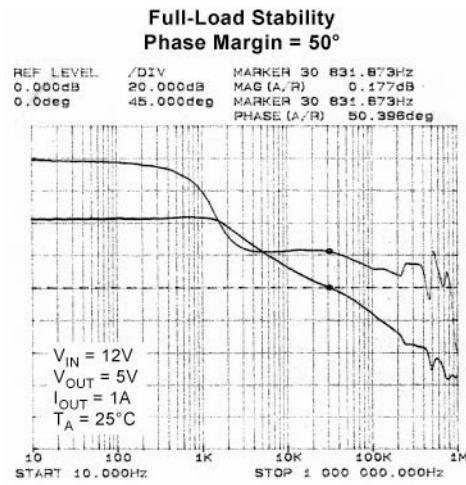
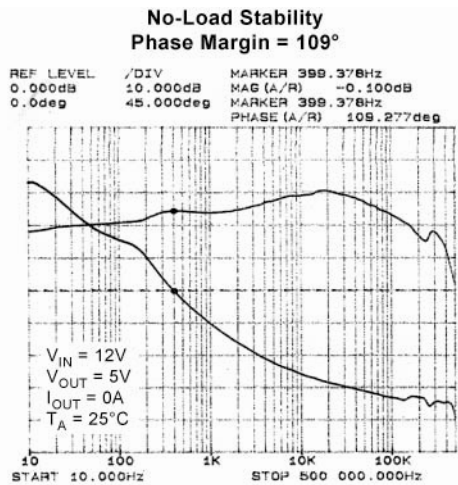
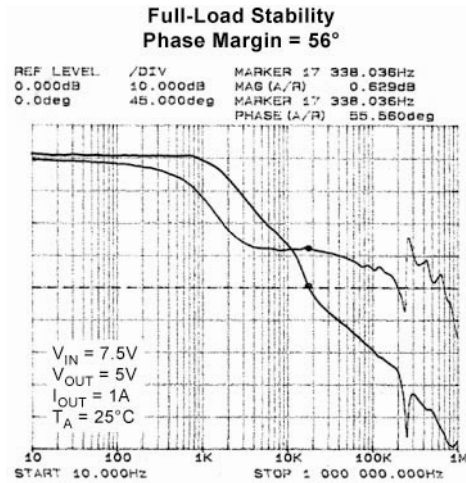
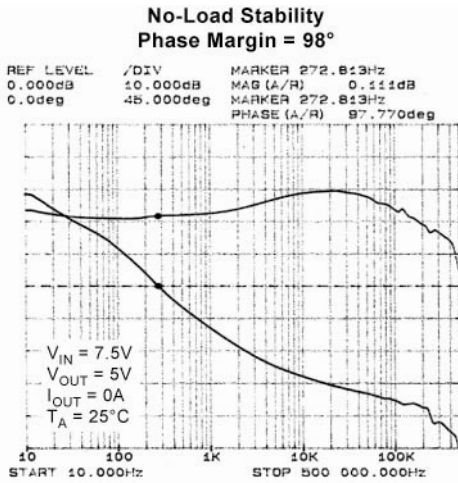

Functional Diagram

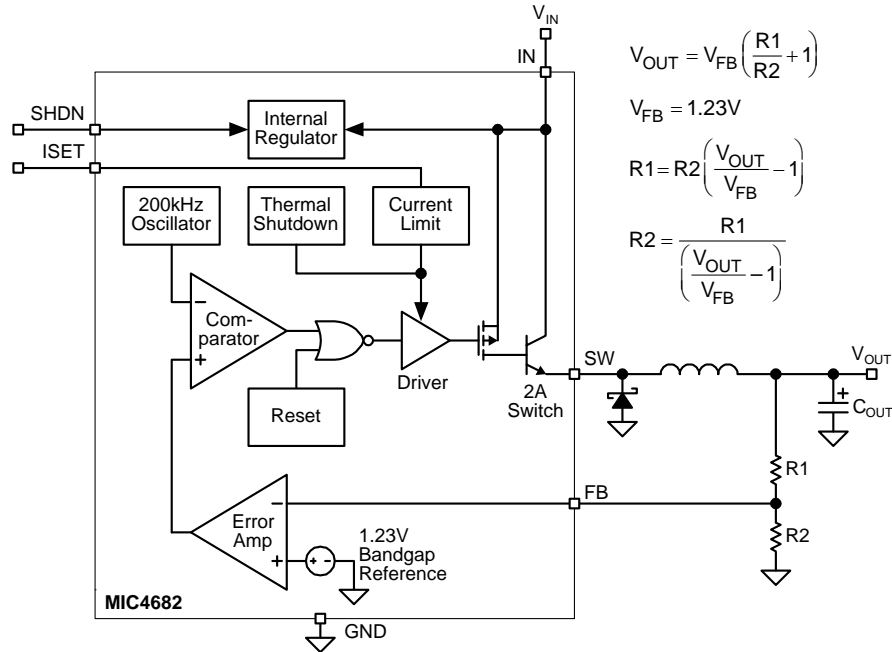

Figure 1. MIC4682 Block Diagram

Functional Description

The MIC4682 is a constant frequency, voltage mode-switching regulator. Referring to the block diagram, regulation is achieved when the feedback voltage is equal to the band gap reference. The FB pin senses the output voltage and feeds into the input of the Error Amp. The output of the Error Amp produces a positive voltage to compare with the 200kHz saw-tooth waveform. These two signals are fed into the comparator to generate the Pulse Width Modulation (PWM) signal to turn on and off the internal switch. The duty cycle is defined as the time the switch turns on divided by the period of the saw-tooth oscillator. Initially, when power is applied to the IN pin, the duty cycle is high because the feedback is close to ground. As the output and feedback voltage start to rise, the duty cycle decreases.

During the on time, current flows through the switch and into the inductor until it reaches the peak current limit or

the maximum duty cycle which turns the switch off. The external resistor at the ISET pin sets the peak current limit. The maximum duty cycle is controlled by the Reset circuitry. At this time, energy is stored in the inductor. The current charges the output capacitor and supplies to the load. The Schottky diode is reversed bias.

When the internal switch is off, the stored energy in the inductor starts to collapse. The voltage across the inductor reverses polarity and the inductor current starts to decrease. The Schottky diode clamps the switch voltage from going too negative and provides the path for the inductor current. During the off time, the inductor and the output capacitor provide current to the load.

An internal regulator provides power to the control circuitry and the thermal protection circuitry turns off the internal switch when the junction temperature exceeds about 160°C.

Application Information

Output Voltage

The output voltage of the MIC4682 is determined by using the following formulas:

$$V_{OUT} = V_{FB} \left(\frac{R1}{R2} + 1 \right)$$

$$R2 = \frac{R1}{\left(\frac{V_{OUT}}{V_{FB}} \right) - 1}$$

$$V_{FB} = 1.23V$$

For most applications, a 3.01k resistor is recommended for R1 and R2 can be calculated.

Input Capacitor

Low ESR (Equivalent Series Resistance) capacitor should be used for the input capacitor of the MIC4682 to minimize the input ripple voltage. Selection of the capacitor value will depend on the input voltage range, inductor value, and the load. Two Vishay Sprague 593D106X9050D2T (10 μ F/50V), tantalum capacitors are good values to use for the conditions listed in the SOA typical tables. A 0.1 μ F ceramic capacitor is recommended in parallel with the tantalum capacitors to filter the high frequency ripple. The ceramic capacitor should be placed close to the IN pin of the MIC4682 for optimum result. For applications that are cost sensitive, electrolytic capacitors can be used but the input ripple voltage will be higher.

Diode

A Schottky diode is recommended for the output diode. Most of the application circuits on this data sheet specify the Diode Inc. B340A or Micro Commercial SS34A surface mount Schottky diode. Both diodes have forward current of 3A and low forward voltage drop. These diodes are chosen to operate at wide input voltage range and at maximum output current. For lower output current and lower input voltage applications, a smaller Schottky diode such as B240A or equivalence can be used.

Inductor and Output Capacitor

A 68 μ H inductor and a 220 μ F tantalum output capacitor are chosen because of their stability over the input voltage range with maximum output current listed in the SOA typical tables. The Sumida CDRH127-680 and Vishay Sprague 593D106X9050D2T are recommended. See "Bode Plots" for additional information. With the same conditions, a lower value inductor and a higher output capacitor can be used. The disadvantages for this combination are that the output ripple voltage will be higher and the output capacitor's package size will be bigger. For example, a 47 μ H inductor and 330 μ F output capacitor are good combination. Another option is to use a higher value inductor and a lower output capacitor. The advantages of this combination are that the switch peak current and the output ripple voltage will be lower. The disadvantage is that the inductor's package size will be bigger. Applications that have lower output current requirement can use lower inductor value and output capacitor. See "Typical Application Circuits" for an example. A 0.1 μ F ceramic capacitor is recommended in parallel with the tantalum output capacitor to reduce the high frequency ripple.

Current Limit Set Resistor

An external resistor connects between the ISET pin and ground to control the current limit of the MIC4682 ranging from 400mA to 2A. For resistor value selections, see the "Typical Characteristics: Current Limit vs. R_{ISET}." In addition to the R_{ISET}, a resistor, ranging from 10M Ω to 15M Ω , between the ISET and IN pin is recommended for current limit accuracy over the input voltage range.

When the MIC4682 is in current limit, the regulator is in current mode. If the duty cycle is equal or greater than 50%, the regulator is in the sub-harmonic region. This lowers the average current limit. The below simplified equation determines at which input and output voltage the MIC4682 exhibits this condition.

$$\frac{(V_{OUT} + 1.4)}{V_{IN}} > 50\%$$

Do not short or float the ISET pin. Shorting the ISET pin will set a peak current limit greater than 2.1A. Floating the ISET pin will exhibit unstable conditions. To disable the current limit circuitry, the voltage at the ISET pin has to be between 2V and 7V.

Thermal Considerations

The MIC4682 SuperSwitcher™ features the power-SOIC-8. This package has a standard 8-pin small-outline package profile, but with much higher power dissipation than a standard SOIC-8. Micrel's MIC4682 SuperSwitcher™ family are the first DC-to-DC converters to take full advantage of this package.

The reason that the power SOIC-8 has higher power dissipation (lower thermal resistance) is that pins 2, 6, 7 and the die-attach paddle are a single piece of metal. The die is attached to the paddle with thermally conductive adhesive. This provides a low thermal resistance path from the junction of the die to the ground pins. This design significantly improves package power dissipation by allowing excellent heat transfer through the ground leads to the printed circuit board.

One limitation of the maximum output current on any MIC4682 design is the junction-to-ambient thermal resistance (θ_{JA}) of the design (package and ground plane).

Examining θ_{JA} in more detail:

$$\theta_{JA} = (\theta_{JC} + \theta_{CA})$$

where:

θ_{JC} = junction-to-case thermal resistance

θ_{CA} = case-to-ambient thermal resistance

θ_{JC} is a relatively constant 20°C/W for a power SOIC-8.

θ_{CA} is dependent on layout and is primarily governed by the connection of pins 2, 6 and 7 to the ground plane. The purpose of the ground plane is to function as a heat sink.

θ_{JA} is ideally 63°C/W, but will vary depending on the size of the ground plane to which the power SOIC-8 is attached.

Determining Ground-Plane Heat-Sink Area

There are two methods of determining the minimum ground plane area required by the MIC4682.

Quick Method

Make sure that MIC4682 pins 2, 6 and 7 are connected to a ground plane with a minimum area of 6cm². This ground plane should be as close to the MIC4682 as possible. The area may be distributed in any shape around the package or on any PCB layer as long as there is good thermal contact to pins 2, 6 and 7. This ground plane area is more than sufficient for most designs.

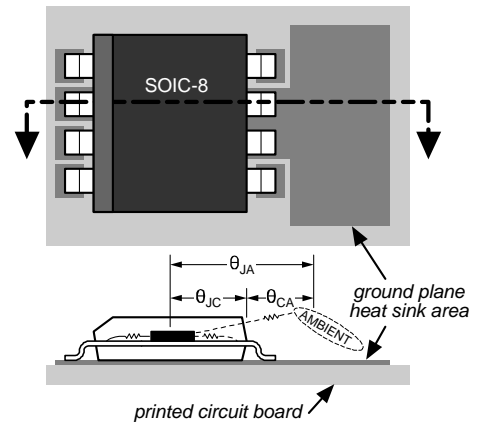

Figure 2. Power SOIC-8 Cross Section

Minimum Copper/Maximum Current Method Using Figure 3, for a given input voltage range, determine the minimum ground-plane heat-sink area required for the application's maximum continuous output current. Figure 3 assumes a constant die temperature of 75°C above ambient.

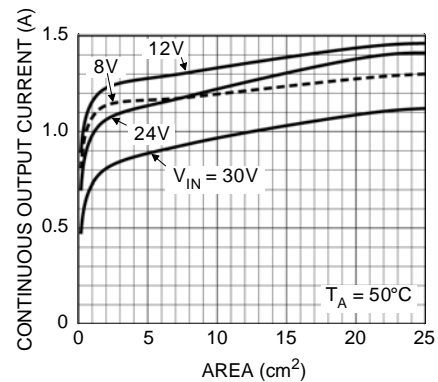

Figure 3. Output Current vs. Ground Plane Area

When designing with the MIC4682, it is a good practice to connect pins 2, 6 and 7 to the largest ground plane that is practical for the specific design.

Checking the Maximum Junction Temperature

For this example, with an output power (P_{OUT}) of 5W, (5V output at 1A maximum with $V_{IN} = 12V$) and 65°C maximum ambient temperature, what is the maximum junction temperature?

Referring to the "Typical Characteristics: Efficiency vs. Output Current" graph, read the efficiency (η) for 1A output current at $V_{IN} = 12V$ or perform your own measurement.

$$\eta = 81\%$$

The efficiency is used to determine how much of the output power (P_{OUT}) is dissipated in the regulator circuit (P_D).

$$P_D = \frac{P_{OUT}}{\eta} - P_{OUT}$$

$$P_D = \frac{5W}{0.81} - 5W$$

$$P_D = 1.17W$$

A worst-case rule of thumb is to assume that 80% of the total output power dissipation is in the MIC4682 ($P_{D(IC)}$) and 20% is in the diode-inductor-capacitor circuit.

$$P_{D(IC)} = 0.8 P_D$$

$$P_{D(IC)} = 0.8 \times 1.17W$$

$$P_{D(IC)} = 0.936W$$

Calculate the worst-case junction temperature:

$$T_J = P_{D(IC)} \theta_{JC} + (T_C - T_A) + T_{A(max)}$$

where:

T_J = MIC4682 junction temperature

$P_{D(IC)}$ = MIC4682 power dissipation

θ_{JC} = junction-to-case thermal resistance.

The θ_{JC} for the MIC4682's power-SOIC-8 is approximately 20°C/W.

T_C = "pin" temperature measurement taken at the entry point of pins 6 or 7.

T_A = ambient temperature

$T_{A(max)}$ = maximum ambient operating temperature for the specific design.

Calculating the maximum junction temperature given a maximum ambient temperature of 65°C:

$$T_J = 0.936 \times 20^\circ\text{C/W} + (45^\circ\text{C} - 25^\circ\text{C}) + 65^\circ\text{C}$$

$$T_J = 103.7^\circ\text{C}$$

This value is within the allowable maximum operating junction temperature of 125°C as listed in "Operating Ratings." Typical thermal shutdown is 160°C and is listed in "Electrical Characteristics."

Layout Considerations

Layout is very important when designing any switching regulator. Rapidly changing currents through the printed circuit board traces and stray inductance can generate voltage transients which can cause problems.

To minimize stray inductance and ground loops, keep trace lengths, indicated by the heavy lines in Figure 4, as short as possible. For example, D1 should be close to pin 7 and pin 8. C_{IN} should be close to pin 5 and pin 6. See "Applications Information: Thermal Considerations" for ground plane layout.

The feedback pin should be kept as far way from the switching elements (usually L1 and D1) as possible.

A circuit with sample layouts are provided. See Figures 5a through 5e. Gerber files are available upon request.

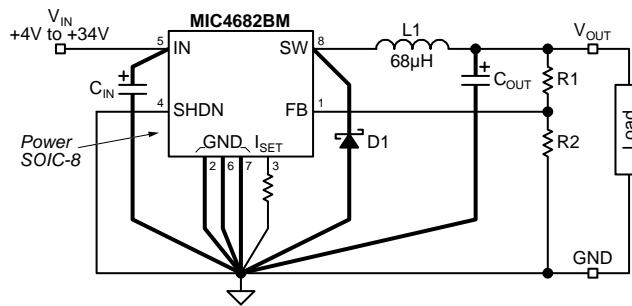

Figure 4. Critical Traces for Layout

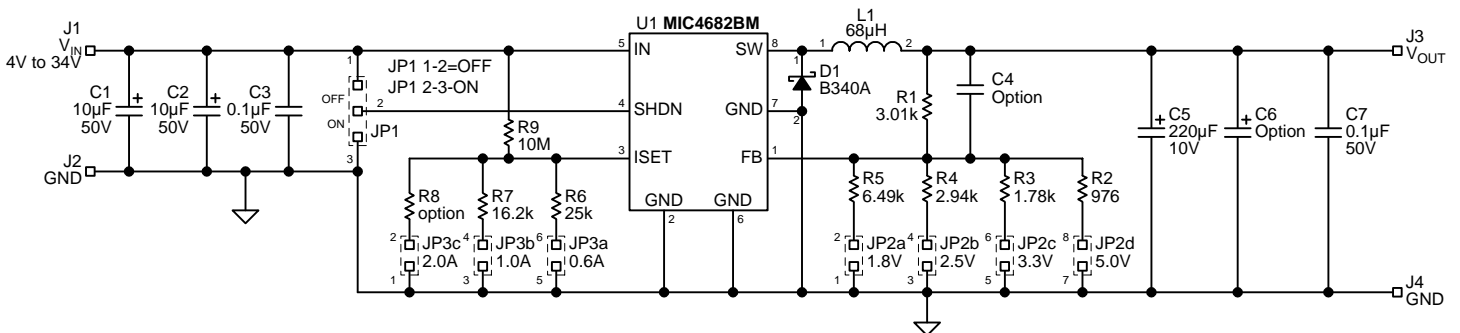

Figure 5a. Evaluation Board Schematic Diagram

Layout Example

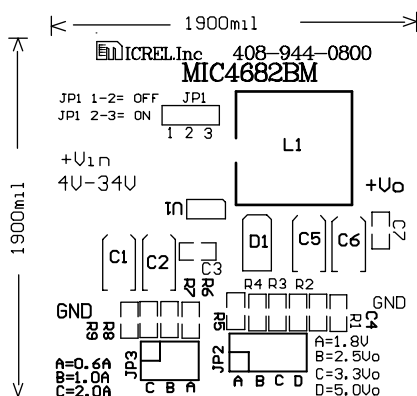

Figure 5b. Top Silkscreen

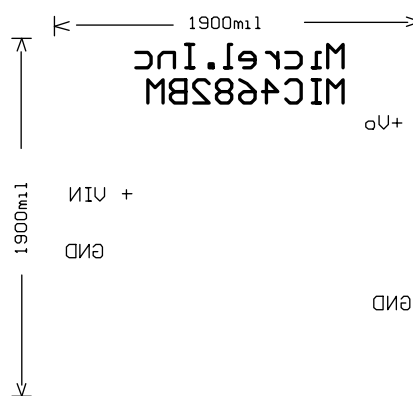

Figure 5d. Bottom Silkscreen

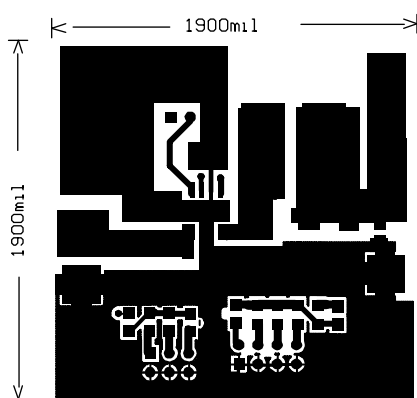

Figure 5c. Top Layer

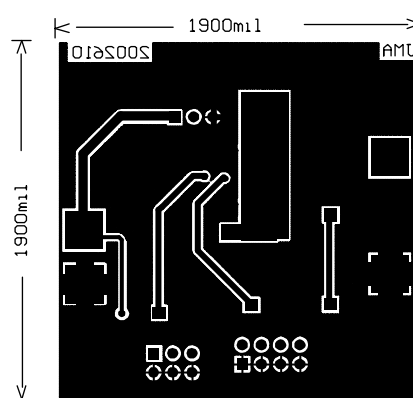

Figure 5e. Bottom Layer

Bill of Materials

Item	Part Number	Manufacturer	Description	Qty.
C1, C2	593D106X005D2T	Vishay Sprague ⁽¹⁾	10µF/50V	2
C3, C7	VJ0805Y104KXAMT	Vishay Vitramon ⁽¹⁾	0.1µF/50V	2
C5	593D227X0010D2T	Vishay Sprague ⁽¹⁾	220µF/10V	1
D1	B340A	Diodes, Inc ⁽²⁾	Schottky 3A/40V	1
L1	CDRH127-680MC	Sumida ⁽³⁾	68µH, 2.1A ISAT	1
U1	MIC4682BM	Micrel, Inc. ⁽⁴⁾	Precision Circuit Limit Buck Regulator	1

Notes:

1. Vishay: www.vishay.com
2. Diodes, Inc.: www.diodes.com
3. Sumida: www.sumida.com
4. Micrel, Inc.: www.website.com

Typical Application Circuits

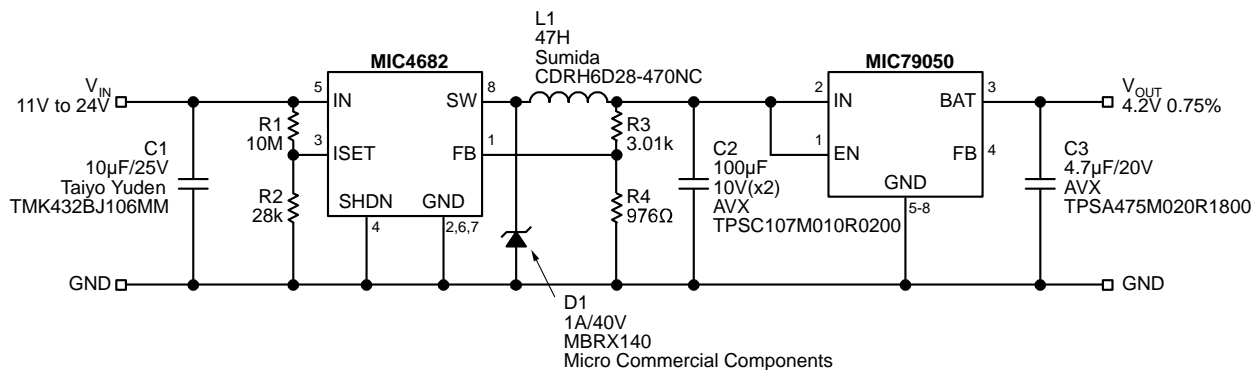

MIC4682 Current Limit Characteristics

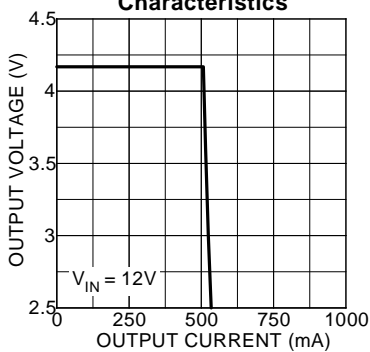

Typical Charging Characteristics

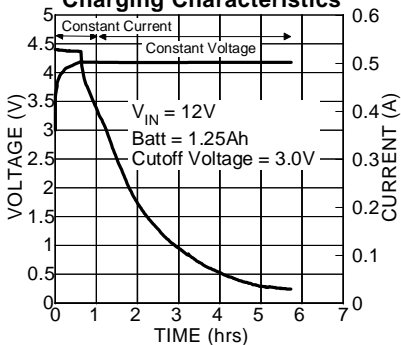
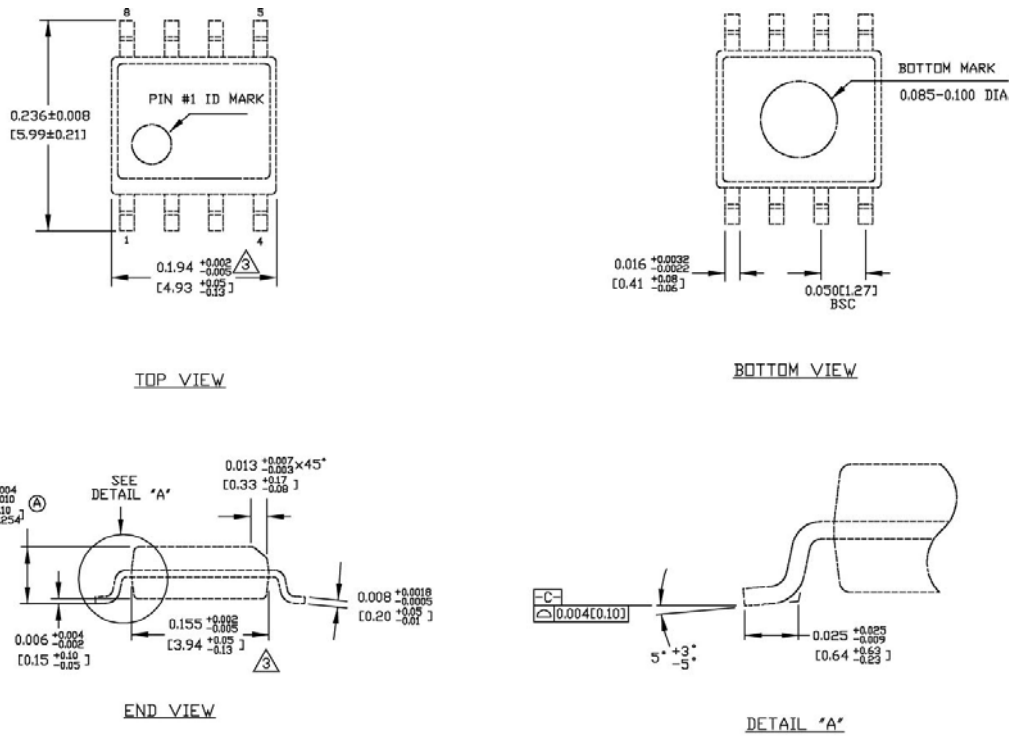

Figure 6. Low-Cost Li Ion Battery Charger with 0.75% Precision Output Voltage

Package Information



- NOTES:**
1. DIMENSIONS ARE IN INCHES[MM].
 2. CONTROLLING DIMENSION: INCHES.
 3. DIMENSION DOES NOT INCLUDE MOLD FLASH OR PROTRUSIONS, EITHER OF WHICH SHALL NOT EXCEED 0.010[0.25] PER SIDE.

8-Pin SOIC (M)

MICREL, INC. 2180 FORTUNE DRIVE SAN JOSE, CA 95131 USA
 TEL +1 (408) 944-0800 FAX +1 (408) 474-1000 WEB <http://www.micrel.com>

The information furnished by Micrel in this data sheet is believed to be accurate and reliable. However, no responsibility is assumed by Micrel for its use. Micrel reserves the right to change circuitry and specifications at any time without notification to the customer.

Micrel Products are not designed or authorized for use as components in life support appliances, devices or systems where malfunction of a product can reasonably be expected to result in personal injury. Life support devices or systems are devices or systems that (a) are intended for surgical implant into the body or (b) support or sustain life, and whose failure to perform can be reasonably expected to result in a significant injury to the user. A Purchaser's use or sale of Micrel Products for use in life support appliances, devices or systems is a Purchaser's own risk and Purchaser agrees to fully indemnify Micrel for any damages resulting from such use or sale.

© 2003 Micrel, Incorporated.