

General Description

The MIC2288 is a 1.2MHz PWM, DC/DC boost switching regulator available in low-profile Thin SOT-23 and 2mm × 2mm MLF™ package options. High power density is achieved with the MIC2288's internal 34V/1A switch, allowing it to power large loads in a tiny footprint.

The MIC2288 implements a constant frequency, 1.2MHz PWM, current mode control scheme with internal compensation that offers excellent transient response and output regulation performance. The high frequency operation saves board space by allowing small, low-profile, external components. The fixed frequency PWM topology also reduces spurious switching noise and ripple to the input power source.

The MIC2288 is available in a low-profile Thin SOT-23-5 package and a 2mm × 2mm MLF™-8 leadless package. The 2mm × 2mm MLF™-8 package option has an output overvoltage protection feature.

The MIC2288 has a junction temperature range of -40°C to +125°C.

All support documentation can be found on Micrel's web site at www.micrel.com.

Features

- 2.5V to 10V input voltage range
- Output voltage adjustable to 34V
- Over 1A switch current
- 1.2MHz PWM operation
- Stable with ceramic capacitors
- High-efficiency
- <1% line and load regulation
- Low input and output ripple
- <1μA shutdown current
- UVLO
- Output overvoltage protection (MIC2288BML)
- Over temperature shutdown
- Thin SOT-23-5 package option
- 2mm × 2mm leadless MLF™-8 package option
- -40°C to +125°C junction temperature range

Applications

- Organic EL power supply
- TFT-LCD bias supply
- 12V supply for DSL applications
- Multi-output DC/DC converters
- Positive and negative output regulators
- SEPIC converters

Typical Application

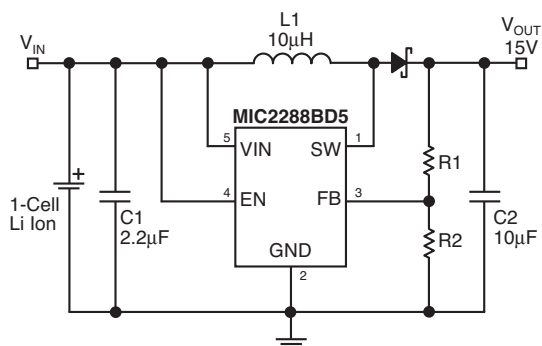

2mm × 2mm MLF™ Boost Regulator

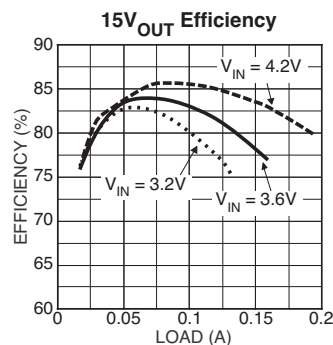

Ordering Information

Part Number	Marking Code	Output Voltage	Overvoltage Protection	Junction Temp. Range	Package	Lead Finish
MIC2288BD5	SHAA	Adjustable	–	–40°C to 125°C	Thin SOT-23-5	Standard
MIC2288YD5	SHAA	Adjustable	–	–40°C to 125°C	Thin SOT-23-5	Lead Free
MIC2288BML	SJA	Adjustable	34V	–40°C to 125°C	2x2 MLF™-8	Standard
MIC2288YML	SJA	Adjustable	34V	–40°C to 125°C	2x2 MLF™-8	Lead Free

Pin Configuration

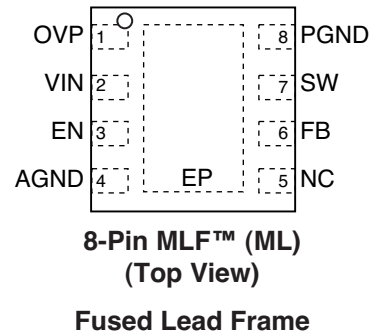
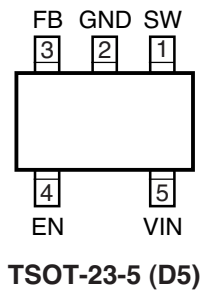

Pin Description

Pin Number TSOT-23-5	Pin Number 2x2 MLF™-8	Pin Name	Pin Function
1	7	SW	Switch Node (Input): Internal power Bipolar collector.
2		GND	Ground (Return): Ground.
3	6	FB	Feedback (Input): 1.24V output voltage sense node. $V_{OUT} = 1.24V \left(1 + \frac{R1}{R2}\right)$
4	3	EN	Enable (Input): Logic high enables regulator. Logic low shuts down regulator.
5	2	VIN	Supply (Input): 2.5V to 10V input voltage.
	1	OVP	Output Overvoltage Protection (Input): Tie this pin to V_{OUT} to clamp the output voltage to 34V maximum in fault conditions. Tie this pin to ground if OVP function is not required.
	5	NC	No Connect: No internal connection to die.
	4	AGND	Analog ground.
	8	PGND	Power ground.
	EP	GND	Exposed backside pad.

Absolute Maximum Ratings⁽¹⁾

Supply Voltage (V_{IN})	12V
Switch Voltage (V_{SW})	-0.3V to 34V
Enable Pin Voltage (V_{EN})	-0.3 to V_{IN}
FB Voltage (V_{FB})	6V
Switch Current (I_{SW})	2A
Storage Temperature (T_S)	-65°C to +150°C
ESD Rating ⁽³⁾	2kV

Operating Ratings⁽²⁾

Supply Voltage (V_{IN})	2.5V to 10V
Junction Temperature Range (T_J)	-40°C to +125°C
Package Thermal Impedance	
2mm × 2mm MLF™-8 (θ_{JA})	93°C/W
Thin SOT-23-5 (θ_{JA})	256°C/W

Electrical Characteristics⁽⁴⁾

$T_A = 25^\circ\text{C}$, $V_{IN} = V_{EN} = 3.6\text{V}$, $V_{OUT} = 10\text{V}$, $I_{OUT} = 20\text{mA}$, unless otherwise noted. **Bold** values indicate $-40^\circ\text{C} \leq T_J \leq +125^\circ\text{C}$.

Symbol	Parameter	Condition	Min	Typ	Max	Units
V_{IN}	Supply Voltage Range		2.5		10	V
V_{UVLO}	Under Voltage Lockout		1.8	2.1	2.4	V
I_{VIN}	Quiescent Current	$V_{FB} = 2\text{V}$, (not switching)		2.8	5	mA
I_{SD}	Shutdown Current	$V_{EN} = 0\text{V}^{(5)}$		0.1	1	μA
V_{FB}	Feedback Voltage	($\pm 1\%$) ($\pm 2\%$) (Over Temp)	1.227 1.215	1.24	1.252 1.265	V V
I_{FB}	Feedback Input Current	$V_{FB} = 1.24\text{V}$		-450		nA
	Line Regulation	$3\text{V} \leq V_{IN} \leq 5\text{V}$		0.1	1	%
	Load Regulation	$5\text{mA} \leq I_{OUT} \leq 40\text{mA}$		0.2		%
D_{MAX}	Maximum Duty Cycle		85	90		%
I_{SW}	Switch Current Limit			1.2		A
V_{SW}	Switch Saturation Voltage	$I_{SW} = 1\text{A}$		550		mV
I_{SW}	Switch Leakage Current	$V_{EN} = 0\text{V}$, $V_{SW} = 10\text{V}$		0.01	5	μA
V_{EN}	Enable Threshold	Turn on Turn off	1.5		0.4	V V
I_{EN}	Enable Pin Current	$V_{EN} = 10\text{V}$		20	40	μA
f_{SW}	Oscillator Frequency		1.05	1.2	1.35	MHz
V_{OVP}	Output Overvoltage Protection	MIC2288 MLF™ package option only	30	32	34	V
T_J	Overttemperature Threshold Shutdown	Hysteresis		150 10		°C °C

Notes:

1. Absolute maximum ratings indicate limits beyond which damage to the component may occur. Electrical specifications do not apply when operating the device outside of its operating ratings. The maximum allowable power dissipation is a function of the maximum junction temperature, $T_J(\text{max})$, the junction-to-ambient thermal resistance, θ_{JA} , and the ambient temperature, T_A . The maximum allowable power dissipation will result in excessive die temperature, and the regulator will go into thermal shutdown.
2. This device is not guaranteed to operate beyond its specified operating rating.
3. IC devices are inherently ESD sensitive. Handling precautions required. Human body model rating: 1.5K in series with 100pF.
4. Specification for packaged product only.
5. $I_{SD} = I_{VIN}$.

Typical Characteristics

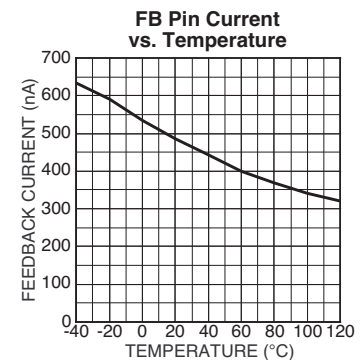
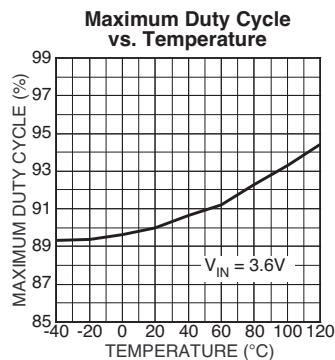
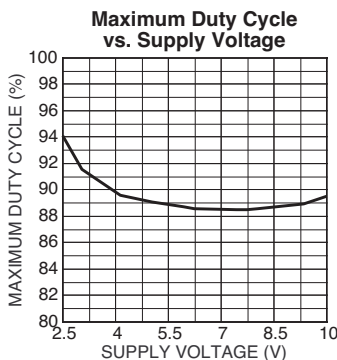
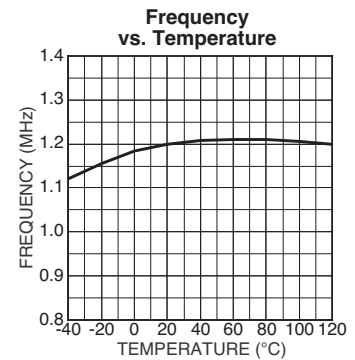
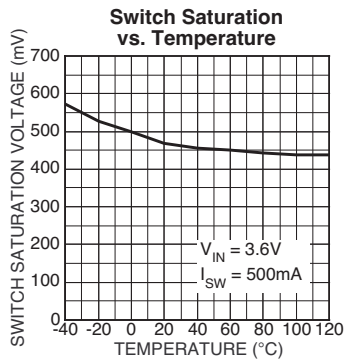
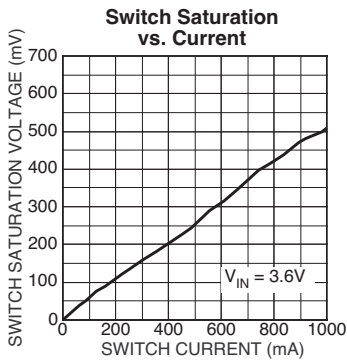
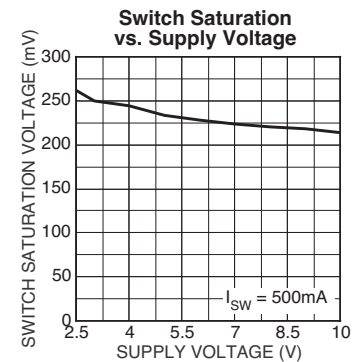
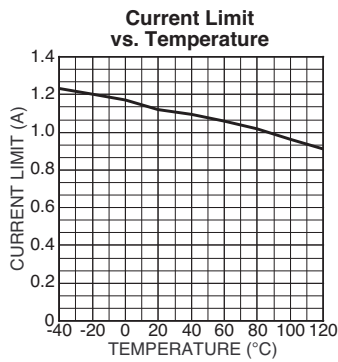
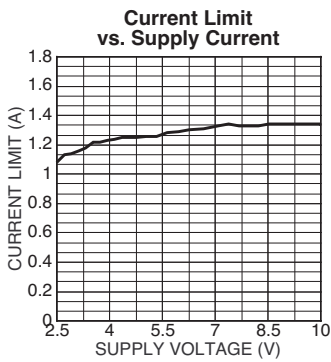
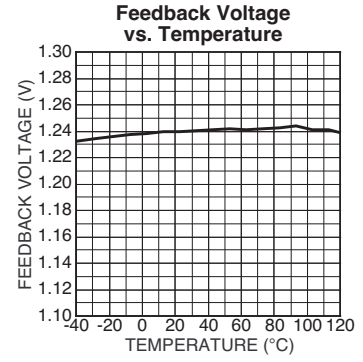
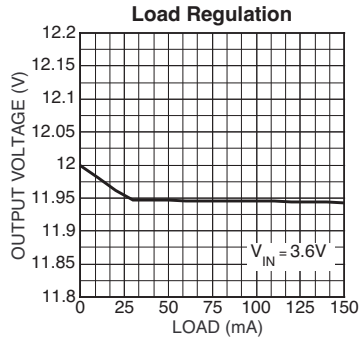
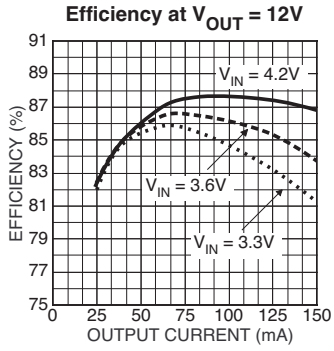

Function Characteristics

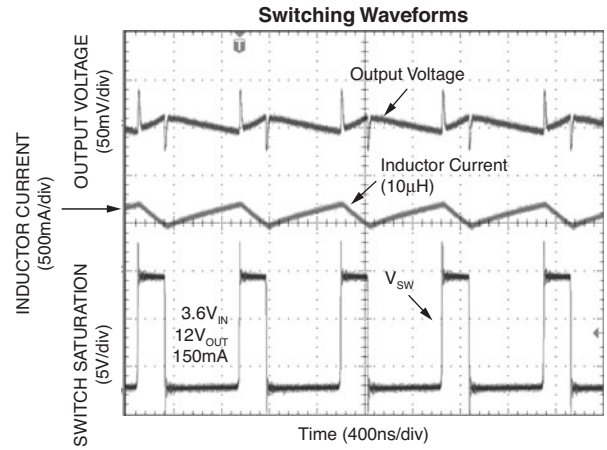
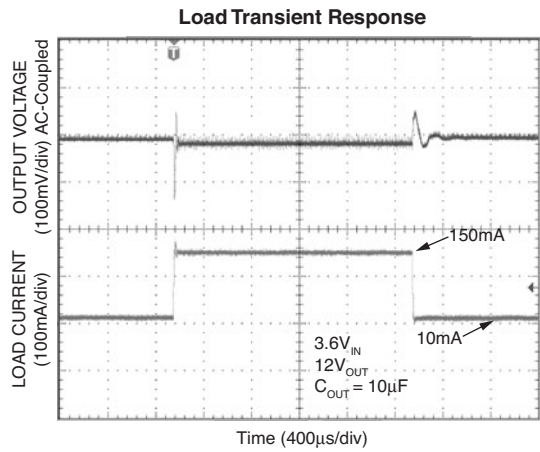
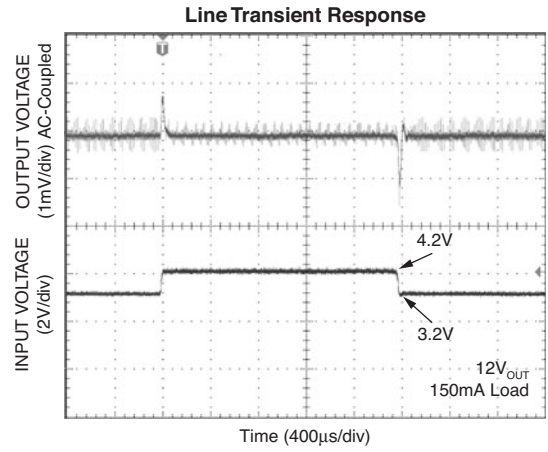
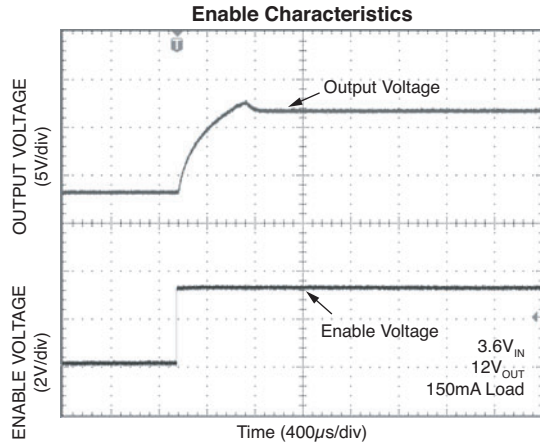

Functional Diagram

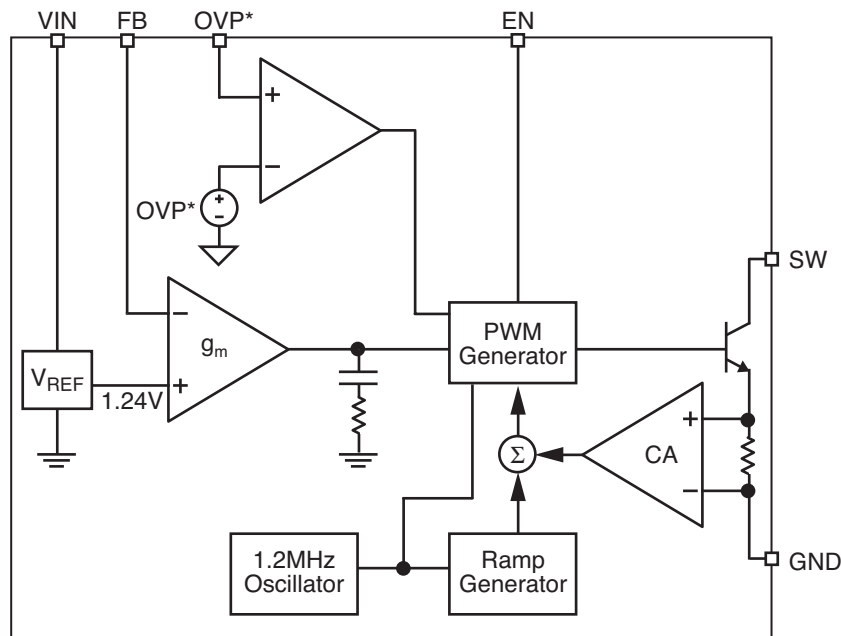

*OVP available on MLF™ package option only.

Figure 1. MIC2288 Block Diagram

Functional Description

The MIC2288 is a constant frequency, PWM current mode boost regulator. The block diagram is shown in Figure 1. The MIC2288 is composed of an oscillator, slope compensation ramp generator, current amplifier, g_m error amplifier, PWM generator, and a 1A bipolar output transistor. The oscillator generates a 1.2MHz clock. The clock's two functions are to trigger the PWM generator that turns on the output transistor, and to reset the slope compensation ramp generator. The current amplifier is used to measure the switch current by amplifying the voltage signal from the internal sense resistor. The output of the current amplifier is summed with the output of the slope compensation ramp generator. This summed current-loop signal is fed to one of the inputs of the PWM generator.

The g_m error amplifier measures the feedback voltage through the external feedback resistors and amplifies the error between the detected signal and the 1.24V reference voltage. The output of the g_m error amplifier provides the voltage-loop signal that is fed to the other input of the PWM generator. When the current-loop signal exceeds the voltage-loop signal, the PWM generator turns off the bipolar output transistor. The next clock period initiates the next switching cycle, maintaining the constant frequency current-mode PWM control.

Applications Information

DC-to-DC PWM Boost Conversion

The MIC2288 is a constant-frequency boost converter. It operates by taking a DC input voltage and regulating a higher DC output voltage. Figure 2 shows a typical circuit. Boost regulation is achieved by turning on an internal switch, which draws current through the inductor (L1). When the switch turns off, the inductor's magnetic field collapses, causing the current to be discharged into the output capacitor through an external Schottky diode (D1). Voltage regulation is achieved by modulating the pulse width or pulse-width modulation (PWM).

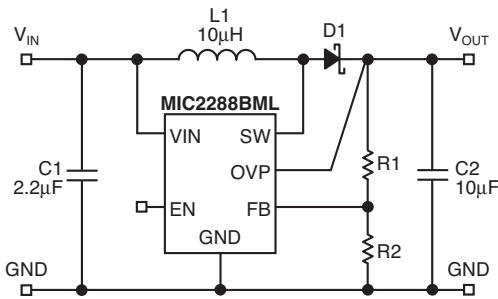

Figure 2. Typical Application Circuit

Duty Cycle Considerations

Duty cycle refers to the switch on-to-off time ratio and can be calculated as follows for a boost regulator:

$$D = 1 - \frac{V_{IN}}{V_{OUT}}$$

The duty cycle required for voltage conversion should be less than the maximum duty cycle of 85%. Also, in light load conditions where the input voltage is close to the output voltage, the minimum duty cycle can cause pulse skipping. This is due to the energy stored in the inductor causing the output to overshoot slightly over the regulated output voltage. During the next cycle, the error amplifier detects the output as being high and skips the following pulse. This effect can be reduced by increasing the minimum load or by increasing the inductor value. Increasing the inductor value reduces peak current, which in turn reduces energy transfer in each cycle.

Overvoltage Protection

For the MLF™ package option, there is an overvoltage protection function. If the feedback resistors are disconnected from the circuit or the feedback pin is shorted to ground, the feedback pin will fall to ground potential. This will cause the MIC2288 to switch at full duty cycle in an attempt to maintain the feedback voltage. As a result, the output voltage will climb out of control. This may cause the switch node voltage to exceed its maximum voltage rating, possibly damaging the IC and the external components. To ensure the highest level of protection, the MIC2288 OVP pin will shut the switch off when an overvoltage condition is detected, saving itself and other sensitive circuitry downstream.

Component Selection

Inductor

Inductor selection is a balance between efficiency, stability, cost, size, and rated current. For most applications a 10µH is the recommended inductor value. It is usually a good balance between these considerations.

Larger inductance values reduce the peak-to-peak ripple current, affecting efficiency. This has the effect of reducing both the DC losses and the transition losses. There is also a secondary effect of an inductor's DC resistance (DCR). The DCR of an inductor will be higher for more inductance in the same package size. This is due to the longer windings required for an increase in inductance. Since the majority of input current (minus the MIC2288 operating current) is passed through the inductor, higher DCR inductors will reduce efficiency.

To maintain stability, increasing inductor size will have to be met with an increase in output capacitance. This is due to the unavoidable "right half plane zero" effect for the continuous current boost converter topology. The frequency at which the right half plane zero occurs can be calculated as follows:

$$F_{rhpz} = \frac{V_{IN}^2}{V_{OUT} \times L \times I_{OUT} \times 2\pi}$$

The right half plane zero has the undesirable effect of increasing gain, while decreasing phase. This requires that the loop gain is rolled off before this has significant effect on the total loop response. This can be accomplished by either reducing inductance (increasing RHPZ frequency) or increasing the output capacitor value (decreasing loop gain).

Output Capacitor

Output capacitor selection is also a trade-off between performance, size, and cost. Increasing output capacitance will lead to an improved transient response, but also an increase in size and cost. X5R or X7R dielectric ceramic capacitors are recommended for designs with the MIC2288. Y5V values may be used but to offset their tolerance over temperature, more capacitance is required. The following table shows the recommended ceramic (X5R) output capacitor value vs. output voltage.

Output Voltage	Recommended Output Capacitance
<6V	22µF
<16V	10µF
<34V	4.7µF

Table 1. Output Capacitor Selection

Diode Selection

The MIC2288 requires an external diode for operation. A Schottky diode is recommended for most applications due to their lower forward voltage drop and reverse recovery time. Ensure the diode selected can deliver the peak inductor current and the maximum reverse voltage is rated greater than the output voltage.

Input capacitor

A minimum 1 μ F ceramic capacitor is recommended for designing with the MIC2288. Increasing input capacitance will improve performance and greater noise immunity on the source. The input capacitor should be as close as possible to the inductor and the MIC2288, with short traces for good noise performance.

Feedback Resistors

The MIC2288 utilizes a feedback pin to compare the output to an internal reference. The output voltage is adjusted by selecting the appropriate feedback resistor network values. The R2 resistor value must be less than or equal to 5k Ω ($R2 \leq 5k\Omega$). The desired output voltage can be calculated as follows:

$$V_{OUT} = V_{REF} \times \left(\frac{R1}{R2} + 1 \right)$$

where V_{REF} is equal to 1.24V.

Application Circuits

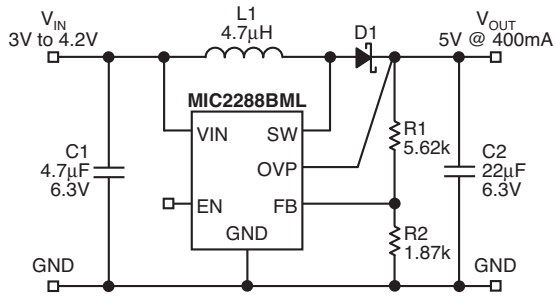

C1	4.7µF, 6.3V, 0805 X5R Ceramic Capacitor	08056D475MAT	AVX
C2	22µF, 6.3V, 0805 X5R Ceramic Capacitor	12066D226MAT	AVX
D1	1A, 40V Schottky Diode	MBRM140T3	ON Semi.
L1	4.7µH, 650mA Inductor	LQH32CN4R7M11	Murata

Figure 3. 3.3V_{IN} to 5V_{OUT} @ 400mA

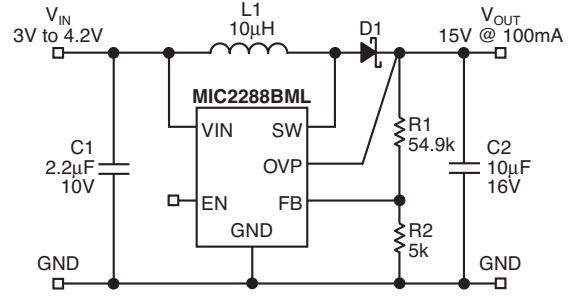

C1	2.2µF, 10V, 0805 X5R Ceramic Capacitor	08052D225KAT	AVX
C2	10µF, 16V, 1206 X5R Ceramic Capacitor	1206YD106MAT	AVX
D1	1A, 40V Schottky Diode	MBRM140T3	ON Semi.
L1	10µH, 650mA Inductor	LQH43CN100K03	Murata

Figure 6. 3.3V_{IN} – 4.2V_{IN} to 15V_{OUT} @ 100mA

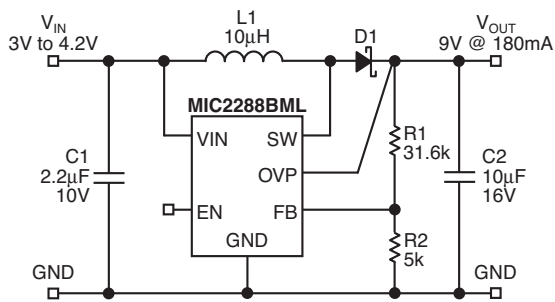

C1	2.2µF, 10V, 0805 X5R Ceramic Capacitor	08052D225KAT	AVX
C2	10µF, 16V, 1206 X5R Ceramic Capacitor	1206YD106MAT	AVX
D1	1A, 40V Schottky Diode	MBRM140T3	ON Semi.
L1	10µH, 650mA Inductor	LQH43CN100K03	Murata

Figure 4. 3.3V_{IN} – 4.2V_{IN} to 9V_{OUT} @ 180mA

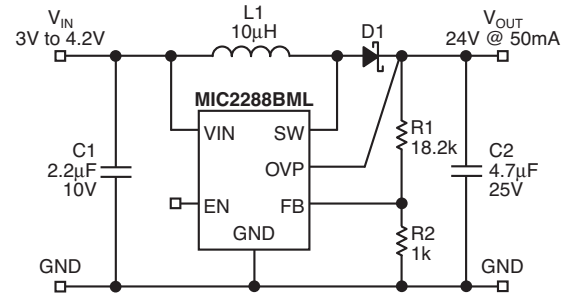

C1	2.2µF, 10V, 0805 X5R Ceramic Capacitor	08052D225KAT	AVX
C2	4.7µF, 25V, 1206 X5R Ceramic Capacitor	12063D475MAT	AVX
D1	1A, 40V Schottky Diode	MBRM140T3	ON Semi.
L1	10µH, 650mA Inductor	LQH43CN100K03	Murata

Figure 7. 3.3V_{IN} – 4.2V_{IN} to 24V_{OUT} @ 50mA

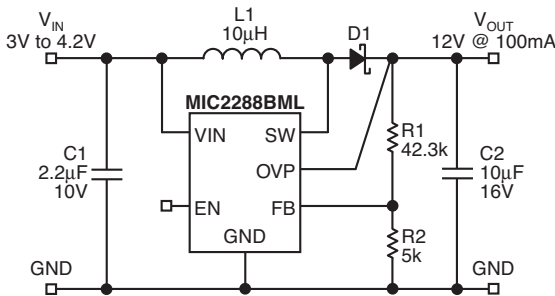

C1	2.2µF, 10V, 0805 X5R Ceramic Capacitor	08052D225KAT	AVX
C2	10µF, 16V, 1206 X5R Ceramic Capacitor	1206YD106MAT	AVX
D1	1A, 40V Schottky Diode	MBRM140T3	ON Semi.
L1	10µH, 650mA Inductor	LQH43CN100K03	Murata

Figure 5. 3.3V_{IN} – 4.2V_{IN} to 12V_{OUT} @ 100mA

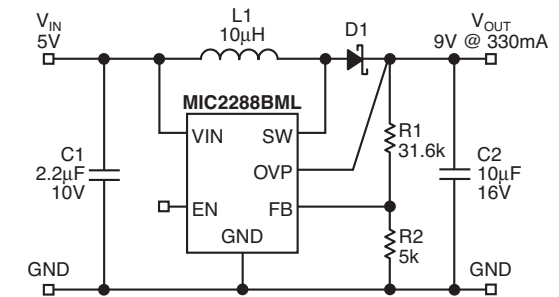

C1	2.2µF, 10V, 0805 X5R Ceramic Capacitor	08052D225KAT	AVX
C2	10µF, 16V, 1206 X5R Ceramic Capacitor	1206YD106MAT	AVX
D1	1A, 40V Schottky Diode	MBRM140T3	ON Semi.
L1	10µH, 650mA Inductor	LQH43CN100K03	Murata

Figure 8. 5V_{IN} to 9V_{OUT} @ 330mA

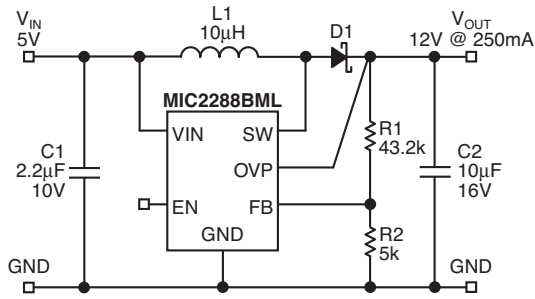

C1	2.2µF, 10V, 0805 X5R Ceramic Capacitor	08052D225KAT	AVX
C2	10µF, 16V, 1206 X5R Ceramic Capacitor	1206YD106MAT	AVX
D1	1A, 40V Schottky Diode	MBRM140T3	ON Semi.
L1	10µH, 650mA Inductor	LQH43CN100K03	Murata

Figure 9. 5V_{IN} to 12V_{OUT} @ 250mA

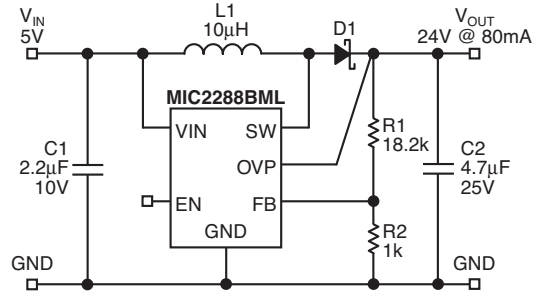

C1	2.2µF, 10V, 0805 X5R Ceramic Capacitor	08052D225KAT	AVX
C2	4.7µF, 25V, 1206 X5R Ceramic Capacitor	12066D475MAT	AVX
D1	1A, 40V Schottky Diode	MBRM140T3	ON Semi.
L1	10µH, 650mA Inductor	LQH32CN4R7M11	Murata

Figure 10. 5V_{IN} to 24V_{OUT} @ 80mA

Package Information

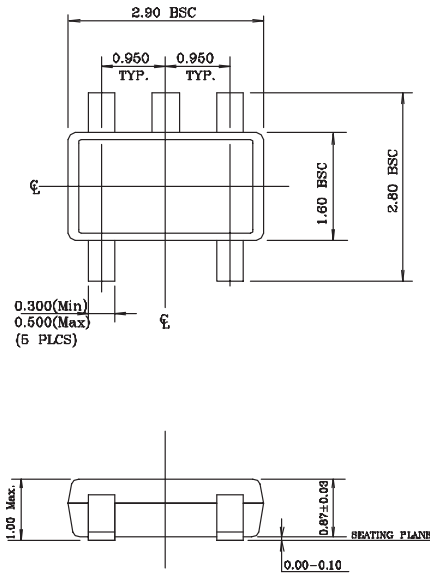

All Dimensions are in millimeters

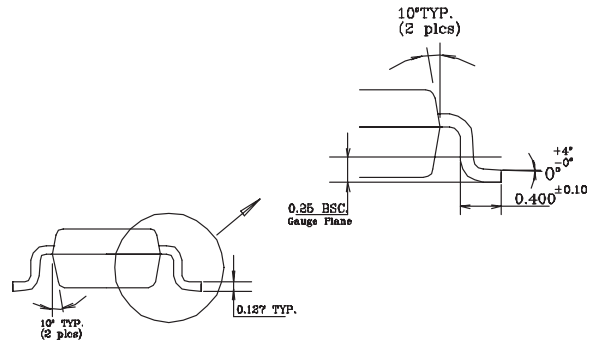

5-Pin TSOT (D5)

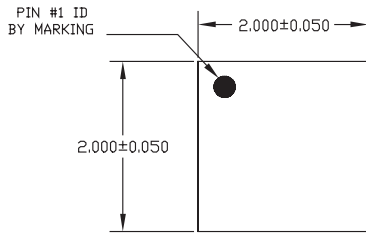

TOP VIEW

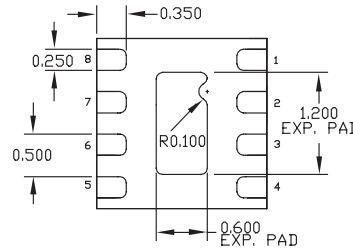

BOTTOM VIEW

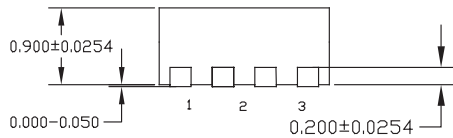

SIDE VIEW

- NOTE:
1. ALL DIMENSIONS ARE IN MILLIMETERS.
 2. MAX. PACKAGE WARPAGE IS 0.05 mm.
 3. MAXIMUM ALLOWABLE BURRS IS 0.076 mm IN ALL DIRECTIONS.
 4. PIN #1 ID ON TOP WILL BE LASER/INK MARKED.

8-Pin MLF™ (ML)

MICREL INC. 2180 FORTUNE DRIVE SAN JOSE, CA 95131 USA

TEL + 1 (408) 944-0800 FAX + 1 (408) 474-1000 WEB <http://www.micrel.com>

This information furnished by Micrel in this data sheet is believed to be accurate and reliable. However no responsibility is assumed by Micrel for its use. Micrel reserves the right to change circuitry and specifications at any time without notification to the customer.

Micrel Products are not designed or authorized for use as components in life support appliances, devices or systems where malfunction of a product can reasonably be expected to result in personal injury. Life support devices or systems are devices or systems that (a) are intended for surgical implant into the body or (b) support or sustain life, and whose failure to perform can be reasonably expected to result in a significant injury to the user. A Purchaser's use or sale of Micrel Products for use in life support appliances, devices or systems is a Purchaser's own risk and Purchaser agrees to fully indemnify Micrel for any damages resulting from such use or sale.

© 2004 Micrel, Incorporated.