



MIC94040/1/2/3

28m Ω R_{DS(on)} 3A High Side Load Switch
in 1.2mm x 1.2mm MLF[®] package

General Description

The MIC94040/1/2/3 is a family of high-side load switches designed to operate from 1.7V to 5.5V input voltage. The load switch pass element is an internal 28m Ω R_{DS(on)} P-channel MOSFET which enables the device to support up to 3A of continuous current. Additionally, the load switch supports 1.5V logic level control and shutdown features in a tiny 1.2mm x 1.2mm 4 pin MLF[®] package.

The MIC94040 and MIC94041 feature rapid turn on, while the MIC94042 and MIC94043 provide a slew rate controlled soft-start turn-on of 100 μ s. The soft-start feature is provided to prevent an in-rush current event from pulling down the input supply voltage.

The MIC94041 and MIC94043 feature an active load discharge circuit which switches in a 200 Ω load when the switch is disabled to automatically discharge a capacitive load.

An active pull-down on the enable input keeps the MIC94040/1/2/3 in a default OFF state until the enable pin is pulled above 1.2V. Internal level shift circuitry allows low voltage logic signals to switch higher supply voltages. The enable voltage can be as high as 5.5V and is not limited by the input voltage.

The MIC94040/1/2/3 operating voltage range makes them ideal for Lithium ion and NiMH/NiCad/Alkaline battery powered systems, as well as non-battery powered applications. The devices provide low quiescent current and low shutdown current to maximize battery life.

Datasheets and support documentation can be found on Micrel's web site at: www.micrel.com.

Features

- 28m Ω R_{DS(on)}
- 3A continuous operating current
- 1.2mm x 1.2mm space saving 4-pin MLF[®] package
- 1.7V to 5.5V input voltage range
- Internal level shift for CMOS/TTL control logic
- Ultra low quiescent current
- Micro-power shutdown current
- Soft-Start: MIC94042, MIC94043
- Load discharge circuit: MIC94041, MIC94043
- Ultra fast turn off time
- Junction operating temperature from -40 $^{\circ}$ C to +125 $^{\circ}$ C

Applications

- Cellular phones
- Portable Navigation Devices (PND)
- Personal Media Players (PMP)
- Ultra Mobile PCs
- Portable instrumentation
- Other Portable applications
- PDAs
- Industrial and DataComm equipment

Typical Application

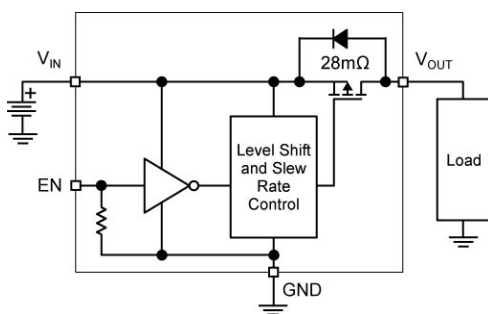

MIC94040 (ultra fast turn on)
MIC94042 (soft-start)

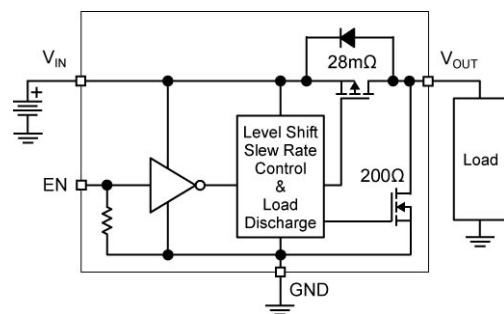

MIC94041 (ultra fast turn on with auto-discharge)
MIC94043 (soft-start with auto-discharge)

MLF and MicroLeadFrame is a registered trademark of Amkor Technology, Inc.

Micrel Inc. • 2180 Fortune Drive • San Jose, CA 95131 • USA • tel +1 (408) 944-0800 • fax +1 (408) 474-1000 • <http://www.micrel.com>

Ordering Information

| Part Number | Part Marking ⁽¹⁾ | Fast Turn On | Soft-Start | Load Discharge | Package ⁽²⁾ |
|-------------|-----------------------------|--------------|------------|----------------|--|
| MIC94040YFL | — P4 | • | | | 4-Pin (1.2mm x 1.2mm) MLF [®] |
| MIC94041YFL | — P1 | • | | • | 4-Pin (1.2mm x 1.2mm) MLF [®] |
| MIC94042YFL | — P2 | | • | | 4-Pin (1.2mm x 1.2mm) MLF [®] |
| MIC94043YFL | — P3 | | • | • | 4-Pin (1.2mm x 1.2mm) MLF [®] |

Notes:

1. MLF[®] Pin 1 Identifier symbol is “•”.
2. MLF[®] is a GREEN RoHS-compliant package. Lead finish is NiPdAu. Mold compound is Halogen Free.

Pin Configuration

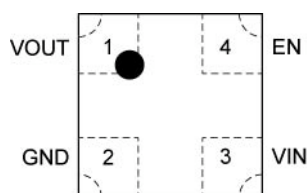

Top View

4-Pin (1.2mm x 1.2mm) MLF[®]

Pin Description

| Pin Number | Pin Name | Pin Function |
|------------|------------------|---|
| 1 | V _{OUT} | Drain of P-channel MOSFET. |
| 2 | GND | Ground should be connected to electrical ground. |
| 3 | V _{IN} | Source of P-channel MOSFET. |
| 4 | EN | Enable (Input): Active-high CMOS/TTL control input for switch. Internal ~2M Ω Pull down resistor. Output will be off if this pin is left floating. |

Absolute Maximum Ratings⁽¹⁾

| | |
|---|-------------------|
| Input Voltage (V_{IN}) | +6V |
| Enable Voltage (V_{EN}) | +6V |
| Continuous Drain Current (I_D) ⁽³⁾ | |
| $T_A = 25^\circ\text{C}$ | $\pm 3\text{A}$ |
| $T_A = 85^\circ\text{C}$ | $\pm 2\text{A}$ |
| Pulsed Drain Current (I_{DP}) ⁽⁴⁾ | $\pm 6.0\text{A}$ |
| Continuous Diode Current (I_S) ⁽⁵⁾ | -50mA |
| Storage Temperature (T_S) | -55°C to +150°C |
| ESD Rating – HBM ⁽⁶⁾ | 3kV |

Operating Ratings⁽²⁾

| | |
|------------------------------------|-----------------|
| Input Voltage (V_{IN}) | +1.7 to +5.5V |
| Junction Temperature (T_J) | -40°C to +125°C |
| Package Thermal Resistance | |
| MLF [®] (θ_{JC}) | 90°C/W |

Electrical Characteristics

$T_A = 25^\circ\text{C}$, bold values indicate $-40^\circ\text{C} \leq T_A \leq +85^\circ\text{C}$, unless noted.

| Symbol | Parameter | Condition | Min | Typ | Max | Units |
|-------------------|---|---|------------|-----|------------|---------------|
| V_{EN_TH} | Enable Threshold Voltage | $V_{IN} = 1.7\text{V to } 4.5\text{V}$, $I_D = -250\mu\text{A}$ | 0.4 | | 1.2 | V |
| I_Q | Quiescent Current | $V_{IN} = V_{EN} = 5.5\text{V}$, $I_D = \text{OPEN}$ Measured on V_{IN} MIC94040, MIC94041 | | 0.1 | 1 | μA |
| | | $V_{IN} = V_{EN} = 5.5\text{V}$, $I_D = \text{OPEN}$ Measured on V_{IN} MIC94042, MIC94043 | | 7 | 10 | |
| I_{EN} | Enable Input Current | $V_{IN} = V_{EN} = 5.5\text{V}$, $I_D = \text{OPEN}$ | | 2.5 | 4 | μA |
| I_{SHUT-Q} | Quiescent Current (shutdown) | $V_{IN} = +5.5\text{V}$, $V_{EN} = 0\text{V}$, $I_D = \text{OPEN}$ Measured on V_{IN} | | 0.1 | 1 | μA |
| $I_{SHUT-SWITCH}$ | OFF State Leakage Current | $V_{IN} = +5.5\text{V}$, $V_{EN} = 0\text{V}$, $I_D = \text{SHORT}$ Measured on V_{OUT} , ⁽⁷⁾ | | 0.1 | 1 | μA |
| $R_{DS(ON)}$ | P-Channel Drain to Source ON Resistance | $V_{IN} = +5.0\text{V}$, $I_D = -100\text{mA}$, $V_{EN} = 1.5\text{V}$ | | 28 | 55 | m Ω |
| | | $V_{IN} = +4.5\text{V}$, $I_D = -100\text{mA}$, $V_{EN} = 1.5\text{V}$ | | 30 | 60 | m Ω |
| | | $V_{IN} = +3.6\text{V}$, $I_D = -100\text{mA}$, $V_{EN} = 1.5\text{V}$ | | 33 | 65 | m Ω |
| | | $V_{IN} = +2.5\text{V}$, $I_D = -100\text{mA}$, $V_{EN} = 1.5\text{V}$ | | 45 | 90 | m Ω |
| | | $V_{IN} = +1.8\text{V}$, $I_D = -100\text{mA}$, $V_{EN} = 1.5\text{V}$ | | 72 | 145 | m Ω |
| | | $V_{IN} = +1.7\text{V}$, $I_D = -100\text{mA}$, $V_{EN} = 1.5\text{V}$ | | 82 | 160 | m Ω |
| $R_{SHUTDOWN}$ | Turn-Off Resistance (MIC94041, MIC94043) | $V_{IN} = +3.6\text{V}$, $I_{TEST} = 1\text{mA}$, $V_{EN} = 0\text{V}$ | | 250 | 400 | Ω |

Notes:

- Exceeding the absolute maximum rating may damage the device.
- The device is not guaranteed to function outside its operating rating.
- With thermal contact to PCB. See thermal considerations section.
- Pulse width <300 μs with < 2% duty cycle.
- Continuous body diode current conduction (reverse conduction, i.e. V_{OUT} to V_{IN}) is not recommended.
- Devices are ESD sensitive. Handling precautions recommended. HBM (Human body model), 1.5k Ω in series with 100pF.
- Measured on the MIC94040YFL and MIC94042YFL.

Electrical Characteristics (Dynamic)

$T_A = 25^\circ\text{C}$, bold values indicate $-40^\circ\text{C} \leq T_A \leq +85^\circ\text{C}$, unless noted.

| Symbol | Parameter | Condition | Min | Typ | Max | Units |
|------------------------|---------------------|---|-----|------|-----|---------------|
| $t_{\text{ON_DLY}}$ | Turn-On Delay Time | $V_{\text{IN}} = +3.6\text{V}$, $I_{\text{D}} = -100\text{mA}$, $V_{\text{EN}} = 1.5\text{V}$ MIC94040, MIC94041 | | 0.97 | 1.5 | μs |
| | | $V_{\text{IN}} = +3.6\text{V}$, $I_{\text{D}} = -100\text{mA}$, $V_{\text{EN}} = 1.5\text{V}$ MIC94042, MIC94043 | 50 | 106 | 185 | μs |
| $t_{\text{ON_RISE}}$ | Turn-On Rise Time | $V_{\text{IN}} = +3.6\text{V}$, $I_{\text{D}} = -100\text{mA}$, $V_{\text{EN}} = 1.5\text{V}$ MIC94040, MIC94041 | 0.5 | 0.9 | 5 | μs |
| | | $V_{\text{IN}} = +3.6\text{V}$, $I_{\text{D}} = -100\text{mA}$, $V_{\text{EN}} = 1.5\text{V}$ MIC94042, MIC94043 | 50 | 116 | 200 | μs |
| $t_{\text{OFF_DLY}}$ | Turn-Off Delay Time | $V_{\text{IN}} = +3.6\text{V}$, $I_{\text{D}} = -100\text{mA}$, $V_{\text{EN}} = 0\text{V}$ | | 100 | 200 | ns |
| $t_{\text{OFF_FALL}}$ | Turn-Off Fall Time | $V_{\text{IN}} = +3.6\text{V}$, $I_{\text{D}} = -100\text{mA}$, $V_{\text{EN}} = 0\text{V}$ | | 20 | 100 | ns |

Typical Characteristics

MIC94040/1/2/3

$R_{DS(on)}$ Variance vs. Temperature

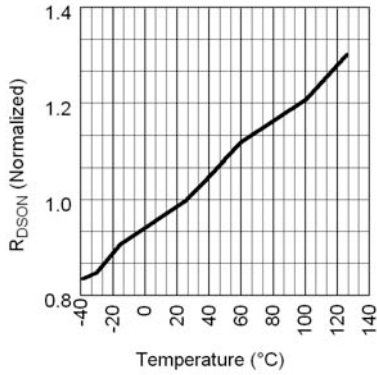

MIC94040/1/2/3

Voltage Drop vs. Load Current

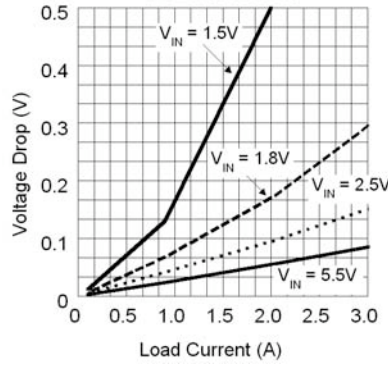

MIC94040/1/2/3

On Resistance vs. Input Voltage

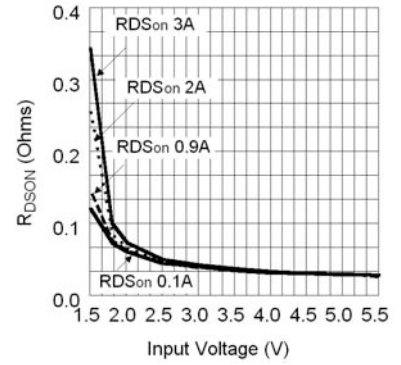

MIC94040/1

Enable Threshold vs. Input Voltage

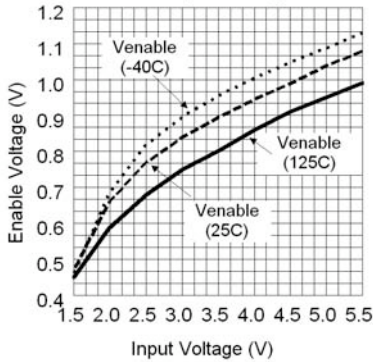

MIC94042/3

Enable Threshold vs. Input Voltage

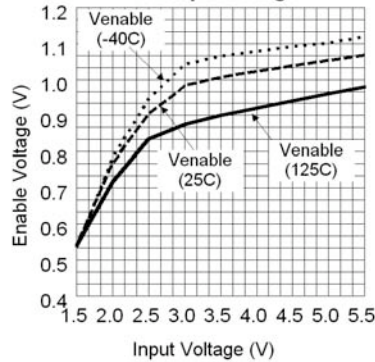

MIC94040/41

Quiescent Current vs. Temperature

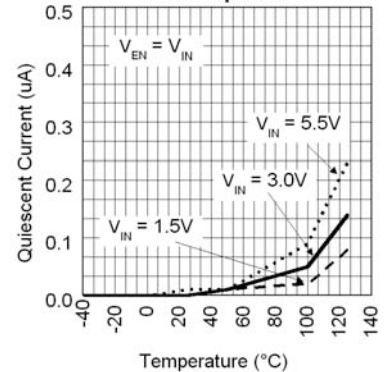

MIC94042/3

Quiescent Current vs. Temperature

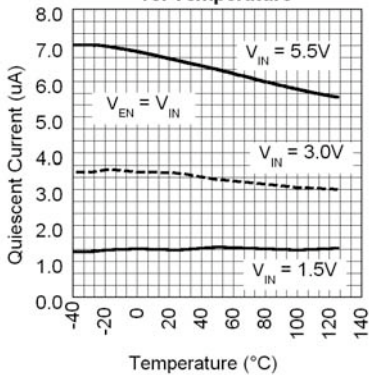

MIC94042/3

Enable Current vs. Temperature

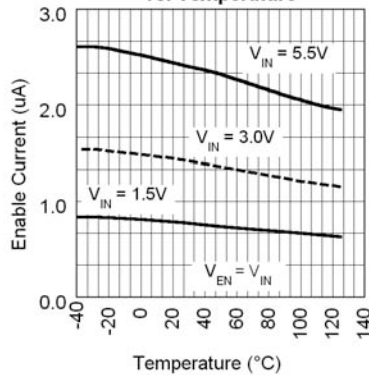

MIC94040/1

T_{ON} Delay vs. Input Voltage

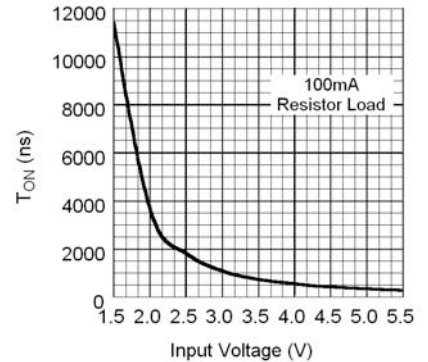

Typical Characteristics

MIC94042/3

T_{ON} Delay vs. Input Voltage

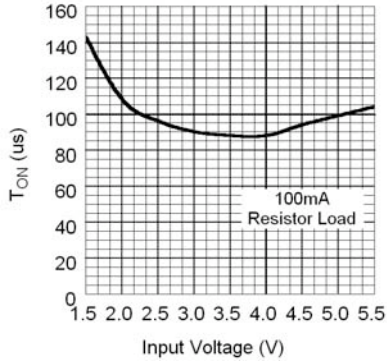

MIC94040/1

Rise Time vs. Input Voltage

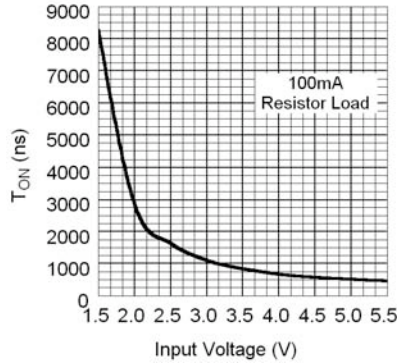

MIC94042/3

Rise Time vs. Input Voltage

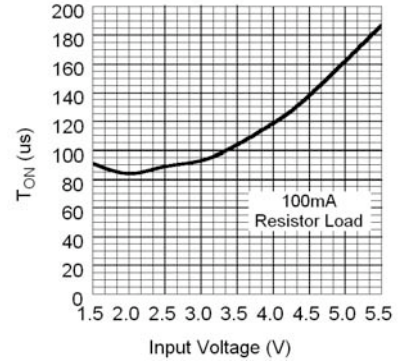

MIC94040/1

Turn on Rise Time vs. Temperature

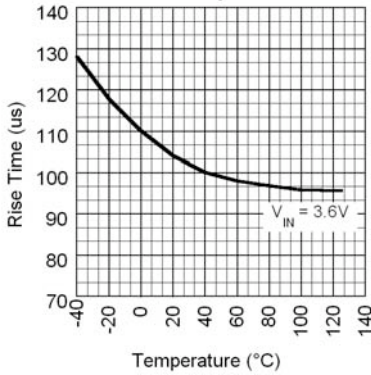

MIC94042/3

T_{OFF} Delay vs. Input Voltage

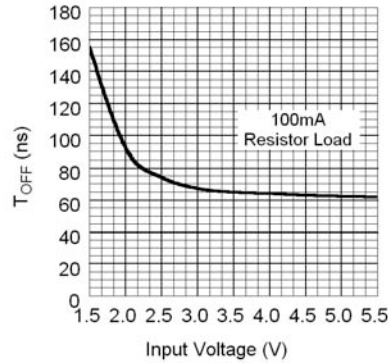

MIC94040/1/2/3

T_{OFF} Delay vs. Input Voltage

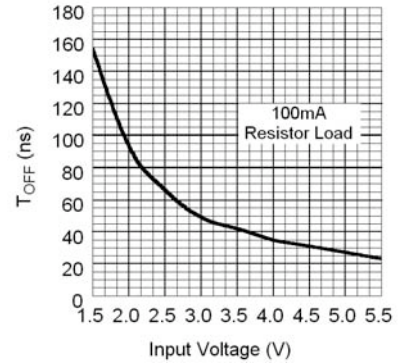

MIC94042/3

Fall Time vs. Input Voltage

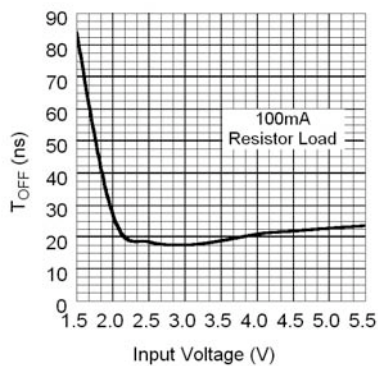

Functional Characteristics

MIC94040

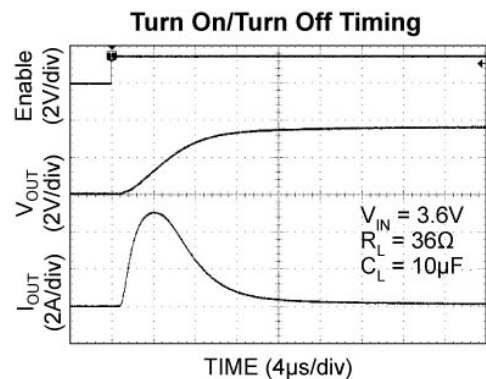
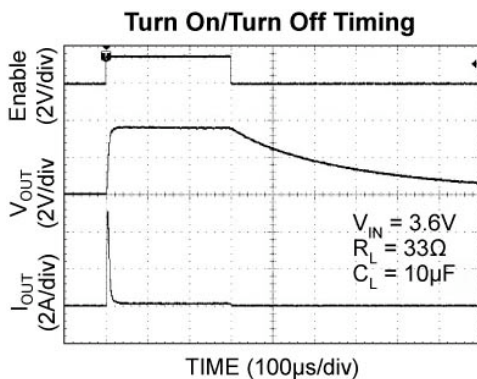
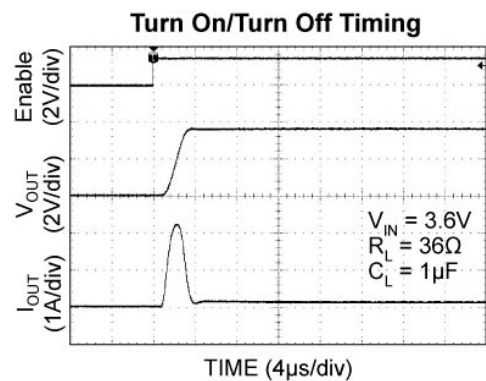
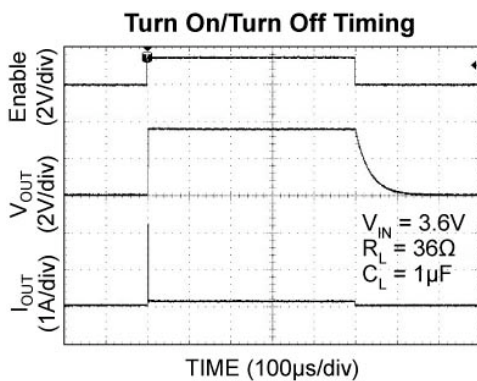
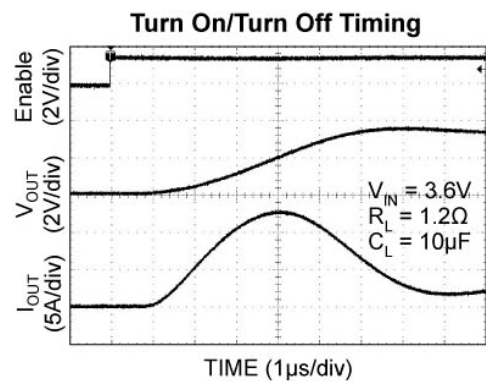
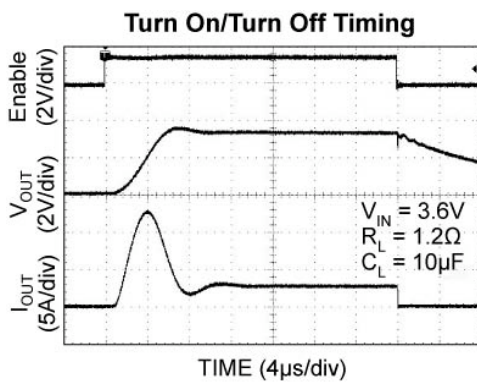
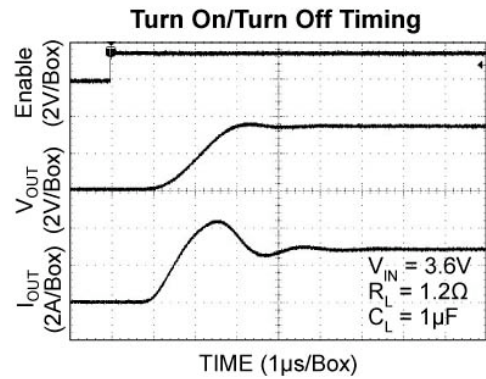
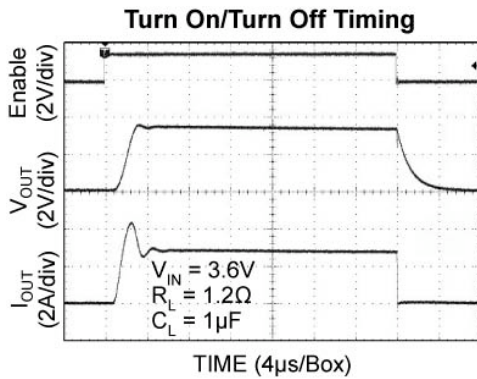

MIC94041

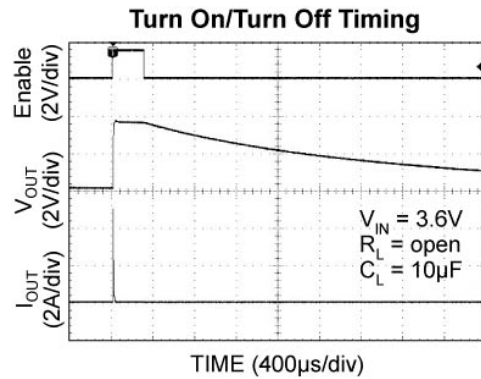
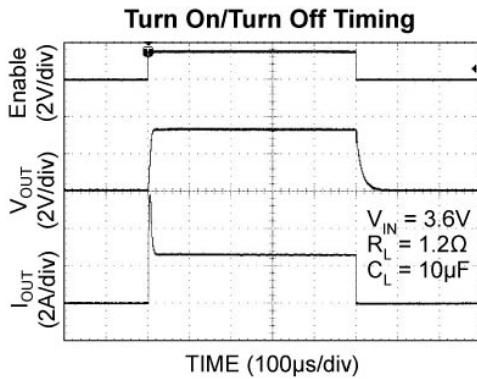
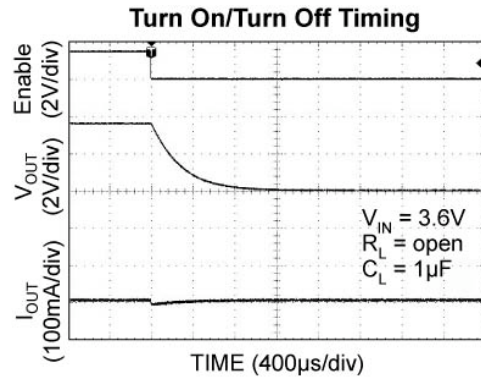
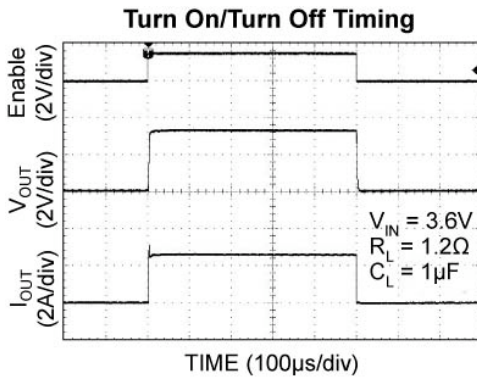
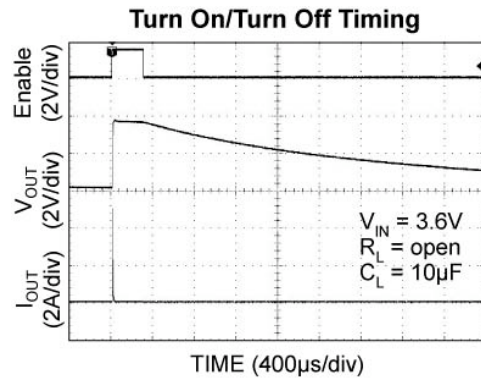
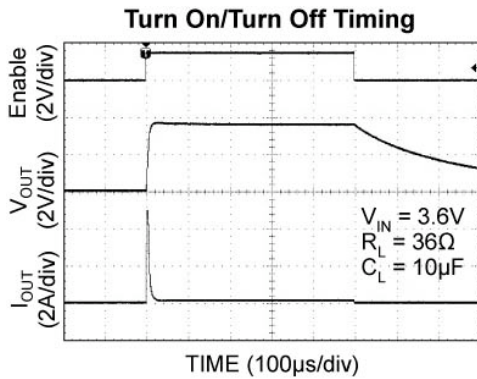
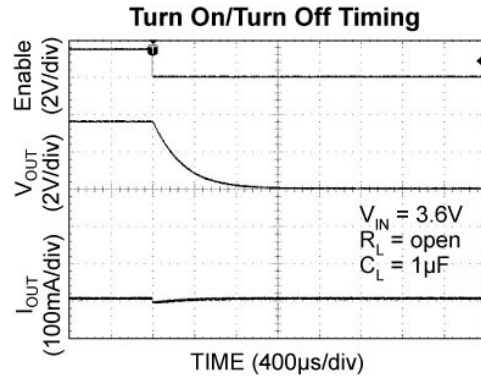
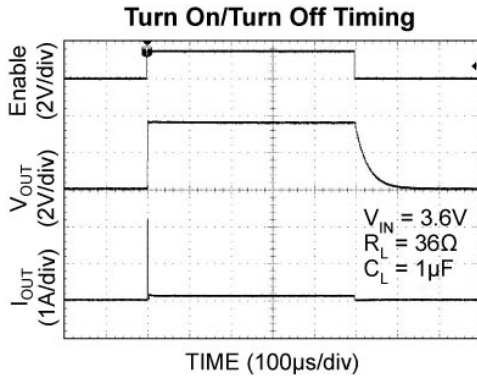

MIC94042

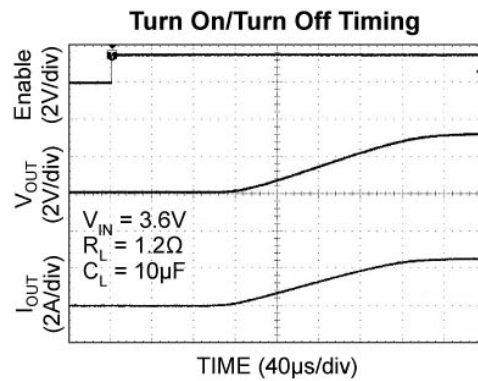
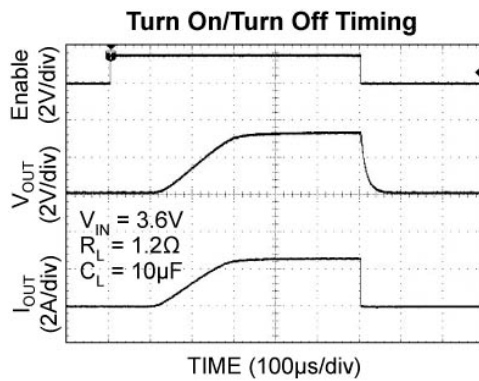
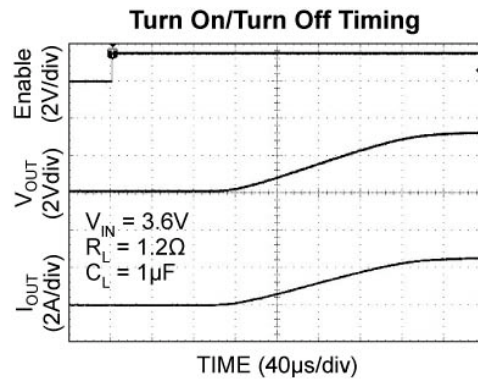
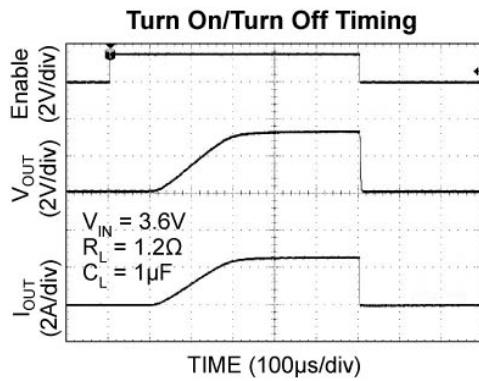
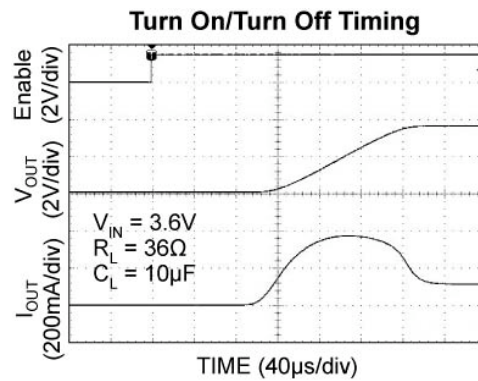
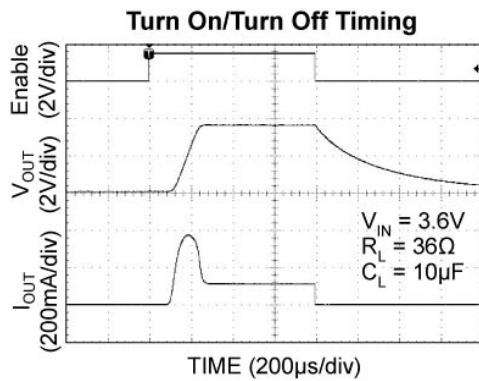
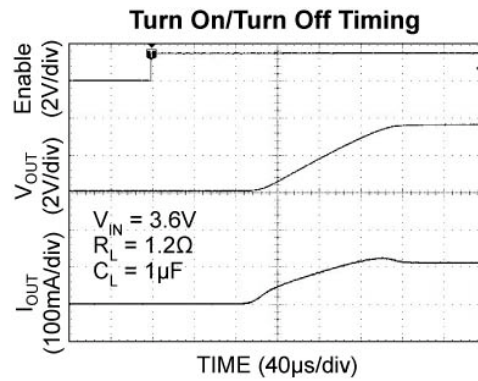
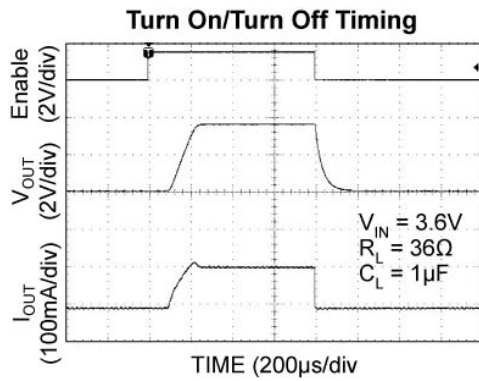

MIC94043

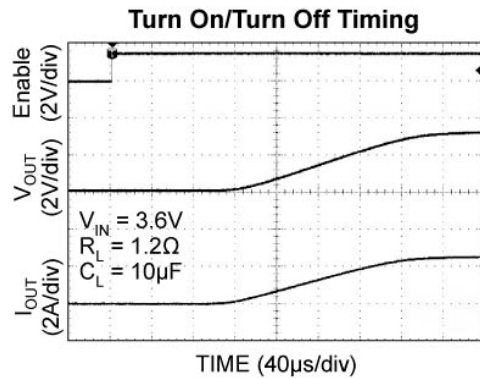
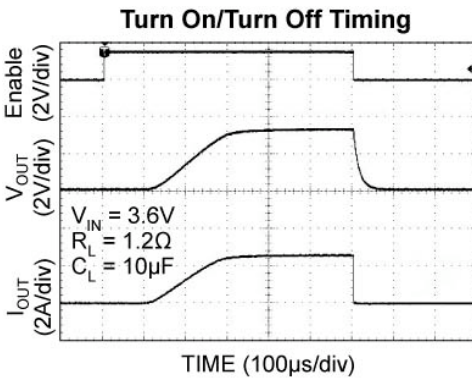
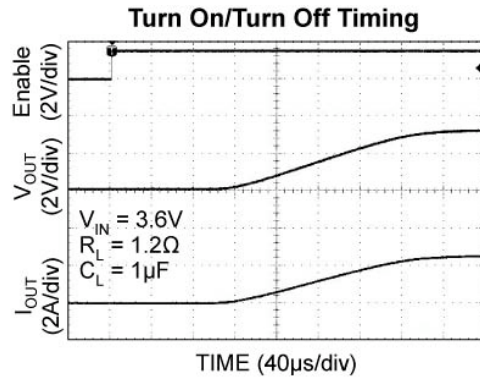
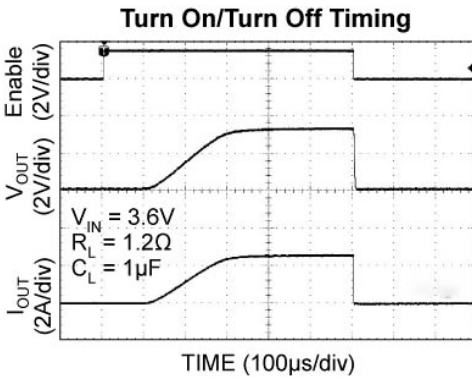
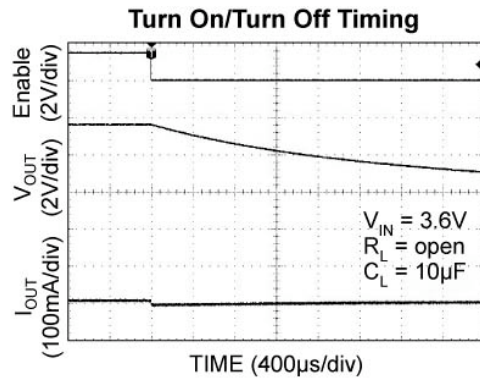
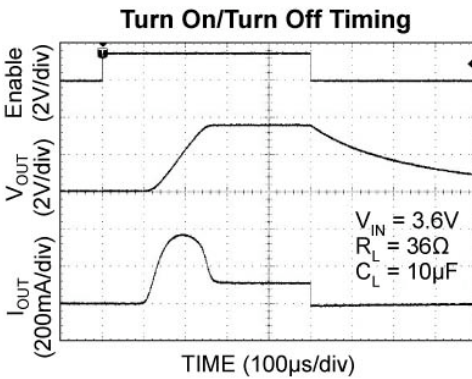
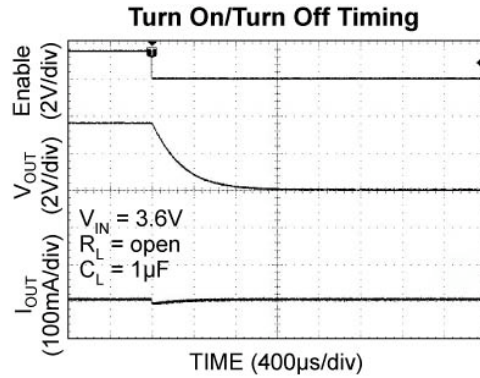
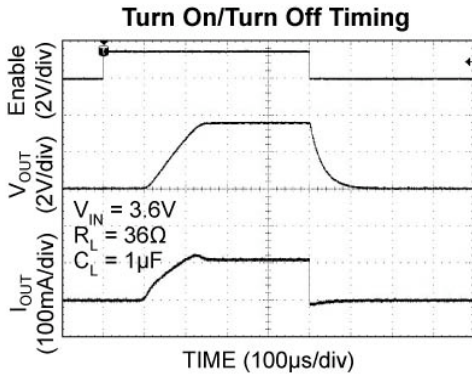

Application Information

Power Dissipation Considerations

As with all power switches, the current rating of the switch is limited mostly by the thermal properties of the package and the PCB it is mounted on. There is a simple ohms law type relationship between thermal resistance, power dissipation and temperature, which are analogous to an electrical circuit:

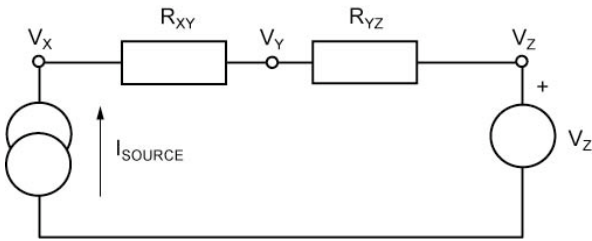

Figure 1. Simple Electrical Circuit

From this simple circuit we can calculate V_x if we know I_{source} , V_z and the resistor values, R_{xy} and R_{yz} using the equation:

$$V_x = I_{source} \cdot (R_{xy} + R_{yz}) + V_z$$

Thermal circuits can be considered using these same rules and can be drawn similarly by replacing current sources with power dissipation (in Watts), resistance with thermal resistance (in $^{\circ}C/W$) and voltage sources with temperature (in $^{\circ}C$).

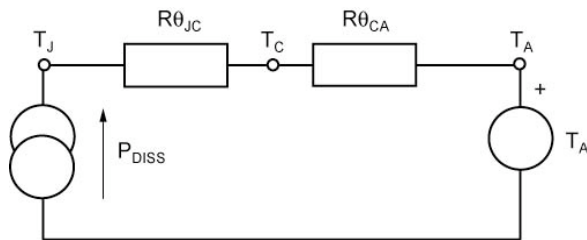

Figure 2. Simple Thermal Circuit

Now replacing the variables in the equation for V_x , we can find the junction temperature (T_J) from power dissipation, ambient temperature and the known thermal resistance of the PCB ($R_{\theta_{CA}}$) and the package ($R_{\theta_{JC}}$).

$$T_J = P_{DISS} \times (R_{\theta_{JC}} + R_{\theta_{CA}}) + T_A$$

P_{DISS} is calculated as $I_{SWITCH}^2 \times R_{SWmax}$. $R_{\theta_{JC}}$ is found in the operating ratings section of the datasheet and $R_{\theta_{CA}}$ (the PCB thermal resistance) values for various PCB copper areas is discussed in the document "Designing with Low Dropout Voltage Regulators" available from the Micrel website (LDO Application Hints).

Example:

A switch is intended to drive a 2A load and is placed on a printed circuit board which has a ground plane area of at least 25mm by 25mm ($625mm^2$). The Voltage source is a Li-ion battery with a lower operating threshold of 3V and the ambient temperature of the assembly can be up to $50^{\circ}C$.

Summary of variables:

$$I_{SW} = 2A$$

$$V_{IN} = 3V \text{ to } 4.2V$$

$$T_A = 50^{\circ}C$$

$$R_{\theta_{JC}} = 90^{\circ}C/W \text{ from Datasheet}$$

$$R_{\theta_{CA}} = 53^{\circ}C/W \text{ Read from Graph in Figure 3}$$

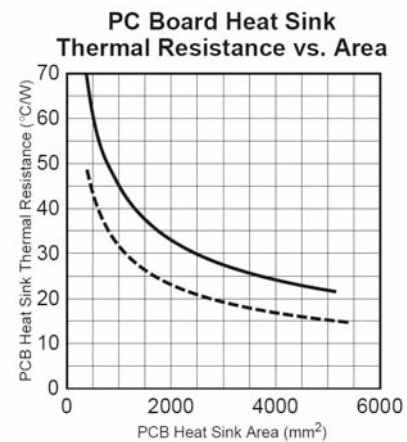

Figure 3. Excerpt from the LDO Book

$$P_{DISS} = I_{SW}^2 \times R_{SWmax}$$

The worst case switch resistance (R_{SWmax}) at the lowest V_{IN} of 3V is not available in the datasheet, so the next lower value of V_{IN} is used.

$$R_{SWmax} @ 2.5v = 90m\Omega$$

If this were a figure for worst case R_{SWmax} for $25^{\circ}C$, an additional consideration is to allow for the maximum junction temperature of $125^{\circ}C$, the actual worst case resistance in this case can be 30% higher (See $R_{DS(on)}$ variance vs. temperature graph). However, $90m\Omega$ is the maximum over temperature.

Therefore:

$$T_J = 2^2 \times 0.090 \times (90+53) + 50$$

$$T_J = 101^{\circ}C$$

This is below the maximum $125^{\circ}C$.

Package Information

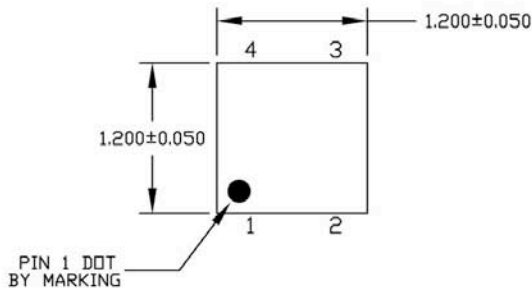

TOP VIEW

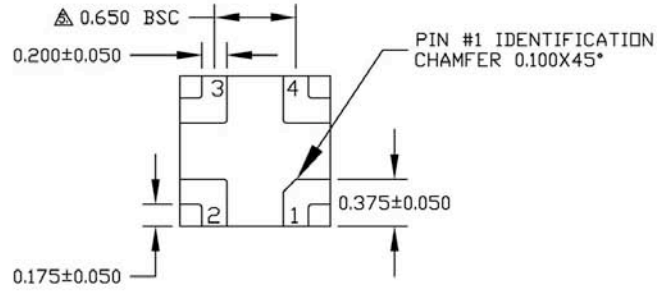

BOTTOM VIEW

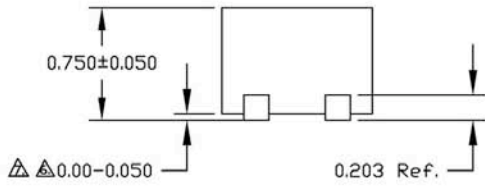

SIDE VIEW

NOTE:

1. ALL DIMENSIONS ARE IN MILLIMETERS.
 2. MAX. PACKAGE WARPAGE IS 0.05 mm.
 3. MAXIMUM ALLOWABLE BURRS IS 0.076 mm IN ALL DIRECTIONS.
 4. PIN #1 ID ON TOP WILL BE LASER/INK MARKED.
- Δ DIMENSION APPLIES TO METALIZED TERMINAL AND IS MEASURED BETWEEN 0.20 AND 0.25 mm FROM TERMINAL TIP.
 Δ APPLIED ONLY FOR TERMINALS.
 Δ APPLIED FOR EXPOSED PAD AND TERMINALS.

4-Pin (1.2mm x 1.2mm) MLF[®]

All units are in mm
Tolerance ± 0.05 if not noted

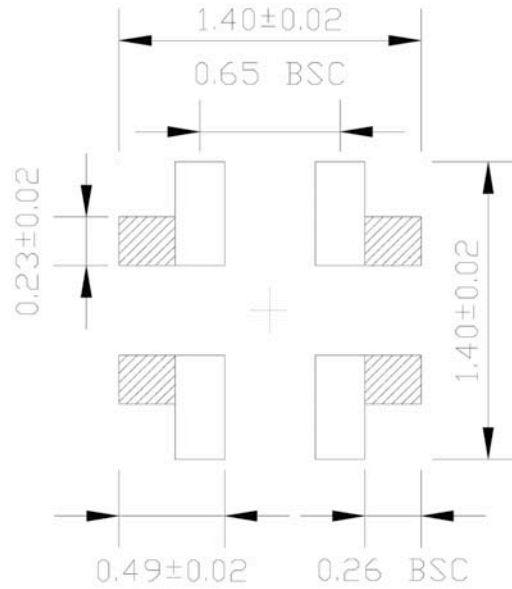

 Optional (For Thermal Improvement)

Disclaimer: This is only a recommendation based on information available to Micrel from its suppliers. Actual land pattern may have to be significantly different due to various materials and processes used in PCB assembly. Micrel makes no representation or warranty of performance based on the recommended land pattern."

Suggested Landing Pattern for 4 Pin (1.2mm x 1.2mm) MLF[®]

MICREL, INC. 2180 FORTUNE DRIVE SAN JOSE, CA 95131 USA

TEL +1 (408) 944-0800 FAX +1 (408) 474-1000 WEB <http://www.micrel.com>

The information furnished by Micrel in this data sheet is believed to be accurate and reliable. However, no responsibility is assumed by Micrel for its use. Micrel reserves the right to change circuitry and specifications at any time without notification to the customer.

Micrel Products are not designed or authorized for use as components in life support appliances, devices or systems where malfunction of a product can reasonably be expected to result in personal injury. Life support devices or systems are devices or systems that (a) are intended for surgical implant into the body or (b) support or sustain life, and whose failure to perform can be reasonably expected to result in a significant injury to the user. A Purchaser's use or sale of Micrel Products for use in life support appliances, devices or systems is a Purchaser's own risk and Purchaser agrees to fully indemnify Micrel for any damages resulting from such use or sale.

© 2008 Micrel, Incorporated.